





Features of your new air conditioner

Contents

Cool Summer Offer

On those hot sweltering summer days and long restless nights, there is no better escape from the heat than the cool comforts of home. Your new air conditioner brings an end to exhausting hot summer days and lets you rest. Beat the heat with your own air conditioner this summer.

Cost Efficient System

Your new air conditioner not only provides maximum cooling power in the summer, but also can be an efficient heating method in the winter with the advanced "Heat pump" system. "Heat pump" system is 3 times more efficient compare to the other electrical heating appliance, so you can further reduce its running cost. Now, meet year-round needs with one air conditioner.

Look for Everywhere

The elegant and harmonious design gives priority to the esthetics of your space and complements any of your existing interior décor. With its soft color and rounded-edge shape, the new air conditioner adds class to any room. Enjoy what your air conditioner offers both functionally and esthetically.

good'sleep function

good'sleep function allows you to set a comfortable sleep temperature while saving energy and having sound sleep.

USING PARTS

Safety precautions	3
Checking before use	6
Checking the name of the parts	7
Checking the remote controller	8
Basic function	10
Adjusting the air flow direction	12
Using the Turbo function	12
good'sleep mode	13
Setting the On/Off timer	14
Using the Smart Saver function	15
Using the Quiet function	16
Using the Auto Clean function	16
Cleaning the air conditioner	17
Maintaining the air conditioner	19
Troubleshooting	20

INSTALLATION PARTS

Safety precautions	22
Choosing the installation location	23
Accessories	26
Fixing the installation plate	27
Connecting the assembly cable	28
Installing and connecting the assembly pipe of the indoor unit	30
Purging the indoor unit	31
Cutting or extending the pipe	31
Installing and connecting the drain hose of the indoor unit	33
Changing direction of the drain hose	34
Installing and connecting the drain hose of the outdoor unit	35
Purging the connected pipes	35
Performing the gas leak tests	38
Fixing the indoor unit in place	39
Fixing the outdoor unit in place	39
Final check and trial operation	40
Pump down procedure (when removing the product)	40
How to connect your extended power cables	41
Sub PCB installation(optional)	42
Remocon module installation (optional)	43









USING PARTS

Safety precautions

Before using your new air conditioner, please read this manual thoroughly to ensure that you know how to safely and efficiently operate the extensive features and functions of your new appliance.



Because the following operating instructions cover various models, the characteristics of your air conditioner may differ slightly from those described in this manual. If you have any questions, call your nearest contact center or find help and information online at www.samsung.com.

Important safety symbols and precautions:

 WARNING	Hazards or unsafe practices that may result in severe personal injury or death.		
 CAUTION	Hazards or unsafe practices that may result in minor personal injury or property damage.		
	Follow directions.		Unplug the power plug from the wall socket.
	Do NOT attempt.		Do NOT disassemble.
	Make sure the machine is grounded to prevent electric shock.		

FOR INSTALLATION

WARNING

-  **Plug the power cord into a wall socket with the power specifications of the product or higher and use the socket for this appliance only. In addition, do not use an extension cord.**
 - ▶ Sharing a wall socket with other appliances using a power strip or extending the power cord may result in electric shock or fire.
 - ▶ Do not use an electric transformer. It may result in electric shock or fire.
 - ▶ If the voltage/frequency/rated current condition is different, it may cause fire.
- The installation of this appliance must be performed by a qualified technician or service company.**
 - ▶ Failing to do so may result in electric shock, fire, explosion, problems with the product, or injury.
- Install a switch and circuit breaker dedicated to the air conditioner.**
 - ▶ Failing to do so may result in electric shock or fire.
- Fix the outdoor unit firmly so that the electric part of the outdoor unit is not exposed.**
 - ▶ Failing to do so may result in electric shock or fire.
-  **Do not install this appliance near a heater, inflammable material. Do not install this appliance in a humid, oily or dusty location, in a location exposed to direct sunlight and water (rain drops). Do not install this appliance in a location where gas may leak.**
 - ▶ This may result in electric shock or fire.
- Never install the outdoor unit in a location such as on a high external wall where it could fall.**
 - ▶ If the outdoor unit falls, it may result in injury, death or property damage.
-  **This appliance must be properly grounded. Do not ground the appliance to a gas pipe, plastic water pipe, or telephone line.**
 - ▶ Failure to do so may result in electric shock, fire, an explosion, or other problems with the product.
 - ▶ Never plug the power cord into a socket that is not grounded correctly and make sure that it is in accordance with local and national codes.

FOR INSTALLATION

CAUTION

-  **This appliance should be positioned in such a way that it is accessible to the power plug.**
 - ▶ Failing to do so may result in electric shock or fire due to electric leakage.
- Install your appliance on a level and hard floor that can support its weight.**
 - ▶ Failing to do so may result in abnormal vibrations, noise, or problems with the product.
- Install the draining hose properly so that water is drained correctly.**
 - ▶ Failing to do so may result in water overflowing and property damage.
- When installing the outdoor unit, make sure to connect the draining hose so that draining is performed correctly.**
 - ▶ The water generated during the heating operation by the outdoor unit may overflow and result in property damage. In particular, in winter, if a block of ice falls, it may result in injury, death or property damage.



Safety precautions

FOR POWER SUPPLY

WARNING

- ❗ **Remove all foreign substances such as dust or water from the power plug terminals and contact points using a dry cloth on a regular basis.**
 - ▶ Unplug the power plug and clean it with a dry cloth.
 - ▶ Failing to do so may result in electric shock or fire.
- Plug the power plug into the wall socket in the right direction so that the cord runs towards the floor.**
 - ▶ If you plug the power plug into the socket in the opposite direction, the electric wires within the cable may be damaged and this may result in electric shock or fire.
- When the appliance or power plug or power cord is damaged, contact your nearest service center.**
- ⊘ **Plug the power plug into the wall socket firmly. Do not use a damaged power plug, damaged power cord or loose wall socket.**
 - ▶ This may result in electric shock or fire.
- Do not pull the power cord, when unplugging the power plug.**
 - ▶ Unplug the power plug by holding the plug.
 - ▶ Failing to do so may result in electric shock or fire.
- Do not pull or excessively bend the power cord. Do not twist or tie the power cord. Do not hook the power cord over a metal object, place a heavy object on the power cord, insert the power cord between objects, or push the power cord into the space behind the appliance.**
 - ▶ This may result in electric shock or fire.

FOR POWER SUPPLY

CAUTION

- ⚡ **When not using the air conditioner for a long period of time or during a thunder/lightning storm, cut the power at the circuit breaker.**
 - ▶ Failing to do so may result in electric shock or fire.

FOR USING

WARNING

- ❗ **If the appliance is flooded, please contact your nearest service center.**
 - ▶ Failing to do so may result in electric shock or fire.
- If the appliance generates a strange noise, a burning smell or smoke, unplug the power plug immediately and contact your nearest service center.**
 - ▶ Failing to do so may result in electric shock or fire.
- In the event of a gas leak (such as propane gas, LP gas, etc.), ventilate immediately without touching the power plug. Do not touch the appliance or power cord.**
 - ▶ Do not use a ventilating fan.
 - ▶ A spark may result in an explosion or fire.
- To reinstall the air conditioner, please contact your nearest service center.**
 - ▶ Failing to do so may result in problems with the product, water leakage, electric shock, or fire.
 - ▶ A delivery service for the product is not provided. If you reinstall the product in another location, additional construction expenses and an installation fee will be charged.
 - ▶ Especially, when you wish to install the product in an unusual location such as in an industrial area or near the seaside where it is exposed to the salt in the air, please contact your nearest service center.
- ⊘ **Do not touch the power plug or the circuit breaker with wet hands.**
 - ▶ This may result in electric shock.
- Do not unplug the power plug or turn the air conditioner off with the circuit breaker while it is operating.**
 - ▶ Plugging the power plug into the wall outlet or turning the air conditioner on from the circuit breaker may cause a spark and result in electric shock or fire.
- After unpacking the air conditioner, keep all packaging materials well out of the reach of children, as packaging materials can be dangerous to children.**
 - ▶ If a child places a bag over its head, it may result in suffocation.
- Do not insert your fingers or foreign substances into the outlet when the air conditioner is operating.**
 - ▶ Take special care that children do not injure themselves by inserting their fingers into the product.
- Do not touch the air flow blade with your hands or fingers during the heating operation.**
 - ▶ This may result in electric shock or burns.
- Do not insert your fingers or foreign substances into the air inlet/outlet of the air conditioner.**
 - ▶ Take special care that children do not injure themselves by inserting their fingers into the product.
- Do not strike or pull the air conditioner with excessive force.**
 - ▶ This may result in fire, injury, or problems with the product.





FOR USING

WARNING

- Do not place an object near the outdoor unit that allows children to climb onto the machine.**
 - ▶ This may result in children seriously injuring themselves.
- Do not use this air conditioner for long periods of time in badly ventilated locations or near infirm people.**
 - ▶ Since this may be dangerous due to a lack of oxygen, Open a window at least once an hour.
- If any foreign substance such as water has entered the appliance, cut the power by unplugging the power plug and turning the circuit breaker off and then contact your nearest service center.**
 - ▶ Failing to do so may result in electric shock or fire.
- Do not attempt to repair, disassemble, or modify the appliance yourself.**
 - ▶ Do not use any fuse (such as cooper, steel wire, etc.) other than the standard fuse.
 - ▶ Failing to do so may result in electric shock, fire, problems with the product, or injury.

FOR USING

CAUTION

- Do not place objects or devices under the indoor unit.**
 - ▶ Water dripping from the indoor unit may result in fire or property damage.
- Check that the installation frame of the outdoor unit is not broken at least once a year.**
 - ▶ Failing to do so may result in injury, death or property damage.
- Max current is measured according to IEC standard for safety and current is measured according to ISO standard for energy efficiency.**
- Do not stand on top of the appliance or place objects (such as laundry, lighted candles, lighted cigarettes, dishes, chemicals, metal objects, etc.) on the appliance.**
 - ▶ This may result in electric shock, fire, problems with the product, or injury.
- Do not operate the appliance with wet hands.**
 - ▶ This may result in electric shock.
- Do not spray volatile material such as insecticide onto the surface of the appliance.**
 - ▶ As well as being harmful to humans, it may also result in electric shock, fire or problems with the product.
- Do not drink the water from the air conditioner.**
 - ▶ The water may be harmful to humans.
- Do not apply a strong impact to the remote controller and do not disassemble the remote controller.**
- Do not touch the pipes connected with the product.**
 - ▶ This may result in burns or injury.
- Do not use this air conditioner to preserve precision equipment, food, animals, plants or cosmetics, or for any other unusual purposes.**
 - ▶ This may result in property damage.
- Avoid directly exposing humans, animals or plants from the air flow from the air conditioner for long periods of time.**
 - ▶ This may result in harm to humans, animals or plants.
- This appliance is not intended for use by persons (including children) with reduced physical, sensory or mental capabilities, or lack of experience and knowledge, unless they have been given supervision or instruction concerning use of the appliance by a person responsible for their safety. Children should be supervised to ensure that they do not play with the appliance.**

FOR CLEANING

WARNING

- Do not clean the appliance by spraying water directly onto it. Do not use benzene, thinner or alcohol to clean the appliance.**
 - ▶ This may result in discoloration, deformation, damage, electric shock or fire.
- Before cleaning or performing maintenance, unplug the air conditioner from the wall socket and wait until the fan stops.**
 - ▶ Failing to do so may result in electric shock or fire.

FOR CLEANING

CAUTION

- Take care when cleaning the surface of the heat exchanger of the outdoor unit since it has sharp edges.**
 - ▶ To avoid cutting your fingers, wear thick cotton gloves when cleaning it.
- Do not clean the inside of the air conditioner by yourself.**
 - ▶ For cleaning inside the appliance, contact your nearest service center.
 - ▶ When cleaning the internal filter, refer to the descriptions in the 'Cleaning the air conditioner' section.
 - ▶ Failure to do so may result in damage, electric shock or fire.



Checking before use

Operation ranges

The table below indicates the temperature and humidity ranges the air conditioner can be operated within. Refer to the table for efficient use.

Mode	Indoor temperature	Outdoor temperature	Indoor humidity
Cooling	61°F~86°F (16°C~30°C)	14°F~115°F (-10°C~46°C)	Relative humidity 80% or less
Heating	81°F(27°C) or less	5°F~76°F (-15°C~24°C)	-
Dry	65°F~90°F (18°C~32°C)	14°F~115°F (-10°C~46°C)	-

- ▶ If the air conditioner operates in cooling mode for long period of time in high humidity area, dew may be formed.
- ▶ If the outdoor temperature goes down to 23°F(-5°C), heating capacity may decrease as much as 60%~70% of specified capacity according to the using conditions.

Maintaining your air conditioner

Internal protections via the unit control system

- ▶ This internal protection operates if an internal fault occurs in the air conditioner.

Type	Description
Against cold air	The internal fan will be off to against cold air when the heat pump is heating.
De-ice cycle	The internal fan will be off to defrost ice when the heat pump is heating.
Anti-protection of internal battery	The compressor will be off to protect internal battery when the air conditioner operates in Cool mode.
Protect compressor	The air conditioner does not start operating immediately to protect the compressor of the outdoor unit after it has been started.



- If the heat pump is operating in Heat mode, De-ice cycle is actuated to remove frost from an outdoor unit that may have deposited at low temperatures.
The internal fan is switched off automatically and restarted only after the de-ice cycle is completed.



Checking the name of the parts

Your air conditioner may slightly look different from illustration shown above depending on your model.

Main parts

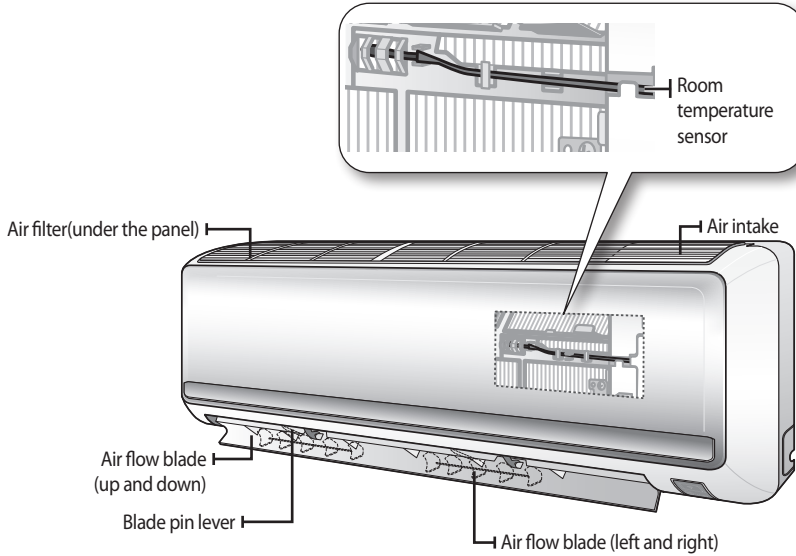

ENGLISH

Display

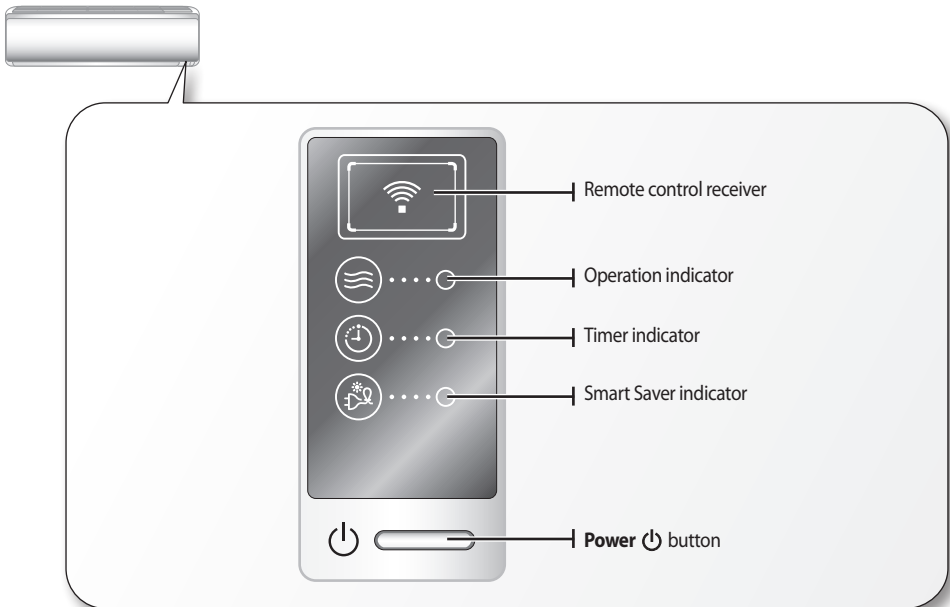

Checking the remote controller

- Point the remote controller towards the remote controller receiver of the indoor unit.
- When you properly press the button on the remote controller, you will hear beep sound from the indoor unit and a transmit indicator (📶) appears on the remote controller display.

Remote controller buttons

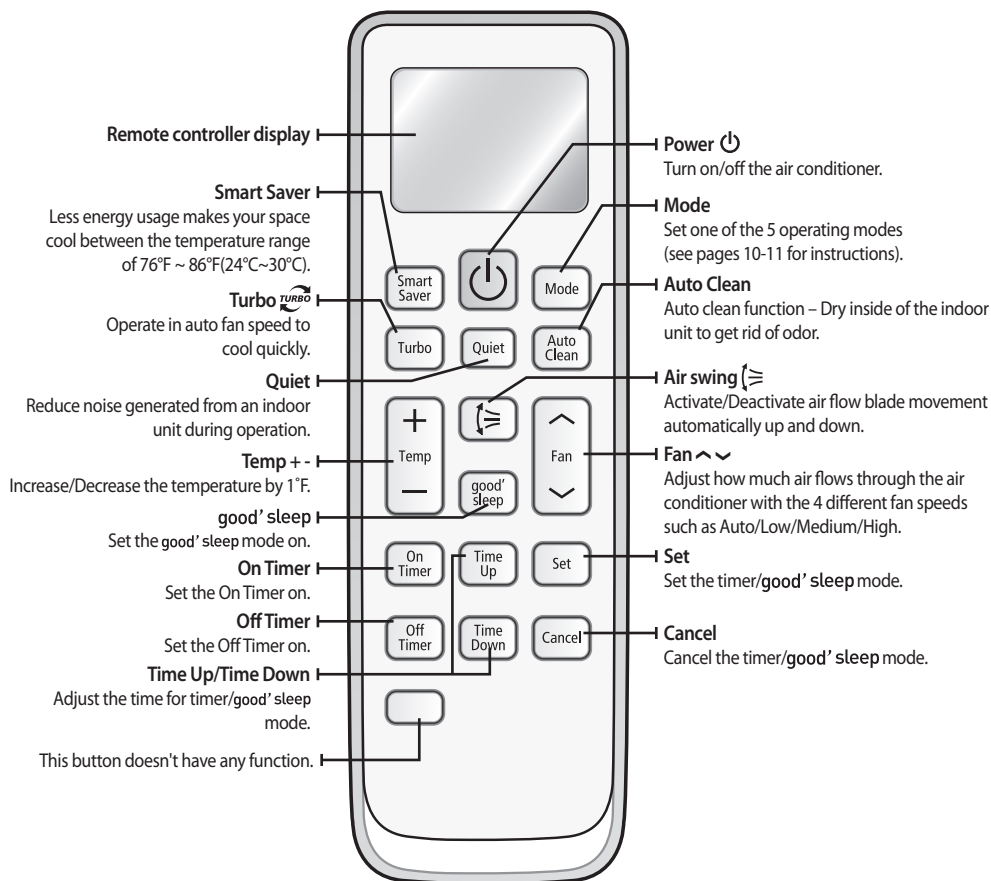

• Make sure that the water does not get to the remote controller.



Remote controller display

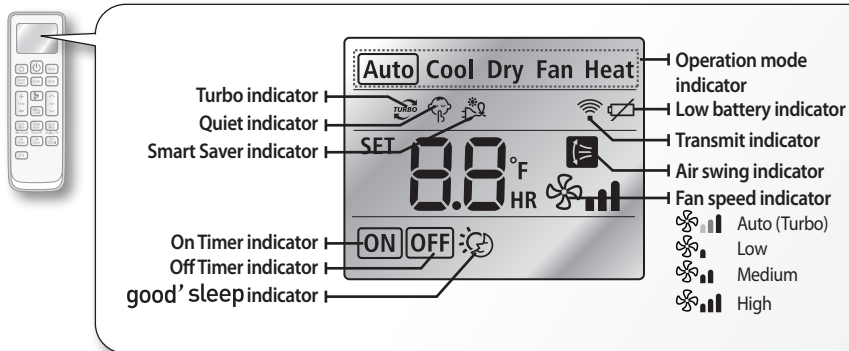

Battery changing time

When the battery is exhausted, (🔋) will be displayed in the remote controller display. When the icon appears, change the batteries. The remote controller requires two 1.5V AAA type batteries.

Storing the remote controller

When you do not use the remote controller for long time, remove the batteries from the remote controller and store it.

Inserting the batteries



1. Push the lever as arrow indicates on the rear side of the remote controller and pull up.

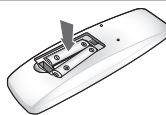

2. Insert two AAA batteries. Check and match the "+" and "-" signs accordingly. Make sure you have inserted the batteries in correct position.

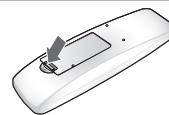

3. Close the cover by place it back to its original position. You should hear click sound when the cover is locked properly.



- The signal may not be received well of electronic lighting style fluorescent lamps such as inverter fluorescent lamps are in the same space.
- If other electrical products operate by the remote controller, call your nearest contact center.





Basic function

Basic operation is an operation mode that can be selected by pressing the **Mode** button.

Auto

In Auto mode, the air conditioner will automatically set the temperature and fan speed depending on the room temperature detected by the room temperature.

Cool

In Cool mode, the air conditioner will cool your room. You can adjust the temperature and the fan speed to feel cooler in hot season.

- If current outside temperatures are much higher than the selected indoor temperature, it may take time to bring the inner temperature to the desired coolness.
- Quiet mode (🌀, 📶, 🗣️) makes the noise quieter during operating the indoor unit in the Cool mode.

Dry

The air conditioner in Dry mode acts like a dehumidifier by removing moisture from the indoor air. Dry mode makes the air feel refreshing in a humid climate.

To maximize the dehumidification capacity during the Dry operation, the air conditioner could be operating at lower or higher temperature than the remote controller set temperature.

Fan

Fan mode can be selected to ventilate your room. Fan mode will be helpful to refresh the stale air in your room.

Heat

The air conditioner heats as well as cools. Warm your room with this versatile appliance in the cold of winter.

- Fan may not operate for about 3~5 minutes at the beginning to prevent any cold blasts while the air conditioner is warming up.
- Quiet mode (🌀, 📶, 🗣️) makes the noise quieter during operating the indoor unit in the Heat mode.
- Since the air conditioner heats the room by taking heat energy from outdoor air, the heating capacity may decrease when outdoor temperature is extremely low.
Use an additional heating appliance in combination with the air conditioner if you feel the air conditioner heats insufficiently.











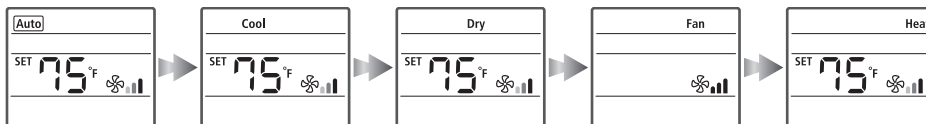







Press the  button to turn on the air conditioner.

Press the  button to set the operating mode.

- Each time you press the **Mode** button, the mode will change in order of Auto, Cool, Dry, Fan and Heat.



Press the  button to set the desired fan speed.

Auto	 (Auto)
Cool	 (Auto),  (Low),  (Med),  (High)
Dry	 (Auto)
Fan	 (Low),  (Med),  (High)
Heat	 (Auto),  (Low),  (Med),  (High)

Press the  button to adjust the temperature.

Auto	You can adjust the desired temperature by 1°F within the range of 61°F~86°F(16°C~30°C).
Cool	You can adjust the desired temperature by 1°F within the range of 61°F~86°F(16°C~30°C).
Dry	You can adjust the desired temperature by 1°F within the range of 65°F~86°F(18°C~30°C).
Fan	Temperature adjustment is not possible.
Heat	You can adjust the desired temperature by 1°F within the range of 61°F~86°F(16°C~30°C).



NOTE

- Air flow can be adjusted manually.(see page 12 for instructions.)





Adjusting the air flow direction

Air flow can be directed to your desired position.

Vertical air flow

Air flow blades move up and down.

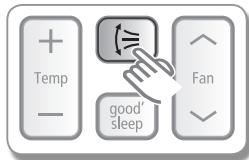

Press the **Air swing** button on the remote controller.

- ▶ Air swing indicator will be on and air flow blades move up and down continuously to circulate the air.
- ▶ Press the **Air swing** button on the remote controller again, to keep the air flow direction in a constant position.

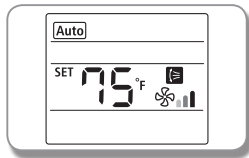

Horizontal air flow

Make sure one of the blade pin lever that stick out of the air flow blades are not broken.



Move the blade pin lever left or right to keep the air flow direction in a constant position you prefer.

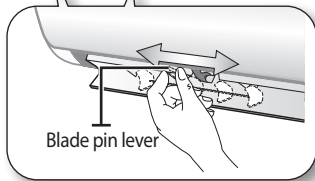

- Be extremely careful with your fingers while adjusting the Horizontal air flow direction. There is a potential risk of personal injury when the unit is mishandled.

Using the Turbo function

Turbo function will be helpful to cool your room quickly and effectively.



Press the **Turbo** button on the remote controller during **Cool mode**.

- ▶ Turbo indicator appears on the remote controller display and the air conditioner operates in Turbo function for 30 minutes.

Cancel Press the **Turbo** button once again.

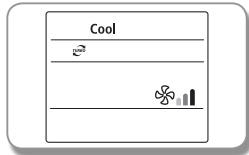

- Turbo function is only available in Cool mode.
- If you press the **Mode** button while the Turbo function is on, it will cancel the function.
- Temperature/Fan speed cannot be adjusted while using this function.



good' sleepmode

For a comfortable sleep, the air conditioner will operate it Fall asleep ▷ Sound sleep ▷ Wake up from **good' sleep** mode.

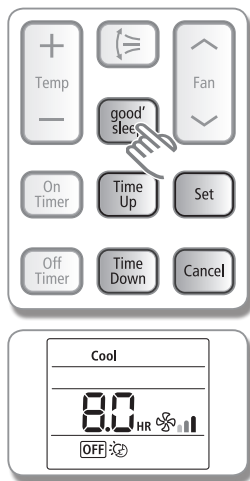

When the air conditioner is on and in cool/heat mode

1. Press the **good' sleep** button on the remote controller.
 - ▶ **good' sleep** indicator appears and Off timer indicator starts blinking on the remote controller display.
2. Press the **Time Up** or **Time Down** button to set the time.
 - ▶ You can set the time in half hourly unit from 30 minutes ~ 3 hours and hour unit from 3 hours ~ 12 hours.
 - ▶ Operating hour can be set from minimum 30 minutes to maximum 12 hours.
 - ▶ Default operation hour is set to 8 hours.
3. Press the **Set** button to active it on.
 - ▶ Off timer indicator stops blinking and reserved time will be displayed for 3 seconds. Then the air conditioner operates in good'sleep(Cool/Heat) mode.
 - ▶ If you don't press **Set** button within 10 seconds after pressing the **good' sleep** or **Time Up** or **Time Down** button, the air conditioner will return to previous status.

ENGLISH

Cancel Press the **Cancel** button once again.

	You can set the desired temperature by 1°F in the range of 61°F~86°F(16°C~30°C).
	Fan speed will be adjusted automatically according to the good' sleep mode. However, If you select good' sleep mode while heating operation is on, you can adjust fan speed.
	Air flow direction will be adjusted automatically according to the good' sleep mode. However, if you select good' sleep mode while heating operation is on, you can adjust air flow direction.

Temperature and fan speed changes in good' sleep mode

- Fall asleep: Eases you into sleep by dropping the temperature.
- Sound sleep: Relaxes your body and raises your temperature slightly.
- Wake up from **good' sleep** mode: Allows you to wake up from comfortable intermittent air and it makes you feel refreshed.



- Set Off timer in **good' sleep** mode over 5 hours. You fell disturbed sleep if the **good' sleep** is set too short or long because the default is set to 8-hour-operation.
- If the **good' sleep** mode is set less than 4 hours, the operation will stop at the same time.
 If the **good' sleep** mode is set over 5 hours, it will run as Wake up stage from the last one hour before it stops.
- Recommended set temperature is between 77°F~81°F (25°C~27°C) for cooling and 70°F~73°F (21°C~23°C) for heating.

Setting the On/Off timer

You can set the air conditioner to turn on/off automatically at desired time.

Setting On timer while the air conditioner is off / Off timer while the air conditioner is on

Setting On timer

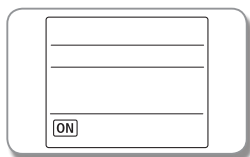
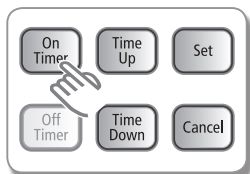

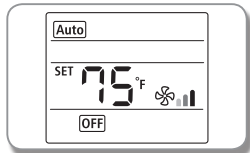
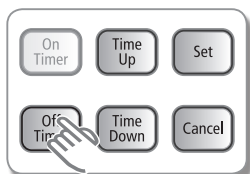

1. Press the **On Timer/Off Timer** button.
 - ▶ On/Off timer indicator will blink on the remote controller display.
2. Press the **Time Up** or **Time Down** button to set the time.
 - ▶ You can set the time in half hourly unit from 30 minutes ~ 3 hours and hour unit from 3 hours ~ 24 hours.
 - ▶ Operating hour can be set from minimum 30 minutes to maximum 24 hours.
3. Press the **Set** button to active it on.
 - ▶ On timer indicator stops blinking and reserved time will be displayed for 3 seconds.
 - ▶ If you don't press **Set** button within 10 seconds after selecting the time the air conditioner will return to previous status. Check On timer or Off timer indicator and  indicator on the indoor unit.

Setting Off timer



Cancel Press the **Cancel** button.

Additional options available in On timer mode

	You can select from Auto/Cool/Dry/Fan/Heat.
	You can adjust the fan speed in Cool/Fan/Heat mode.
	You can adjust the temperature in Auto/Cool/Dry/Heat mode.



- Only the latest setting timer will be applied between the On Timer/Off Timer and good' sleep Off timer functions.
- After setting the timer, the set time will be displayed for 3 seconds before it disappears.



Combining On Timer and Off Timer

If the air conditioner is on	If the air conditioner is off
<p><i>Preset time on On timer is longer than Off timer</i></p> <p>Ex) On timer : 3 hours, Off timer : 1 hour</p> <ul style="list-style-type: none"> - The air conditioner will operate the Off timer after 1 hour from the moment you have set the timer. Your air conditioner will turn on after 2 hours. 	<p><i>Preset time on On timer is shorter than Off timer</i></p> <p>Ex) On timer : 3 hours, Off timer : 5 hours</p> <ul style="list-style-type: none"> - The air conditioner will operate On timer after 3 hours from the moment you have set the timer. Your air conditioner will remain on for 2 hours and then turn off automatically.



- On timer and Off timer setting time should be different from each other.
- Press the **Cancel** button on the remote controller while timer combination is on. Both of the On and Off timer will be canceled and the indicator will disappear.

Using the Smart Saver function

This function will set the temperature range limit to help you save energy while the air conditioner is operating in Cool mode.

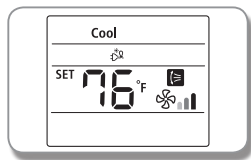
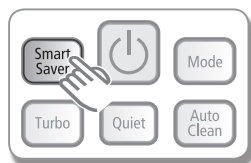

Press the **Smart Saver** button on the remote controller while the air conditioner is operating in Cool mode.

- ▶ Smart Saver indicator and air swing indicator appears automatically on the remote controller display. The air flow blades move up and down.
- ▶ If the current set temperature is lower than 76°F(24°C), it will automatically raise to 76°F(24°C).

Cancel Press the **Smart Saver** button once again.



- Smart Saver function is only available in Cool mode.
- When Smart Saver function is activated, temperature range will be limited to 76°F~86°F (24°C~30°C).
- If the desired temperature is lower than 76°F(24°C), turn off the Smart Saver function by pressing the **Smart Saver** button again.
- Temperature/Fan speed can also be adjusted (see page 11 for instructions).
- Air flow can be adjusted manually (see page 12 for instructions).
- If you press the **Mode** button while the Smart Saver function is on, it will cancel the function.



Using the Quiet function

You can reduce the noise generated from an indoor unit.

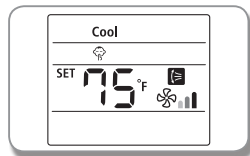
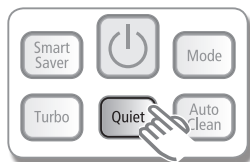

Press the **Quiet** button on the remote controller while the air conditioner is operating in **Cool/Heat mode**.

- ▶ Quiet indicator appears on the remote controller display.
- ▶ The indoor unit will operate more quietly.

Cancel Press the **Quiet** button once again.

NOTE • If using a multi system, this function will work only when the Quiet function is set on all operated indoor units.

Using the Auto Clean function

Auto clean function will prevent from growing mold by eliminating the moisture inside of the indoor unit. Your indoor unit evaporates the moisture inside of the unit. Activate this function to provide you with more clean and healthier air.

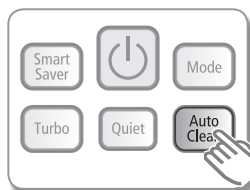

Press the **Auto Clean** button.

When the air conditioner is turned off,

- ▶ The Auto clean indicator on the indoor unit display appears and the Auto cleaning function runs.

When the air conditioner is turned on,

- ▶ After stopping the air conditioner operation, the Auto clean indicator on the indoor unit display appears and the Auto cleaning function runs.

※ Auto Cleaning time can vary, depending on the previously used mode.

Auto(cool), Cool, Dry mode : approximately 30 minutes.

Auto(heat), Heat, Fan mode : approximately 15 minutes.

Cancel Press the **Auto Clean** button once again.

NOTE • When the air conditioner is turned on, the Auto clean function runs after stopping the air conditioner operation.



Cleaning the air conditioner



- **Make sure the power is turned off and unplugged from the wall socket when cleaning the air conditioner.**

Cleaning the indoor unit

- ▶ Wipe the surface of the unit with a slightly wet or dry cloth when needed.



- Contact the service center when you clean the indoor unit heat exchanger because it needs to be disassembled.



- Do not clean the display using alkaline detergent.
- Do not use sulfuric acid, hydrochloric acid, organic solvents (such as thinner, kerosene and acetone etc.) to clean the surface of the product or put any stickers on it. They may damage the surface of the air conditioner.

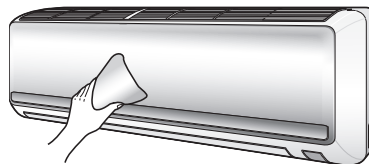

Cleaning the outdoor unit heat exchanger

- ▶ When dust accumulates on the heat exchanger, it may decrease cooling performance. Therefore, clean it regularly.
- ▶ Spray water to clean the dust.



- If it is difficult to clean the outdoor unit heat exchanger on your own, contact service center.



- Be careful with the sharp edges on the outdoor unit heat exchanger.

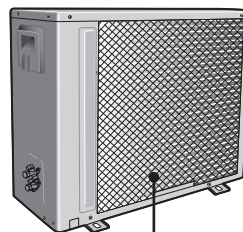

Heat exchanger
(Illustration may differ slightly depending on the models)

Opening the panel

Tightly grab top of the front panel and pull it down to open. Then slightly lift the panel up.

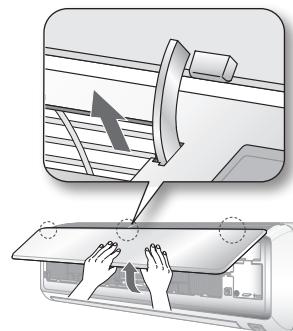



Cleaning the air conditioner

Removing the Air filter

Grab the handle and lift it up. Then, pull the Air filter towards you and slide it down.

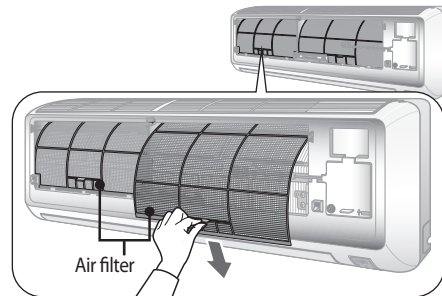

Cleaning the air filter

Washable foam based air filter captures large particles from the air. The filter is cleaned with a vacuum or by hand washing.

Open the panel and put the Air filter out.

Clean the Air filter with a vacuum cleaner or soft brush. If dust is too heavy, rinse it with running water.



Insert the Air filter back in its original position and close the front panel.

Dry the Air filter in a ventilated area.

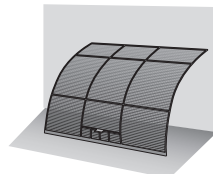

- Clean the Air filter every 2 weeks or when the filter clean reminder lights up. Cleaning term may differ depending on the usage and environmental conditions. In dusty area, clean it once a week.
- If you turn off the air conditioner by pressing **Power** button, the filter clean reminder will be turned off.
- If the Air filter dries in a confined (or humid) area, odors may generate. If it occurs, re-clean and dry it in a well-ventilated area.





Maintaining the air conditioner

If the air conditioner will not be used for an extended period of time, dry the air conditioner to maintain it in best condition.

1. Dry the air conditioner thoroughly by operating in Fan mode for 3 to 4 hours and disconnect the power plug. There may be internal damage if moisture is left in components.
2. Before using the air conditioner again, dry the inner components of the air conditioner again by running in Fan mode for 3 to 4 hours. This helps remove odors which may have generated from dampness.

Periodical checks

Refer to the following chart to maintain the air conditioner properly.

Type	Description	Every 2 weeks	Every 3 months	Every 4 months	Once a year
Indoor unit	Clean the air filter (1)	●			
	Clean the condensate drain pan (2)				●
	Thoroughly clean the heat exchanger (2)				●
	Clean the condensate drain pipe (2)			●	
	Replace the remote controller batteries (1)				●
Outdoor unit	Clean the heat exchanger on the outside of the unit (2)			●	
	Clean the heat exchanger on the inside of the unit (2)				●
	Clean the electric components with jets of air (2)				●
	Verify that all the electric components are firmly tightened (2)				●
	Clean the fan (2)				●
	Verify that all the fan assembly is firmly tightened (2)				●
	Clean the condensate drain pan (2)				●

● : This check mark requires checking the indoor/outdoor unit periodically, following to the description to maintain the air conditioner properly.



- (1) The described operations should be performed more frequently if the area of installation is very dusty.
 (2) These operations must always be performed by qualified personnel. For more detailed information, see the installation part in the manual.





Troubleshooting

Refer to the following chart if the air conditioner operates abnormally. This may save time and unnecessary expenses.

PROBLEM	SOLUTION
The air conditioner does not work at all.	<ul style="list-style-type: none"> • Check power status and then operate the air conditioner again. • Plug in or switch on the circuit breaker and then operate the air conditioner again. • Check if you have set the Off Timer. Operate the air conditioner again by pressing the Power button.
The temperature adjustment is not working.	<ul style="list-style-type: none"> • Check if you have selected Fan/Turbo mode. In these modes, desired temperature is set to auto and you cannot adjust the temperature.
Cool/Warm air does not come out of the air conditioner.	<ul style="list-style-type: none"> • Check if the set temperature is higher(during Cool mode)/lower(during Heat mode) than the current temperature. Press the Temp + or - button on the remote controller to change the set temperature. • Check if the Air filter is blocked by dirt. If there is a lot of dust on the Air filter, cooling(heating) performance may decrease. Clean them frequently. • Check if the outdoor unit is covered or installed near the obstacle. Take the cover off and take the obstacle away. • If you want to operate the air conditioner in the sunlight, cover the outdoor unit using curtains or etc. • Check if the air conditioner is operating in De-ice mode. When the ice formed in winter or the outdoor temperature is too low, the air conditioner operates in De-ice mode automatically. In De-ice mode, indoor fan stops and cool air does not come out. • If the doors or windows are open, it may cause bad cooling (heating) performance. Close the doors and windows. • Check if the air conditioner has just been turned on after stopping cooling(heating) operation. In this case, just a fan will run to protect the outdoor unit compressor. • Check if the pipe length is too long. When the pipe length exceeds maximum allowable pipe length, cooling (heating) performance may decrease.
Air flow adjustment is not working.	<ul style="list-style-type: none"> • Check if you have selected Auto/Dry/good' sleep mode. In these modes, desired temperature is set to auto and you cannot adjust the temperature.
Fan speed adjustment is not working.	<ul style="list-style-type: none"> • Check if you have selected Auto/Dry/Turbo/good' sleep mode. In these mode, fan speed is set to Auto and you cannot adjust the fan speed.
Remote controller is not working.	<ul style="list-style-type: none"> • Check if your batteries are depleted. • Make sure nothing is blocking your remote controller sensor. • Check that there are strong lighting apparatus near the air conditioner. Strong light which comes from fluorescent bulbs or neon signs may interrupt the electric waves.
Timer function does not set.	<ul style="list-style-type: none"> • Check if you press the Set button on the remote controller after you have set the time.
The indicator is blinking continuously.	<ul style="list-style-type: none"> • Press the Power  button or disconnect the power plug/switch off the auxiliary power switch. If the indicator is still blinking, contact the service center.
Odors permeate in the room during operation.	<ul style="list-style-type: none"> • Check if the appliance is running in a smoky area. Ventilate the room or operate the air conditioner in Fan mode for 1~2 hours. (We do not use smelly components in the air conditioner.)





PROBLEM	SOLUTION
Error is indicated.	<ul style="list-style-type: none">When an indoor unit indicator blinks, contact the nearest service center.
Noise is generated.	<ul style="list-style-type: none">Depending on the status of the air conditioner usage, noise can be heard when refrigerant flow movement changes. It is normal.
Smoke is generated from the outdoor unit.	<ul style="list-style-type: none">If may not be a fire but it can be a steam generated by the defrost operation from outdoor heat exchanger during Heat mode in winter.
Water is dropping from the outdoor unit piping connection.	<ul style="list-style-type: none">Water may be generated because of the temperature difference. It is normal.



INSTALLATION PARTS

※ In this manual, you may find model names written in simplified forms as indicated in following table.

Model Names	Included Models	Remark
AQ**VFU*	AQ*09VFU*, AQ*12VFU*, AQ*18VFU*, AQ*24VFU*, AQ*36VFU*	Grouping was done by series.
09	AQ*09VFU*	Grouping was done by capacity.
12	AQ*12VFU*	
18	AQ*18VFU*	
24	AQ*24VFU*	
36	AQ*36VFU*	

Safety precautions

Carefully follow the precautions listed below because they are essential to guarantee the safety of the equipment.

- Always disconnect the air conditioner from the power supply before servicing it or accessing its internal components.
- Verify that installation and testing operations are performed by qualified personnel.
- Verify that the air conditioner is not installed in an easily accessible area.

General information

- ▶ Carefully read the content of this manual before installing the air conditioner and store the manual in a safe place in order to be able to use it as reference after installation.
- ▶ For maximum safety, installers should always carefully read the following warnings.
- ▶ Store the operation and installation manual in a safe location and remember to hand it over to the new owner if the air conditioner is sold or transferred.
- ▶ This manual explains how to install an indoor unit with a split system with two SAMSUNG units. The use of other types of units with different control systems may damage the units and invalidate the warranty. The manufacturer shall not be responsible for damages arising from the use of non compliant units.
- ▶ The air conditioner is compliant with the requirements of the Low Voltage Directive (72/23/EEC), the EMC Directive (89/336/EEC) and the Directive on pressurized equipment (97/23/EEC).
- ▶ The manufacturer shall not be responsible for damage originating from unauthorized changes or the improper connection of electric and requirements set forth in the "Operating limits" table, included in the manual, shall immediately invalidate the warranty.
- ▶ The air conditioner should be used only for the applications for which it has been designed: the indoor unit is not suitable to be installed in areas used for laundry.
- ▶ Do not use the units if damaged. If problems occur, switch the unit off and disconnect it from the power supply.
- ▶ In order to prevent electric shocks, fires or injuries, always stop the unit, disable the protection switch and contact SAMSUNG's technical support if the unit produces smoke, if the power cable is hot or damaged or if the unit is very noisy.
- ▶ Always remember to inspect the unit, electric connections, refrigerant tubes and protections regularly. These operations should be performed by qualified personnel only.
- ▶ The unit contains moving parts, which should always be kept out of the reach of children.
- ▶ Do not attempt to repair, move, alter or reinstall the unit. If performed by unauthorized personnel, these operations may cause electric shocks or fires.
- ▶ Do not place containers with liquids or other objects on the unit.
- ▶ All the materials used for the manufacture and packaging of the air conditioner are recyclable.
- ▶ The packing material and exhaust batteries of the remote controller(optional) must be disposed of in accordance with current laws.
- ▶ The air conditioner contains a refrigerant that has to be disposed of as special waste. At the end of its life cycle, the air conditioner must be disposed of in authorized centers or returned to the retailer so that it can be disposed of correctly and safely.





Installing the unit

IMPORTANT: When installing the unit, always remember to connect first the refrigerant tubes, then the electrical lines.

Always disassemble the electric lines before the refrigerant tubes.

- ▶ Upon receipt, inspect the product to verify that it has not been damaged during transport. If the product appears damaged, **DO NOT INSTALL** it and immediately report the damage to the carrier or retailer (if the installer or the authorized technician has collected the material from the retailer.)
- ▶ After completing the installation, always carry out a functional test and provide the instructions on how to operate the air conditioner to the user.
- ▶ Do not use the air conditioner in environments with hazardous substances or close to equipment that release free flames to avoid the occurrence of fires, explosions or injuries.
- ▶ To prevent injury when accidentally touching the indoor unit fan, install the indoor unit at least 8.2ft(2.5m) above the floor.
- ▶ The air conditioner should be used only for the applications for which it has been designed : the indoor unit is not suitable to be installed in areas used for laundry.
- ▶ Our units must be installed in compliance with the spaces indicated in the installation manual to ensure either accessibility from both sides or ability to perform routine maintenance and repairs. The units' components must be accessible and that can be disassembled in conditions of complete safety either for people or things.
For this reason, where it is not observed as indicated into the Installation Manual, the cost necessary to reach and repair the unit (in safety, as required by current regulations in force) with slings, trucks, scaffolding or any other means of elevation won't be considered in-warranty and charged to end user.

Power supply line, fuse or circuit breaker

- ▶ Always make sure that the power supply is compliant with current safety standards. Always install the air conditioner in compliance with current local safety standards.
- ▶ Always verify that a suitable grounding connection is available.
- ▶ Verify that the voltage and frequency of the power supply comply with the specifications and that the installed power is sufficient to ensure the operation of any other domestic appliance connected to the same electric lines.
- ▶ Always verify that the cut-off and protection switches are suitably dimensioned.
- ▶ Verify that the air conditioner is connected to the power supply in accordance with the instructions provided in the wiring diagram included in the manual.
- ▶ Always verify that electric connections (cable entry, section of leads, protections...) are compliant with the electric specifications and with the instructions provided in the wiring scheme.
Always verify that all connections comply with the standards applicable to the installation of air conditioners.

Choosing the installation location

Indoor unit

- ▶ Where airflow is not blocked
- ▶ Where cool air can be distributed throughout the room
- ▶ Install the refrigerant piping length and the height difference of both indoor and outdoor units as indicated in the installation diagram
- ▶ Wall that prevents vibration and is strong enough to hold the product weight
- ▶ Out of the direct sunlight
- ▶ 1m or more away from the TV or radio (to prevent the screen from being distorted or noise from being generated)
- ▶ As far away as possible from the fluorescent and incandescent lights (so that the remote controller can be operated well)
- ▶ A place where the air filter can be replaced easily





Choosing the installation location

Outdoor Unit

- ▶ Where it is not exposed to strong wind
- ▶ Well ventilated and dustless places
- ▶ Out of the direct sunlight and rain
- ▶ Where neighbors are not annoyed by operation sound or hot air
- ▶ Solid wall or support that prevents vibration and is strong enough to hold the product weight
- ▶ Where there is no risk of flammable gas leakage
- ▶ When installing the unit at a high place be sure to fix the unit legs
- ▶ 9.84ft(3m) or more away from the TV or radio (to prevent the screen from being distorted or noise from being generated)
- ▶ Install the unit horizontally
- ▶ Place where drained water does not become any problem.
- ▶ Place with no plants (especially climbing plants) and where small animal can not access.



- Avoid the following places to prevent malfunction of the unit
 - Where there is machine oil
 - Salty environment such as seaside areas
 - Where sulfide gas exists
 - Other special atmosphere areas

Observe the clearances and maximum lengths as seen in the picture below when installing the air conditioner.

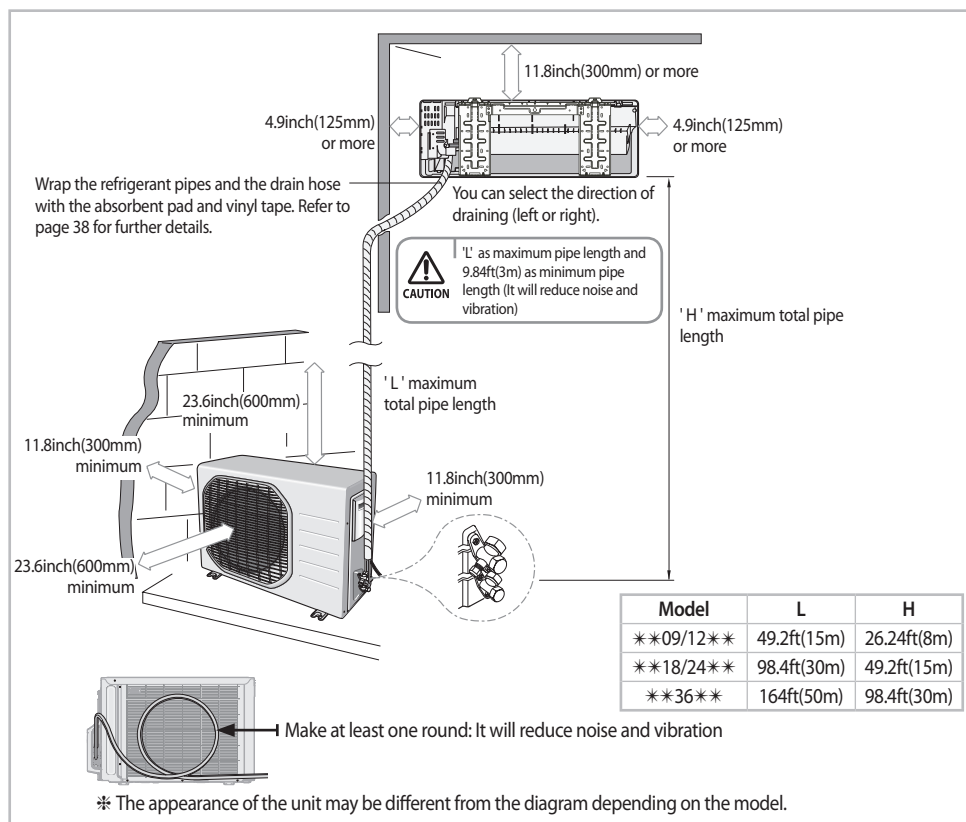



Space Requirements for Outdoor Unit

When installing 1 outdoor unit

◆ Figure Description

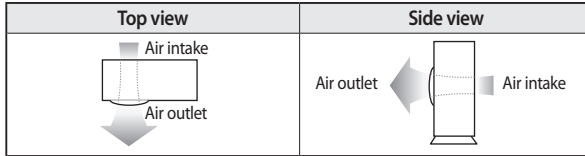

◆ Air flow direction.

(Unit : inch)

◆ When the air outlet is opposite the wall

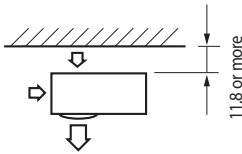

◆ When the air outlet is towards the wall

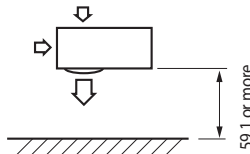

◆ When 3 sides of the outdoor unit are blocked by the wall

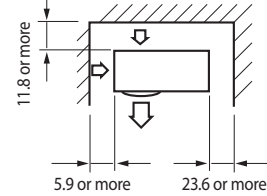

◆ The upper part of the outdoor unit and the air outlet is towards the wall

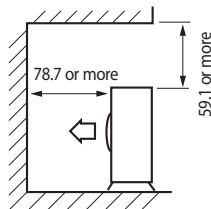

◆ The upper part of the outdoor unit and the air outlet is opposite the wall

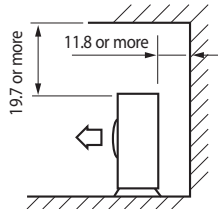

◆ When the walls are blocking front and the rear side of the outdoor unit

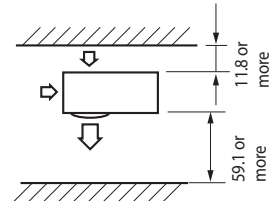

When installing more than 1 outdoor unit

(Unit : inch)

◆ When the air outlet is towards the wall

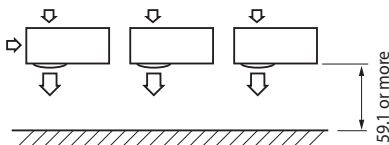

◆ When 3 sides of the outdoor unit are blocked by the wall

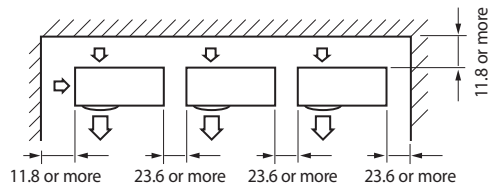



Choosing the installation location

(Unit : inch)

◆ When the walls are blocking front and the rear side of the outdoor units

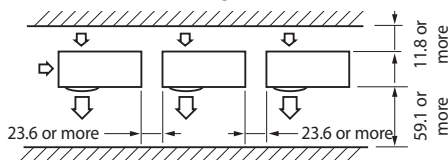

◆ When front and rear side of the outdoor unit is towards the wall

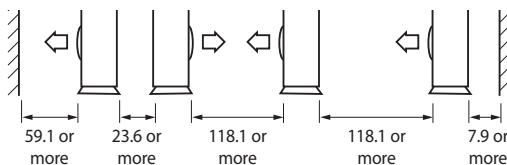

◆ When the upper part of the outdoor unit and the air outlet is opposite the wall

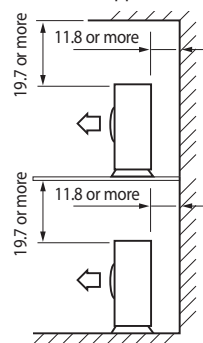

- If installation is done in inappropriate space, unit may generate sound and cause bad effect on the product.
- Installation must be done in level and in a place where vibration will not cause any effect.

Accessories

The following accessories are supplied with the air conditioner:



- The number of each accessory is indicated in parentheses.

Accessories in the indoor unit case

Installation Plate (1) **09/12/18/24** 	Installation Plate (1) **36** 	Remote controller (1) 	Batteries for Remote controller (2) 	User's & Installation Manual (1)
---	--------------------------------------	---------------------------	---	--------------------------------------

Accessories in the outdoor unit case

2-wire Assembly Cable (1) 	3-wire Assembly Cable (1) 	Drain Plug (1) 	Rubber Leg (4)
-------------------------------	-------------------------------	--------------------	--------------------



- The flare nuts are attached to the end of each pipe of an evaporator or a service port. Use the nuts when connecting the pipes.
- The 2(3)-wire assembly cable is optional. If it is not supplied, use the standard cable.
- The drain plug and rubber leg are only included when the air conditioner is supplied without the assembly pipe as seen in the picture.





Optional accessories

The following connection accessories are optional. If they are not supplied, you should obtain them before installing the air conditioner.

Insulated Assembly Pipe, Ø1/4inch (Ø6.35mm) (1) 	Insulated Assembly Pipe, Ø3/8inch(9.52mm) (1) **09/12** 	Insulated Assembly Pipe, Ø1/2inch(12.70mm) (1) **18** 	Insulated Assembly Pipe, Ø5/8inch(15.88mm) (1) **24/36** 	PE T3 Foam Tube Insulation (1) 	Vinyl Tapes (2) 	Drain Plug (1)
Rubber Legs (4) 	Pipe Clamps A (3) 	Pipe Clamps B (3) 	Cement Nails (6) 	M0.16 x 0.98 (M4 x 25) Tapped Screws (6) 	Drain Hose, length 6.56ft(2m) (1) 	Putty 100g (1)
Foam Insulation(1) 	Wired remote controller (1) 	Sub COMM PBA 	<div style="border: 1px solid black; padding: 5px;"> <p>CAUTION</p> <ul style="list-style-type: none"> If these accessories are supplied, they will be in the accessory box. Wired remote controller is optional. It has no Filter Reset function in this model. At cool mode, when wireless Remote controller temp setting is from 61°F~64°F, wired Remote controller can display the setting temp correctly, but can't set TEMP below from 64°F to 61°F. </div>			

Tools required for installation

General Tools

- Vacuum Pump(Backward flowing prevention)
- Manifold Gauge
- Stud Finder
- Torque Wrench
- Pipe Cutter
- Reamer
- Pipe Bender
- Spirit Level
- Screw Driver
- Spanner
- Drill
- Wrench
- Measuring Tape

Tools for test operations

- Thermometer
- Resistance Meter
- Electroscope

Fixing the installation plate

You can select the direction of the drain hose depending on where you want to install the indoor unit. Therefore before fixing the installation plate to a wall or a window frame, you must determine the position of the 65mm hole through which the cable, pipe and hose pass to connect the indoor unit to the outdoor unit.

When facing the wall, the pipe and cable can be connected from the:

- Right (A)
- Left (B)
- Underside_right (C)
- Rear_right or left (D)

※ Direction of pipe

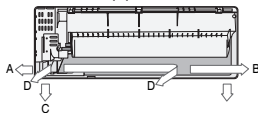

- Determine the position of the pipe and drain hose hole as seen in the picture and drill the hole with an inner diameter of 65mm so that it slants slightly downwards.

(Unit : inch(mm))

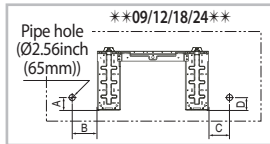

Model	A	B	C	D
09/12	1.06 (27)	4.72 (120)	2.68 (68)	1.06 (27)
18/24	1.34 (34)	5.51 (140)	2.68 (68)	1.34 (34)

(Unit : inch(mm))

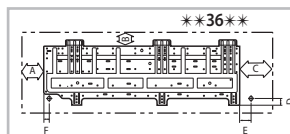

Model	A	B	C	D
36	6.14 (156)	2.64 (67)	14.33 (364)	1.36 (34.5)
			E	F
			2.54 (64.5)	0.77 (19.5)



- Make sure to drill only one hole after choosing the direction of the pipe.





Fixing the installation plate

2. Fix the indoor unit.

If you fix the indoor unit on a wall

(1) Fix the installation plate to the wall giving attention to the weight of the indoor unit.



- If you mount the plate to a concrete wall using plastic anchors, make sure that gaps between the wall and the plate, created by projected anchor, is less than 0.79inch(20mm).

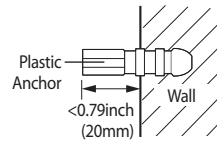

If you fix the indoor unit on a window frame

- (1) Determine the positions of the wooden uprights to be attached to the window frame.
- (2) Attach the wooden uprights to the window frame giving attention to the weight of the indoor unit.
- (3) Attach the installation plate to the wooden upright using tapping screws.

If you fix the indoor unit on a gypsum board

- (1) Use stud finder to find out locations of the studs.
- (2) Fix the plate hanger on two studs.



- Search for other spots if there are less than two studs, or the distance between the studs are different from the plate hanger.
- Fix the installation plate without inclining to one side.



- Make sure that a wall can withstand the weight of the product. If you install the product in a place where it is not strong enough to withstand the product weight, the unit could fall and cause injury.

Connecting the assembly cable

Cable specification

Model	Use	AWG	Cross sectional area (mm ²)
09/12/18/24	Main power supply 3-wire Power cable	13 or fewer	2.5 or more
	Indoor power supply 3-wire power cable	15 or fewer	1.5 or more
	2-wire assembly cable	15 or fewer	1.5 or more
36	Main power supply 3-wire Power cable	10 or fewer	4 or more
	Indoor power supply 3-wire power cable	15 or fewer	1.5 or more
	2-wire assembly cable	15 or fewer	1.5 or more



- Connect the power cable to the auxiliary circuit breaker. If every pole fails to connect to the power supply, it must be incorporated in a wire with a contact opening of ≥ 0.118 inch(3mm).

Connecting the cable

Electrical work

- (1) For electrical and earth works, comply with the 'technical standards of electrical installations' and the the 'wiring regulations' of the Electricity Enterprises Act.
- (2) Tighten the terminal block screw to under 0.87ft·lb(12kgf·cm).
- (3) Precautions when connecting terminal blocks of the indoor unit
 - ▶ Before connecting, make sure the connecting part of the terminal socket is facing upwards.

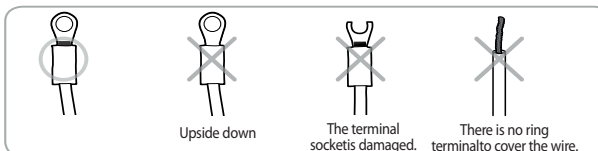



- ▶ There must be no space between the terminal and the screw when connected.
 - Any remaining space may become a fire hazard due to overheating of the electrical contact.

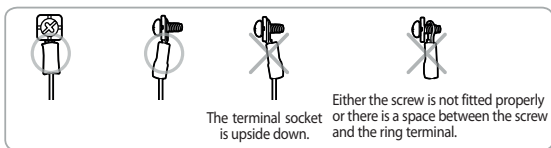

- For the terminal block wiring, use a wire with a ring terminal socket only. Regular wires without a ring terminal socket may become a fire hazard due to overheating of the electrical contact during a wiring work.

- ※ When you install the unit, make first refrigerant connections and then electrical connections. Connect the air conditioner to grounding system before performing the electrical connection. If unit is uninstalled, first disconnect electrical cables, then refrigerant connections.

A 24.6ft(7.5m) pipe is supplied with the air conditioner. If the outdoor unit is more than 24.6ft(7.5m) away from the indoor unit, you must extend the cable. The maximum length of the cable is 15(**09/12**)/20(**18/24/36***) meters.

1. Extend the assembly cable if necessary.



- Do not connect two or more different cables to extend the length. It may cause fire.

2. Open the front grille.
3. Remove the screw securing the connector cover.
4. Pass the assembly cable through the rear of the indoor unit and connect the assembly cable to terminals. (Refer to the picture below)



- Each wire is labeled with the corresponding terminal number.

5. Pass the other end of the cable through the 2.56inch(65mm) hole in the wall.
6. Close the connector cover by tightening the screw carefully.
7. Close the front grille.
8. Remove the terminal board cover on the side of the outdoor unit.
9. Connect the cables to the terminals as seen in the picture.



- Each wire is labeled with the corresponding terminal number.

Indoor unit

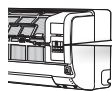

Outdoor unit

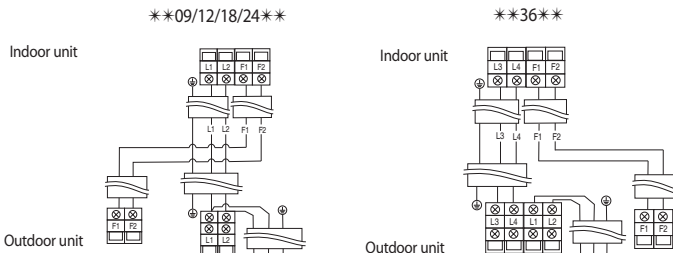

※ The appearance of the unit may be different from the diagram depending on the model.



Connecting the assembly cable



- End of the wire must be circular.
- After connecting the cables, make sure terminal numbers on the indoor/outdoor unit matches.
- Screws on terminal block must not be unscrewed with the torque less than 0.87ft·lb(12kgf·cm).

10. Connect the grounding conductor to the grounding terminals.

11. Close the terminal board cover by tightening the screw carefully.



- In Russia and Europe, consult with the supply authority to determine the supply system impedance before installation.



- Connect the wires firmly so that wires can not be pulled out easily. (If they are loose, it could cause burn-out of the wires.)
- Connect the wires according to color codes, referring to the wiring diagram.
- The power cable and the interconnection cable should be selected according to the specification in page 28.

Installing and connecting the assembly pipe of the indoor unit

Connect indoor and outdoor units with field-supplied copper pipes by means of flare connections. Use insulated seamless refrigeration grade pipe only, (Cu DHP type according to ISO1337), degreased and deoxidized, suitable for operating pressures of at least 4200 kPa and for burst pressure of at least 20700 kPa. Under no circumstances must sanitary type copper pipe be used.

There are 2 refrigerant pipes of different diameters:

- The smaller one is for the liquid refrigerant
- The larger one is for the gas refrigerant

A short pipe is already fitted to the air conditioner. You may need to extend the pipe using the assembly pipe (optional).

The connection procedure for the refrigerant pipe varies according to the exit position of the pipe when facing the wall:

- Right(A)
- Left(B)
- Underside(C)
- Rear

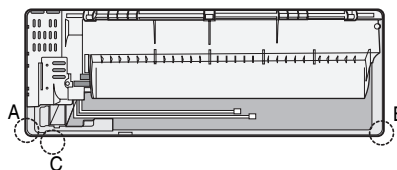

1. Cut out the appropriate knock-out piece (A, B, C) on the rear of the indoor unit unless you connect the pipe directly from the rear.

2. Smooth the cut edges.

3. Remove the protection caps of the pipes and connect the assembly pipe to each pipe. Tighten the nuts first with your hands, and then with a torque wrench, applying the following torque:

Outer Diameter	Torque
ø1/4 inch (ø6.35mm)	10.1~12.3 ft·lb (140~170 kgf·cm)
ø3/8 inch (ø9.52mm)	18.1~20.3 ft·lb (250~280 kgf·cm)
ø1/2 inch (ø12.70 mm)	27.5~30.4 ft·lb (380~420 kgf·cm)
ø5/8 inch (ø15.88mm)	31.8~34.7 ft·lb (440~480 kgf·cm)
ø3/4 inch (ø19.05mm)	71.6~87.5 ft·lb (990~1210 kgf·cm)
ø7/8 inch (ø22.23 mm)	71.6~87.5 ft·lb (990~1210 kgf·cm)



- If you want to shorten or extend the pipes, refer to page 31~32.



4. Cut off the remaining foam insulation.
5. If necessary, bend the pipe to fit along the bottom of the indoor unit.
Then pull it out through the appropriate hole.
 - ▶ The pipe should not project from the rear of the indoor unit.
 - ▶ The bending radius should be 3.94inch(100 mm) or more.
6. Pass the pipe through the hole in the wall.
7. For further details on how to connect to the outdoor unit and purge the air, refer to page 35~37.



- The pipe will be insulated and fixed permanently into position after finishing the installation and the gas leak test; refer to page 38 for further details.



- Tighten the flare nut with torque wrench according to specified method.
If the flare nut is over-tightened, the flare may break and cause refrigerant gas leakage.
- DO NOT WALL UP THE PIPE CONNECTION !
All refrigerant pipe connection must be easy accessible and serviceable.

Purging the indoor unit

The indoor unit is supplied with inert gas (nitrogen).

Before installing the unit, check if nitrogen gas flow out of indoor unit.

If this one isn't true, DO NOT INSTALL THE UNIT since leakage could be inside the indoor unit.

1. Unscrew the caps at the end of each pipe.

- ▶ All inert gas exhausts from the indoor unit.



- To prevent dirt or foreign substances from getting into the pipes during installation, do NOT remove the caps completely until you are ready to connect the pipes.



- The remaining air in the Refrigeration cycle, which contains moisture, may cause malfunction on the compressor.
- Always contact the service center or a professional installation agency for product installation.

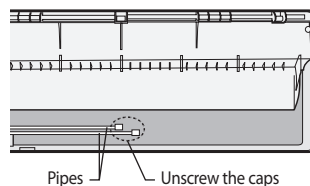

Cutting or extending the pipe

A 24.6ft(7.5m) pipe is supplied with the air conditioner.

The length of the pipe can be:

- Extended up to : see table page 24
- Shorten up to: see page 24



- If you need a pipe longer than 24.6ft(7.5m):
 - You must extend the assembly cable.
 - You must add refrigerant to the pipes; otherwise, the indoor unit may freeze.



Cutting or extending the pipe

1. Make sure that you have all the required tools (pipe cutter, reamer, flaring tool and pipe holder).
2. If you want to shorten the pipe, cut it using a pipe cutter, ensuring that the cut edge remains at 90° with the side of the pipe (see below examples of correct and incorrect cut edges).

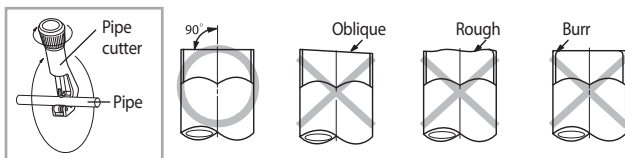

3. To prevent a gas leak, remove all burrs at the cut edge of the pipe using a reamer.



• Face the pipe down while removing the burrs to make sure that burrs do not get in to the pipe.

4. Put a flare nut slightly into the pipe and modify the flare.

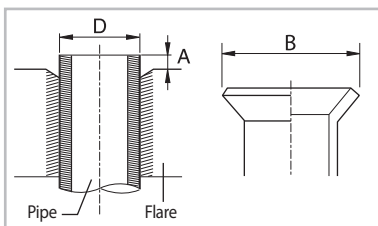

Outer Diameter (D)	Depth (A)	Flaring Size (B)
ø1/4inch(6.35mm)	0.051inch(1.3mm)	0.354inch(9.0mm)
ø3/8inch(9.52mm)	0.071inch(1.8mm)	0.512inch(13.0mm)
ø1/2inch(12.70mm)	0.079inch(2.0mm)	0.638inch(16.2mm)
ø5/8inch(15.88mm)	0.087inch(2.2mm)	0.760inch(19.3mm)
ø3/4inch(19.05mm)	0.087inch(2.2mm)	0.886inch(22.5mm)
ø7/8 inch(22.23mm)	0.087inch(2.2mm)	1.012inch(25.7mm)

5. Check if you flared the pipe correctly (see examples of incorrectly flared pipes below).



6. Align the pipes to connect them easily. Tighten the flare nuts first with your hands, and then with a torque wrench, applying the following torque:

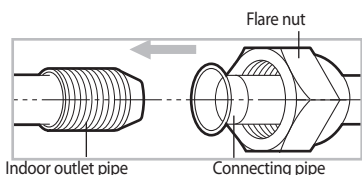

Outer Diameter	Torque
ø1/4inch(6.35mm)	10.1~12.3 ft·lb (140~170 kgf·cm)
ø3/8inch(9.52mm)	18.1~20.3 ft·lb (250~280 kgf·cm)
ø1/2inch(12.70mm)	27.5~30.4 ft·lb (380~420 kgf·cm)
ø5/8inch(15.88mm)	31.8~34.7 ft·lb (440~480 kgf·cm)
ø3/4inch(19.05mm)	71.6~87.5 ft·lb (990~1210 kgf·cm)
ø7/8 inch(22.23mm)	71.6~87.5 ft·lb (990~1210 kgf·cm)



• Excessive torque can be cause of gas leakage. In case brazing the pipe, the nitrogen gas must be blown into the pipe (50 Pa). The joint must be accessible and serviceable.

7. For further details on how to connect to the outdoor unit and purge the air, refer to page 35~37.



• Tighten the flare nut with torque wrench according to specified method.
If the flare nut is over-tightened, the flare may break and cause refrigerant gas leakage.



Installing and connecting the drain hose of the indoor unit

When installing the drain hose for the indoor unit, check if condensation draining is adequate.

When passing the drain hose through the 2.56inch(65mm) hole drilled in the wall, check the followings:

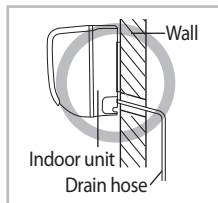

The drain hose must NOT be bent.

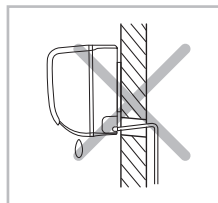

The drain hose must NOT slant upwards.

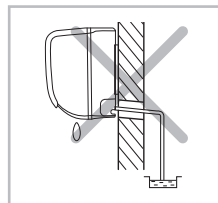

The end of the drain hose must NOT be placed under water.

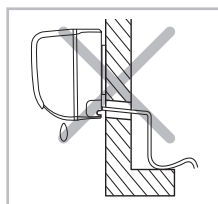

The drain hose must not be bent.

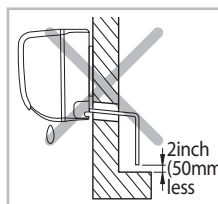

Keep a clearance of at least 2inch(50mm) between the end of the drain hose and the ground.

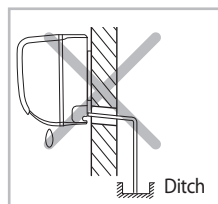

Do not place the end of the drain hose in a hollow.

Drain hose installation

1. If necessary, connect the 6.6ft(2m) extension drain hose to the drain hose.
2. If you use the extension drain hose, insulate the inside of the extension drain hose with a shield.
3. Fit the drain hose into 1 of 2 drain hose holes, then fix the end of the drain hose tightly with a clamp.



If you do not use the other drain hose hole, block it with a rubber stopper.

4. When extending the Drain Hose, hold the end of Drain Hose and Extended Hose, rotate and insert the drain hose into Extended hose for 0.59~0.79inch(15~20 mm). Make sure the two hoses are firmly connected, there is no water leakage.
5. Connect the Drain Hose after using Foam Insulation to wrap the Extended Hose. Then, Use vinyl tape to wrap the each side of connection by 0.79inch(20mm).

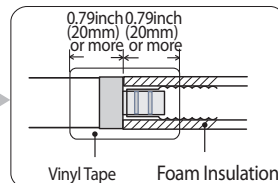
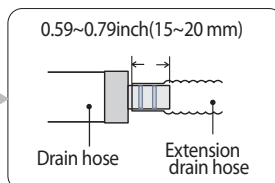
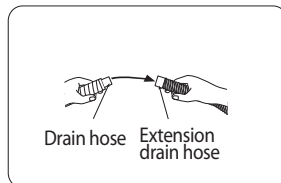
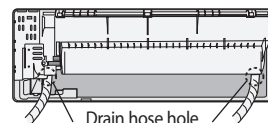

6. Pass the drain hose under the refrigerant pipe, keeping the drain hose tight.
7. Pass the drain hose through the hole in the wall. Check if it slants downwards as seen in the picture.
8. Using natural drainage method, check the drainage is normal.

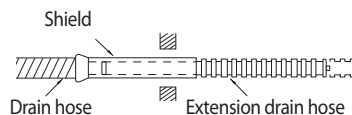



Installing and connecting the drain hose of the indoor unit



- The hose will be fixed permanently into position after finishing the installation and the gas leak test; refer to page 39 for further details.



- Make sure the installed direction of the drain hose is correct. Inadequate installation may cause condensate water leakage.
- If the drain hose is routed inside the room, insulate the hose so that dripping condensation does not damage the furniture or floors.
- **DO NOT WALL UP THE DRAIN HOSE CONNECTION !**
Drain hose connection must be easy accessible and serviceable.

Changing direction of the drain hose

Change the direction only when it is necessary.

1. Detach the rubber cap with the plier.
2. Detach the drain hose by pulling it and turning to the left.
3. Insert the drain hose by fixing it with the screw into the groove of the drain hose and the outlet of the drain pan.
4. Attach the rubber cap with a screwdriver by turning it to the right until it fixes to the end of the groove.
5. Check for leakage on both side of the drain outlet.

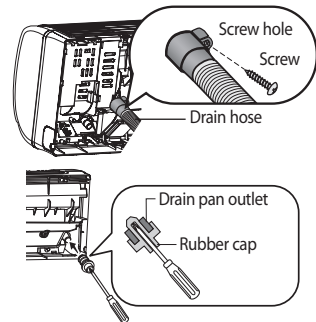

Pour the water in direction of arrow. * Direction of the drained water

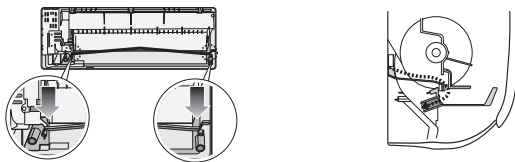

- Make sure the indoor unit is in upright position when you pour water to check for leakage. Make sure that the water does not overflow onto the electrical part.





Installing and connecting the drain hose of the outdoor unit

While heating, ice may accumulate. During the process of defrosting, check if condensation draining is adequate. For adequate draining, do the following:

1. Insert the drain plug into the drain hole on the underside of the outdoor unit.



To avoid drain plug from contacting the ground, secure gap between the ground and the bottom surface of the outdoor unit.

2. Connect a drain hose to the drain plug.



In areas with heavy snow fall, piled snow could block the air intake. To avoid this incident, install a frame that is higher than estimated snow fall. In addition, install a snow-proof hood to avoid snow from piling on the outdoor unit.

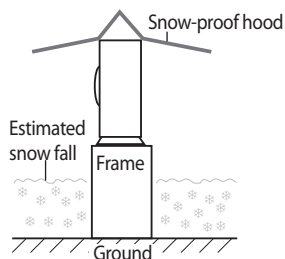
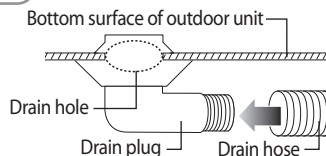
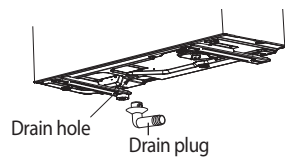

Purging the connected pipes

The outdoor unit is loaded with sufficient R410A refrigerant. Do not vent R410A into atmosphere: it is a fluorinated greenhouse gas, covered by Kyoto Protocol, with a Global Warming Potential (GWP) = 1975.

You should purge the air in the indoor unit and in the pipe. If air remains in the refrigerant pipes, it affects the compressor. It may cause reduction of cooling capacity and malfunction. Refrigerant for air purging is not charged in the outdoor unit. Use Vacuum Pump as seen in the picture.



When installing, make sure there is no leakage. When recovering the refrigerant, ground the compressor first before removing the connection pipe. If the refrigerant pipe is not properly connected and the compressor works with the service valve open, the pipe inhales the air and it makes the pressure inside of the refrigerant cycle abnormally high. It may cause explosion and injury.

1. Connect each assembly pipe to the appropriate valve on the outdoor unit and tighten the flare nut.
2. Tighten the flare nut first with your hands, and then with a torque wrench, applying the following torque:

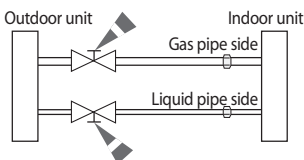



Purging the connected pipes



- Excessive torque can be cause of gas leakage.



- Make the electrical connection and leave the system into "stand by mode". Do not turn on the system!
This is necessary for better vacuum operation (full OPEN position of Electronic Expansion Valve - EEV -).

- Connect the charging hose of the low-pressure side of manifold gauge to a gas service port as seen in the picture.
- Open the valve of the low pressure side of manifold gauge counterclockwise.
- Purge the air in the connected pipes using the vacuum pump for about 15 minutes.
 - Make sure that pressure gauge shows -0.1MPa(-76cmHg) after about 10 minutes.
This procedure is very important to avoid a gas leak.
 - Close the valve of the low pressure side of manifold gauge clockwise.
 - Turn off the vacuum pump.
 - Check for 2 minutes if there is any pressure change.
 - Remove the hose of the low pressure side of manifold gauge.
- Set a valve cork of liquid and gas service port to the open position.
- Mount the valve stem nuts and the service port cap to the valve, and tighten them at the torque of 13.2ft-lb(183kgf-cm) with a torque wrench.
- Check for a gas leak paying particular attention to the 3-way valve's stem nuts and to the service port cap (Refer to page 38).

Outer Diameter	Torque
ø1/4inch(6.35mm)	10.1~12.3 ft-lb (140~170 kgf-cm)
ø3/8inch(9.52mm)	18.1~20.3 ft-lb (250~280 kgf-cm)
ø1/2inch(12.70mm)	27.5~30.4 ft-lb (380~420 kgf-cm)
ø5/8inch(15.88mm)	31.8~34.7 ft-lb (440~480 kgf-cm)
ø3/4inch(19.05mm)	71.6~87.5 ft-lb (990~1210 kgf-cm)
ø7/8 inch(22.23mm)	71.6~87.5 ft-lb (990~1210 kgf-cm)

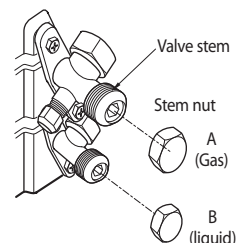
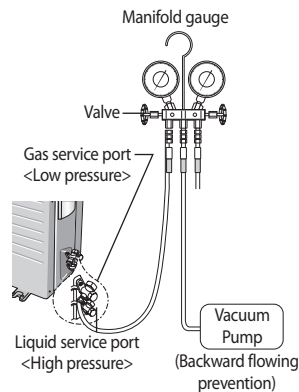

Adding Refrigerant

Add refrigerant charge according to table below:

If you use a pipe longer than 24.6ft(7.5m),

'Ag of refrigerant R410A must be added for each extra meter.

If you use a pipe shorter than 24.6ft(7.5m),

The purge time is normal.

Refer to the Service Manual for further details.

Model	A
09/12/18/24	15
36	40



- The remaining air in the Refrigeration cycle, which contains moisture, may cause malfunction on the compressor.
- Always contact the service center or a professional installation agency for product installation.





Important information regulation regarding the refrigerant used

This product contains fluorinated greenhouse gases covered by the Kyoto Protocol.

Do not vent gases into the atmosphere.

Refrigerant type	GWP value
R410A	1975

※ GWP=Global Warming Potential

1. Please fill in with indelible ink,

- ▶ ① the factory refrigerant charge of the product,
- ▶ ② the additional refrigerant amount charged in the field and
- ▶ ①+② the total refrigerant charge. on the refrigerant charge label supplied with the product.



- a. Factory refrigerant charge of the product:
see unit name plate
- b. Additional refrigerant amount charged in the field (Refer to the above information for the quantity of refrigerant replenishment.)
- c. Total refrigerant charge
- d. Refrigerant cylinder and manifold for charging

Contains fluorinated greenhouse gases covered by the Kyoto Protocol.

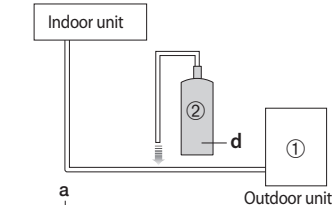

① = ($\frac{\quad}{b}$) kg ①+② = ($\frac{\quad}{c}$) kg
② = ($\frac{\quad}{b}$) kg



- The filled-out label must be adhered in the proximity of the product charging port (e.g. onto the inside of the stop valve cover).

Charging the refrigerant under conditions of liquid by using a liquid pipe

R410A is a mixed type of refrigerant. It is necessary for recharging under conditions of liquid. When recharging refrigerant from the refrigerant cylinder to the equipment, follow the instructions below.

1. Before recharging, check whether the cylinder has a siphon or not.

There are two ways to recharge the refrigerant.

Cylinder with siphon

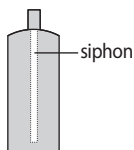

- ▶ Charge the refrigerant standing the cylinder upright.

Cylinder without siphon



- ▶ Charge the refrigerant turning the cylinder upside down.



- If R410A refrigerant is charged with gas, the composition of the charged refrigerant changes and the characteristics of the equipment vary.
- During the measuring operation of refrigerant quantity added use an electronic balance. If cylinder doesn't have siphon, upset it.





Performing the gas leak tests

Make sure to check for gas leaks before completing the installation process (connecting the assembly pipe and hose between indoor unit and outdoor unit, insulating the cables, hose and pipe, and fixing the indoor unit to the installation plate).

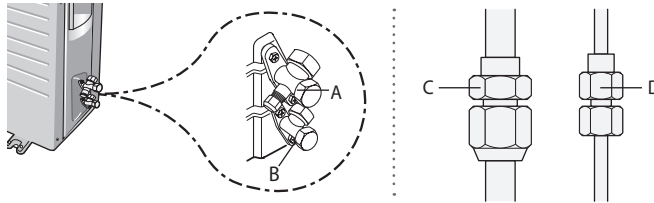

To check for gas leaks on the outdoor unit,

Check the valve A and B using a leak detector.

To check for gas leaks on the indoor unit,

Check the flare nut C and D using a leak detector.

Leak test with nitrogen (before opening valves)

In order to detect basic refrigerant leaks, before recreating the vacuum and recirculating the R410A, it's responsible of installer to pressurize the whole system with nitrogen (using a cylinder with pressure reducer) at a pressure above 40 bar (gauge).

Leak test with R410A (after opening valves)

Before opening valves, discharge all the nitrogen from the system and create vacuum according to page 35~37. After opening valves, check leaks using a leak detector for refrigerant.

Pump down (before disconnecting the refrigerant connections for unit repair, removal or disposal)

Pump-down is an operation intended to collect all the system refrigerant in the outdoor unit.

This operation must be carried out before disconnecting the refrigerant tubing in order to avoid refrigerant loss to the atmosphere.

- ▶ Shut off the liquid valve with the Allen wrench.
- ▶ Turn the system on in cooling with fan operating at high velocity.
(Compressor will immediately start, provided 3 minutes have elapsed since the last stop).
- ▶ After 2 minutes of operation, shut the suction valve with the same wrench.
- ▶ Turn the system off and switch mains supply off.
- ▶ Disconnect tubing. After disconnection, protect valves and tubing ends from dust.
- ▶ Compressor damage may occur if run at a negative suction pressure.





Fixing the indoor unit in place

Perform the following work on the area where gas leak test was done priorly.

After checking for gas leaks in the system, insulate the pipe, hose and cables. Then place the indoor unit on the installation plate.

1. To avoid condensation problems, wrap foam insulation (as shown in the figure) on a part without insulation on the end of the pipes.
2. Wind the pipe, assembly cable and drain hose with vinyl tape.
3. Place the bundle (the pipe, assembly cable and drain hose) in the lower part of the indoor unit carefully so it does not project from the rear of the indoor unit.
4. Hook the indoor unit to the installation plate and move the unit to the right and left until it is securely in place.



- Make sure pipe does not move when you install the indoor unit on an installation plate.

5. Wrap the rest of the pipe with vinyl tape.
6. Attach the pipe to the wall using clamps (optional).

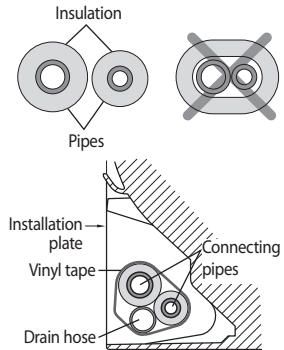

Fixing the outdoor unit in place

Install the outdoor unit in level on a stable base to avoid the generation of noise and vibration, especially when installing the unit close to a neighbor.

If you install the outdoor unit in a place exposed to strong winds or at a height, fix it to an appropriate support (wall or ground).

1. Place the outdoor unit as indicated on the top of the unit to let the discharged air out properly.
2. Fix the outdoor unit in level to an appropriate support using anchor bolts.
3. If the outdoor unit is exposed to strong winds, install shield plates around the outdoor unit so that the fan can operate correctly.

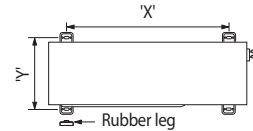

Model	X	Y
09/12/18	2.01ft (612mm)	1.04ft (317mm)
24	2.16ft (660mm)	1.12ft (340mm)
36	2.26ft (690mm)	1.32ft (403mm)



- Secure the rubber leg to prevent the generation of noise and vibration.

Outdoor unit installed on the wall by rack

- Ensure the wall will be able to suspend the weight of rack and outdoor unit;
- Install the rack close to the column as much as possible;
- Install proper grommet in order to reduce noise and residual vibration transferred by outdoor unit towards wall.

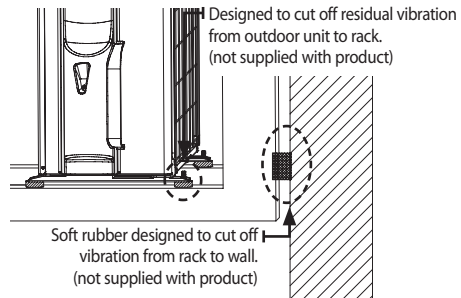



Final Check and Trial Operation

To complete the installation, perform the following checks and tests to ensure that the air conditioner operates correctly.

Check the followings:

- Strength of the installation site
- Tightness of pipe connection to detect gas leak
- Electric wiring connection
- Heat-resistant insulation of the pipe
- Drainage
- Grounding conductor connection
- Correct operation (follow the steps below)

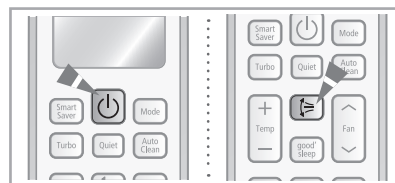

1. Press the **Power** button and check the following:

- ▶ The indicator on the indoor unit lights up.
- ▶ The airflow blade opens and the fan gears up for operation.

2. Press the **Mode** button to select Cool or Heat mode.

- ▶ In Cool mode, use **Temp +** or **-** button and set the temperature at 61°F (16°C).
- ▶ In Heat mode, use **Temp +** or **-** button and set the temperature at 86°F(30°C).



NOTE

- Approximately 3~5 minutes later, outdoor unit will start to operate and the Cool or Warm air will blow out.
- After 12 minutes of stationary condition check the indoor unit air treatment:

Cooling mode (indoor unit check) → Inlet air temp. - Outlet air temp. : From 10°K to 12°K (indicative delta T)

Heating mode (indoor unit check) → Outlet air temp. - Inlet air temp. : From 11°K to 14°K (indicative delta T)

In heating mode, the indoor fan motor can remain off to avoid cold air blown into conditioned space.

3. Press the **Air swing** button and check the following:

- ▶ The airflow blades work properly.

4. Press the **Power** button to stop the operation.



NOTE

- When you complete the installation successfully, hand over this manual to the user for storage in a handy and safe place.

Pump down procedure (when removing the product)

1. Turn on the air conditioner and select Cool mode to run the compressor for 3 minutes.
2. Release the valve caps on High and Low pressure side.
3. Use L wrench to close the valve on the high pressure side.
4. Approximately 2 minutes after, close the valve on the low pressure side.
5. Stop operation of the air conditioner.
6. Disconnect the pipes.









How to connect your extended power cables

Items to prepare

(compressor and insulation tape should be prepared by an installation technician.)

Tools	Crimping plier	Connection sleeve	Insulation tape	Contraction tube (mm)
Spec	MH-14	0.79xØ0.28inch ((20xØ7.0mm)(HxOD)	Width 0.71inch(18mm)	1.97x Ø0.31inch (50xØ8.0mm)(LxOD)
Shape				

- As shown in the figure, peel off the shields from the rubber/wire of the power cable.
- Peel off 0.79inch(20mm) of the wire shields of the tube installed already.



• After peeling off the tube wire, you must insert a contraction tube.

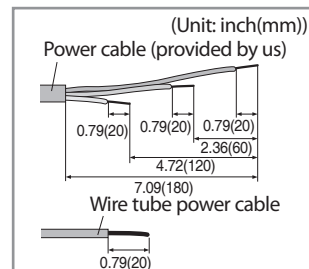

- Insert both sides of core wire of the power cable into the connection sleeve.

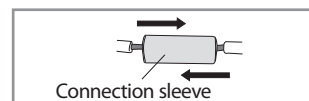

- Using a compressor, compress the two points and flip it over and compress another two points in the same location.
- The compression dimension should be 8.0.
- After compressing it, pull both sides of the wire to make sure it is firmly pressed.

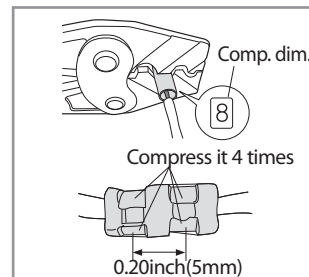

- Wrap it with the insulation tape twice and position your contraction tube in the middle of the insulation tape.

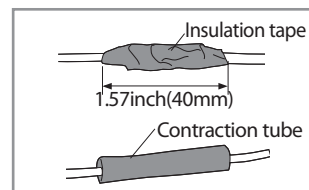

- Apply heat to the contraction tube to contract it.

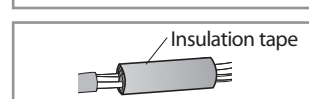

- After tube contraction work is completed, wrap it with the insulation tape to finish.



• In case of extending the electric wire, please DO NOT use a round-shaped pressing socket.
- Incomplete wire connections can cause electric shock or a fire.

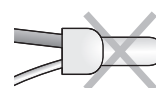



Sub PCB installation(optional)

(Wired remote controller, central remote controller etc.)

1. Turn the power off and tightly grab top of the front panel and pull it down to open. Then slightly lift the panel up.
2. Take off the Cover PCB, remove the Flocked.
3. Attach the Sub PCB to the right side of the Panel-frame.

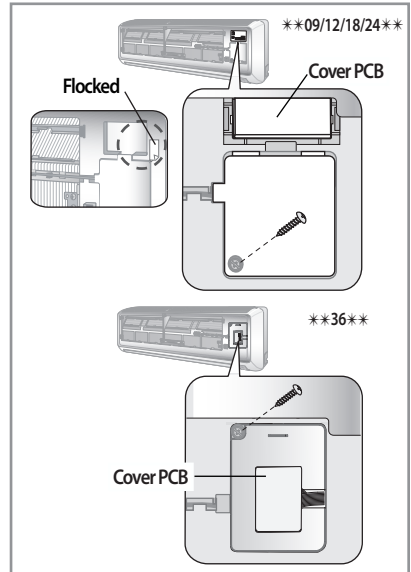
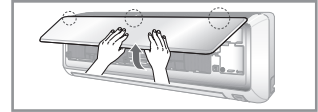

4. Find the PCB wire, and connect the wire to the Sub PCB as seen in the picture.
5. Connect the wire(remote controller, central remote controller etc) to the Sub PCB.

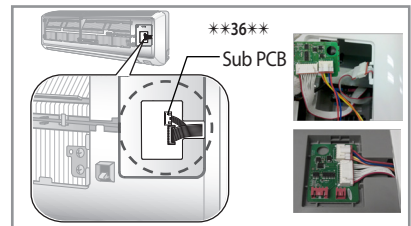
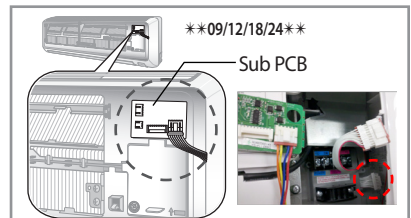

6. Assemble the Cover PCB and the front panel.





• The Sub PCB is attached to be controlled by the wired remote controller and central controller.



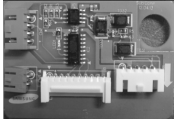

Remocon module installation (optional)

Components parts

Product name	RAC-SUB PBA	Haness Wire(for Wired Remocon)		Wire Joint	
Quantity	1EA		1EA		4EA
Shape					
Code	DB93-13561A		DB93-11405A		DB96-90020A

Description

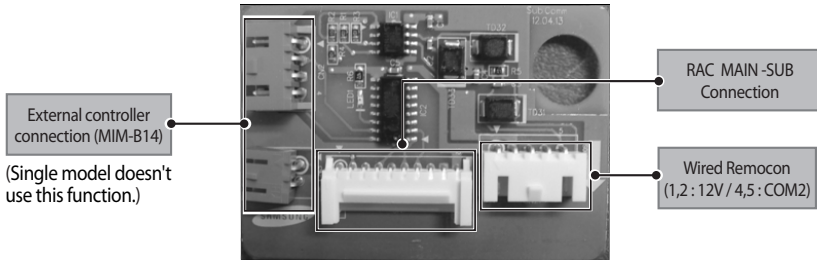

RAC SUB PBA - Wired Remote Controller Wire Connection

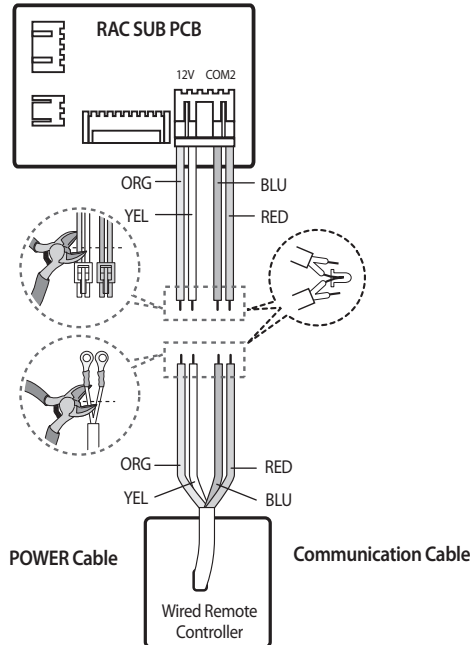



QUESTIONS OR COMMENTS?

COUNTRY	CALL	OR VISIT US ONLINE AT
CANADA	1-800-SAMSUNG(726-7864)	www.samsung.com/ca www.samsung.com/ca_fr (French)
MEXICO	01-800-SAMSUNG(726-7864)	www.samsung.com
U.S.A	1-800-SAMSUNG(726-7864)	www.samsung.com
ARGENTINE	0800-333-3733	www.samsung.com
BRAZIL	0800-124-421 4004-0000	www.samsung.com
CHILE	800-SAMSUNG(726-7864) From mobile 02-482 82 00	www.samsung.com
Bolivia	800-10-7260	www.samsung.com
COLOMBIA	01-8000112112	www.samsung.com
COSTA RICA	0-800-507-7267	www.samsung.com
DOMINICA	1-800-751-2676	www.samsung.com
ECUADOR	1-800-10-7267	www.samsung.com
EL SALVADOR	800-6225	www.samsung.com
GUATEMALA	1-800-299-0013	www.samsung.com
HONDURAS	800-27919267	www.samsung.com
JAMAICA	1-800-234-7267	www.samsung.com
NICARAGUA	00-1800-5077267	www.samsung.com
PANAMA	800-7267	www.samsung.com
PERU	0-800-777-08	www.samsung.com
PUERTO RICO	1-800-682-3180	www.samsung.com
TRINIDAD & TOBAGO	1-800-SAMSUNG(726-7864)	www.samsung.com
VENEZUELA	0-800-100-5303	www.samsung.com





AQ*09VFU* Series
AQ*12VFU* Series
AQ*18VFU* Series
AQ*24VFU* Series
AQ*36VFU* Series

Air Conditioner user & installation manual

**Planet
First** 100%
Recycled Paper

This manual is made with 100% recycled paper.



INVERTER

imagine the possibilities

Thank you for purchasing this Samsung product.
To receive more complete service, please
register your product at

www.samsung.com/register

© S F DB98-32163A-2

SAMSUNG

