

**Installation and Programming
Instructions for**

Robertshaw®

Deluxe Programmable Thermostats

TABLE OF CONTENTS

INTRODUCTION.....	4
STANDARD FEATURES	4-6
THERMOSTAT LOCATION	7
REMOVING THE THERMOSTAT FROM THE SUBBASE.....	8
DESCRIPTION OF THE DIP SWITCH FUNCTIONS.....	9-11
COVER LOCK	12
REPLACING THE THERMOSTAT ON THE SUBBASE.....	12
WIRING DIAGRAMS	13-24
PROGRAMMING 7 DAY MODELS	26-29
PLANNING YOUR SCHEDULE.....	25
SETTING THE CURRENT DAY AND TIME	26
SETTING YOUR PROGRAM TEMPERATURES	26
SETTING YOUR PROGRAM TIMES.....	27
TEMPERATURE OVERRIDE.....	28
CHANGING FAHRENHEIT (°F) TO CELSIUS (°C).....	29
CHANGING 12 HOUR TIME TO 24 HOUR TIME.....	29

POWER FAILURES	29
OUTDOOR TEMPERATURE INDICATOR (OPTIONAL).....	29
PROGRAMMING 5/2 DAY MODELS	30-34
TYPICAL RESIDENTIAL SCHEDULE.....	30
PLANNING YOUR SCHEDULE.....	31
SETTING THE CURRENT DAY AND TIME	32
SETTING THE WEEKDAY PROGRAM TIMES AND HEATING TEMPERATURES	32-33
SETTING THE WEEKEND PROGRAM TIMES AND HEATING TEMPERATURES	33
SETTING THE WEEKDAY AND WEEKEND COOLING TEMPERATURES	33-34
REVIEWING SCHEDULED TIMES AND TEMPERATURES	35
CHANGING SCHEDULED TIMES AND TEMPERATURES	35
SPECIFICATIONS	36-37
IMPORTANT INSTALLER'S NOTE	38-39

IMPORTANT: Read this manual thoroughly to understand all the features of your deluxe programmable thermostat.

INTRODUCTION

The Deluxe Programmable Thermostat represents the most advanced solid-state, microcomputer temperature control on the market today. The thermostat incorporates state-of-the-art technology packaged in an extremely low profile designer series case. Ultra-Touch controls are combined with an easy-to-read, full function liquid crystal display to provide the ultimate in user friendly operation of your heating and air conditioning equipment.

STANDARD FEATURES

- No batteries required – always remembers scheduled events and temperatures
- 100% solid state circuitry
- Computerized heat anticipation and cooling droop
- Built-in short cycle protection during normal operation
- Tamper proof electronic keyboard lockout
- Auto or manual fan operation
- Auto or manual heat/cool changeover*
- Constant hold feature allows continuous override
- Temporary temperature override
- Selectable 12 or 24 hour clock display
- Selectable Fahrenheit or Celsius temperature display
- Lockable access cover
- Full function liquid crystal display (LCD)

*No Auto Changeover on 300-204, 205, 206, or 230

FOR MODELS 300-224, 226, 230

Press to set the real time day, hour and minute

Press to change from Standard Time to Daylight Saving Time

Press to set program temperatures and start times

Press to hold the current setting. The program will hold indefinitely or until RESUME is pressed

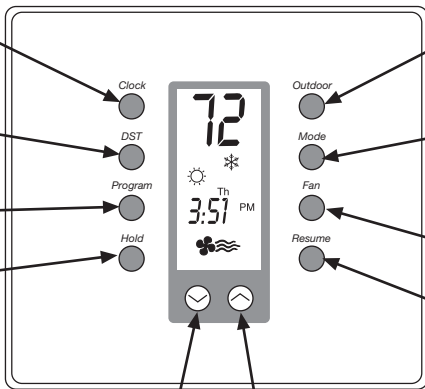

Press to display the outdoor temperature (optional)

Press to select heat/cool/auto/off. The word is displayed for 5 seconds. (Emergency heat for 300-226)

Select for continuous fan or auto fan

Press to exit the hold or override program, or when programming is complete

To lower the setpoint

To raise the setpoint

Press and at the same time to change

FOR MODELS 300-225, 227, 229

Press to set the real time day, hour and minute

Press to set the heating and cooling setpoints

Press to set program days and times

Press to hold the current setting. The program will hold indefinitely or until RESUME is pressed

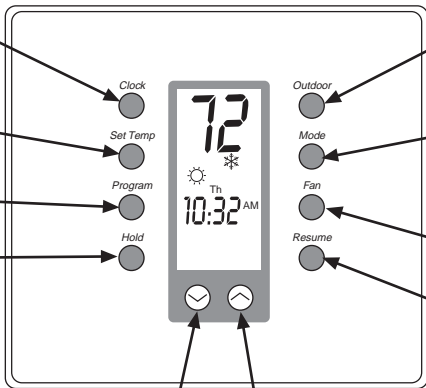

Press to display the outdoor temperature (Optional)

Press to select heat/cool/auto/off.

The word is displayed for 5 seconds. (Emergency heat for 300-227)

Select for continuous fan or auto fan

Press to exit the hold or override program, or when programming is complete

To lower the setpoint

To raise the setpoint

Press and at the same time to change

THERMOSTAT LOCATION

To ensure proper operation, the thermostat should be mounted on an inside wall in a frequently occupied area of the building. In addition, its position must be at least 18" (46 cm) from any outside wall, and approximately 5', (1.5 m) above the floor in a location with freely circulating air of an average temperature.

Be sure to avoid the following locations:

- behind doors or in corners where freely circulating air is unavailable
- where direct sunlight or radiant heat from appliances might affect control operation
- on an outside wall
- adjacent to, or in line with, conditioned air discharge grilles, stairwells or outside doors
- where its operation may be affected by steam or water pipes or warm air stacks in an adjacent partition, or by an unheated/uncooled area behind the thermostat
- where its operation will be affected by the supply air of an adjacent unit
- near sources of electrical interference such as arcing relay contact

REMOVING THE THERMOSTAT FROM THE SUBBASE

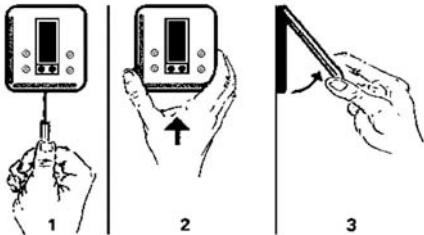

1. Insert a flat blade screwdriver or coin 1/8" into the slot located in the bottom center of the thermostat case and twist 1/4 turn. When you feel or hear a click, grasp the case from the bottom two corners and separate from the subbase as shown in the diagram at the left. *Some models require more force than others when separating due to the number of terminals used.*
 2. Swing the thermostat out from the bottom.
 3. Lift the thermostat up and off the subbase.
4. Place the rectangular opening in the subbase over the equipment control wires protruding from the wall and, using the subbase as a template, mark the location of the two mounting holes (exact vertical mounting is necessary only for appearance).
 5. Use the supplied anchors and screws for mounting on drywall or plaster; drill two 3/16" (5mm) diameter holes at the marked locations; use a hammer to tap the nylon anchors in flush to the wall surface and fasten subbase using the supplied screws. (Do not over tighten!)
 6. Connect the wires from your system to the thermostat terminals as shown in the wiring diagrams. Carefully dress the wires so that any excess is pushed back into the wall cavity or junction box. Ensure that the wires are flush to the plastic subbase. The access hole should be sealed or stuffed to prevent drafts from affecting the thermostat.

DESCRIPTION OF THE DIP SWITCH FUNCTIONS

2 Events or 4 Events Per Day (300-225, 300-227, 300-229)

Your thermostat can be set to either 2 events or 4 events per day.

2 events will allow you to program a Day ☀ setting and a Night ☾ setting.

4 events will allow you to program Morning 🌅 , Day ☀ , Evening 🌆 and Night ☾ settings.

Smart Fan (300-225, 300-227, 300-229)

When the Smart Fan switch is in the ON position and the fan 🌀 has been energized (during the occupied program), the thermostat will keep the fan running continuously during the occupied programs and automatically cycle the fan with a call for heating or cooling during the unoccupied program. **NOTE:** The unoccupied program is the Night program.

2 Minute or 4 Minute Minimum On Times

Keypad Lock

Place the switch in the locked position to lockout all buttons except the OUTDOOR button.

Plenum Fan Switch (300-224, 300-225, 300-229)

OFF – Fan comes on immediately with heat (used on electric heat).

ON – Fan is controlled by the system (used on gas/oil heat).

Standard/Add-on Heat Pump (300-226, 300-227)

For most heat pump applications, this switch should be left in the standard position. This will allow the compressor and the auxiliary heat to be on simultaneously. For add-on heat pumps, or heat pumps that require fossil fuel kits, move this switch to the add-on position. This will turn off the compressor with a call for auxiliary heat.

Single or Multistate (300-227, 300-229)

For equipment with a single compressor (2 heat/1 cool for 300-227 or 1 heat/1 cool for 300-229), switch to single stage. For equipment with two compressors (3 heat/2 cool for 330-227 or 2 heat/2 cool for 300-229), switch to multistage.

LED #1 (300-226, 300-227, 300-229)

Switch ON will energize the LED light pipe at the top of the thermostat plus the filter indicator on the display. This indicates the filter needs to be changed.

LED #2 (300-226, 300-227, 300-229)

Switch ON will energize the LED light pipe at the top of the thermostat plus the wrench indicator on the display. This indicates service is required.

FEATURES

Remote Sensor RS1 – RS2 – RS+V

The thermostat is designed to accept the remote sensor (10-528) which will allow you to locate your thermostat in an area away from view.

LED Auxiliary Heat Indicator (300-226, 300-227)

Your thermostat is equipped with an LED that indicates when the system has engaged auxiliary heat mode. It is the center (red) LED.

Add-On Heat Pumps (300-226, 300-227)

Your thermostat is equipped to enhance the performance of an add-on heat pump. In most applications, the thermostat will perform the function of a fossil fuel kit.

To select Add-On, place switch (**#3 for 300-226, #5 for 300-227**) to the ON position. The thermostat will turn off the compressor with a call for AUX heat. When the switch is set to normal, the thermostat allows the compressor and the AUX heat to be on simultaneously.

Setting the Outdoor High and Low Temperature Balance Points (300-226, 300-227)

When using the optional Robertshaw remote outdoor sensor (Uni-Line #10-529), you can select the outdoor balance points to lock-out the auxiliary heat and/or the compressor of the heat pump.

To set the balance points:

1. Press and hold the OUTDOOR button, then press the MODE button. **HibP** will appear in the display meaning high balance point, along with the factory setting of 119°F (48°C). Any outside temperature above the **HibP** will lock out the auxiliary heat, any temperature below the **HibP** will allow the auxiliary heat to run when called for by the thermostat.
2. Press the **s** or **t** buttons to set the **HibP** temperature. (A typical setting may be 52°F.)
3. Press the OUTDOOR button. **LobP** will appear in the display meaning low balance point, along with the factory setting of -54°F (-48°C). Any outside temperature below the **LobP** will lock out the compressor, any temperature above the **LobP** will allow the compressor to run when called for by the thermostat.
4. Press the **s** or **t** buttons to set the **LobP** temperature. (A typical setting may be 28°F.)
5. Press the RESUME button.

COVER LOCK

You also may lock the cover down to prevent unauthorized access to the thermostat by adding the clear plastic lock (included in the installation bag). To install, remove the thermostat from the subbase and place the clear plastic lock in the subbase as shown below. Replace the thermostat and close the cover. The cover now is locked. To open, simply use a screwdriver to push the lock back, allowing the cover to open. To remove the lock, open the cover, remove the thermostat from the subbase, then remove the lock.

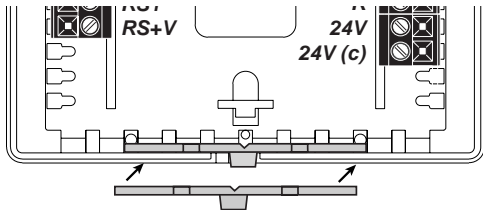

REPLACING THE THERMOSTAT ON THE SUBBASE

1. Position the thermostat on the hinged tabs located at the top of the subbase.
2. Gently swing the thermostat down and press on the bottom center edge until it snaps in place.

WIRING DIAGRAM – 300-224

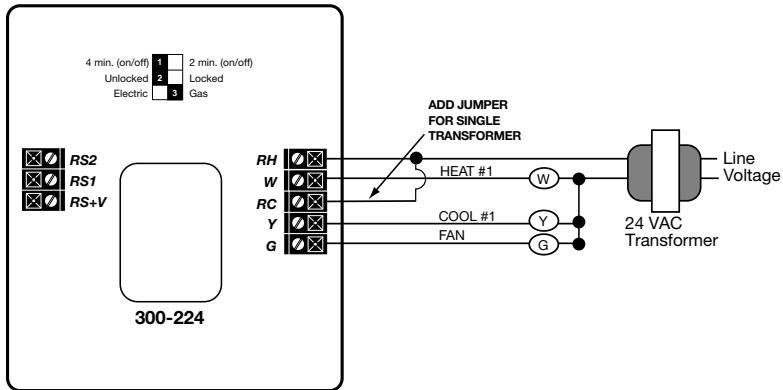

OUTPUT TERMINAL FUNCTIONS – 300-224

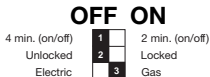
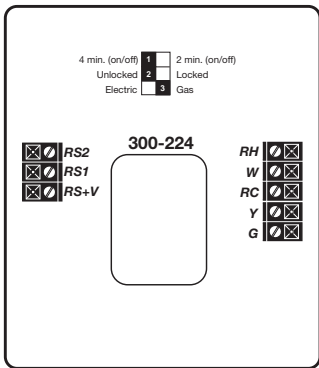

- RH24VAC supply from heating
- WEnergizes the heating equipment with a call for heating
- RC24VAC supply from cooling
- YEnergizes the cooling equipment with a call for cooling
- G.....Fan is energized with a call for heating or cooling or selected by pressing the FAN button in heating mode.
- RS2.....Use to connect outdoor temperature sensor and/or
- RS1
- RS+V indoor remote sensor options. Refer to the instructions included with the sensors.

Equipment load resistors (provided) may be required on the W, Y and G switching circuits if the equipment loads do not draw .080 amps.

Connect load resistors at the equipment.

*See important installer's note on pages 38 and 39.

WIRING DIAGRAM – 300-225

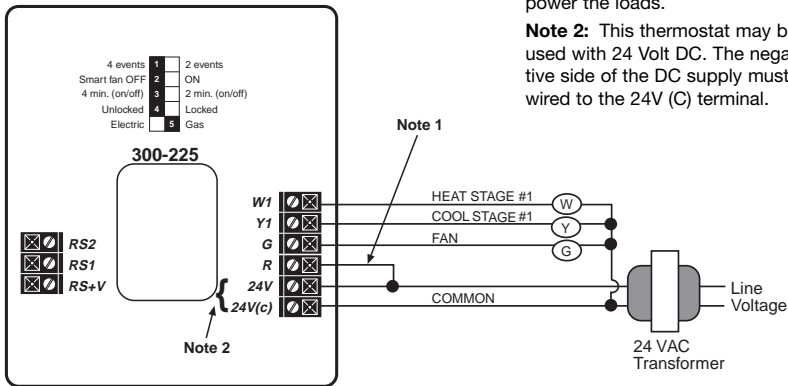

OUTPUT TERMINAL FUNCTIONS – 300-225

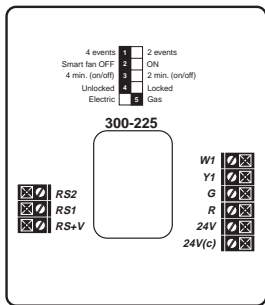

W1Energizes on a call for first stage heat

Y1Energizes with a call for cooling

G.....Fan is energized with a call for heating or selected by pressing the FAN button

R.....Independent switching voltage*

24V24 VAC hot from the equipment transformer

24V(c)24 VAC common from the equipment transformer

RS2.....Use to connect outdoor temperature

RS1 sensor and/or indoor remote sensor

RS+V options. Refer to the instructions included with the sensors.

* Allows for DC operation required on some older Lennox and McQuay units.

To replace a dual transformer system, connect the hot lead of the higher rated transformer (T1) to the 24V terminal. Connect the common to the 24V(C). Connect the common of the second transformer to the common lead of the T1 and tape off or wire nut the hot lead of T2.

OFF ON

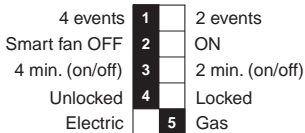

WIRING DIAGRAM – 300-226

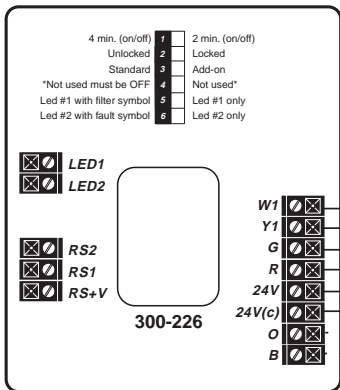

Note 1: If jumper is removed, the R terminal may be used to accommodate independent switching circuits.

Note 2: This thermostat may be used with 24 Volt DC. The negative side of the DC supply must be wired to the 24V (C) terminal.

Remove connection if separate transformer used

*** Important: Switch #4 must be left in OFF position**

OUTPUT TERMINAL FUNCTIONS – 300-226

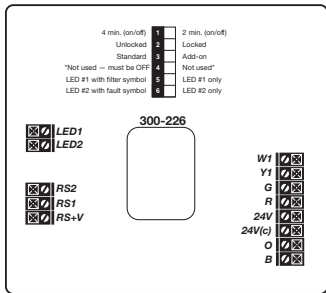

OFF ON

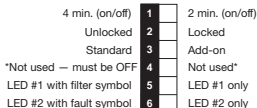

- W1**Auxiliary heat is energized as second stage heating or emergency heat
- Y1**Compressor is energized with a call for heating or cooling
- G**Fan is energized with a call for heating or cooling or selected by pressing the FAN button
- R**Independent Switching Voltage**
- 24V**24 VAC hot from the equipment transformer
- 24V(c)**.....24 VAC common from the equipment transformer
- LED 1**Free lights for status or function indication
- LED 2**
- RS2**Use to connect outdoor temperature sensor and/or indoor remote sensor options. Refer to the instructions included with the sensors.
- RS1**
- RS+V**
- O**Energizes the reversing continuously in the cooling mode.
- B**Energizes the reversing continuously in the heating and off modes.

** Allows for DC operation required on some older Lennox and McQuay units.

*** Important: Switch #4 must be left in OFF position**

WIRING DIAGRAM – 300-227

Note 1: If jumper is removed, a separate transformer must be used to power the loads.

Note 2: This thermostat may be used with 24 Volt DC. The negative side of the DC supply must be be wired to the 24V (c) terminal.

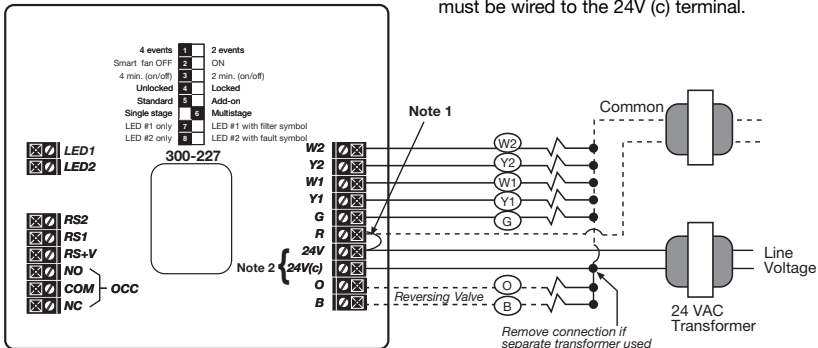

OUTPUT TERMINAL FUNCTIONS – 300-227

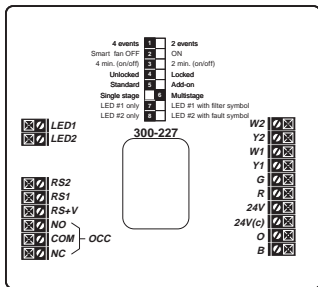

OFF ON

4 events	1	2 events
Smart fan OFF	2	ON
4 min. (on/off)	3	2 min. (on/off)
Unlocked	4	Locked
Standard	5	Add-on
Single stage	6	Multistage
LED #1 only	7	LED #1 with filter symbol
LED #2 only	8	LED #2 with fault symbol

- W2**.....Energizes auxiliary heat as second stage emergency heat
Y2.....Energizes compressor #2 on a call for second stage heating or cooling
W1.....Energizes auxiliary heat as last stage heating or first stage emergency heat
Y1.....Energizes compressor #1 on a call for first stage heating or cooling
G.....Fan is energized with a call for heating or cooling or by pressing the FAN button
R.....Independent switching voltage*
24V.....24 VAC hot from the equipment transformer
24V(c).....24 VAC common from the equipment transformer
LED1.....Free lights for status
LED2..... or function indication
RS2.....Use to connect outdoor temperature sensor
RS1.....and/or indoor remote sensor options. Refer to the instructions included with the sensors.
RS+V.....to the instructions included with the sensors.
O.....Energizes the reversing continuously in the cooling mode
B.....Energizes the reversing continuously in the heating and off modes
NO.....Relay coil is deenergized in the night
COM.....event. In all other events, the relay coil is energized.
NC.....energized.
 * Allows for DC operation required on some older Lennox and McQuay units.

To replace a dual transformer system, connect the hot lead of the higher rated transformer (T1) to the 24V terminal. Connect the common to the 24V(C). Connect the common of the second transformer to the common lead of the T1 and tape off or wire nut the hot lead of T2.

WIRING DIAGRAM – 300-229

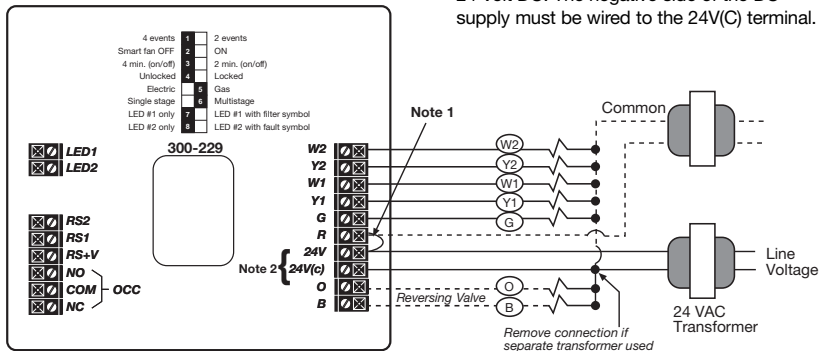

Note 1: If jumper is removed, a separate transformer must be used to power the loads.

Note 2: This thermostat may be used with 24 Volt DC. The negative side of the DC supply must be wired to the 24V(C) terminal.

OUTPUT TERMINAL FUNCTIONS – 300-229

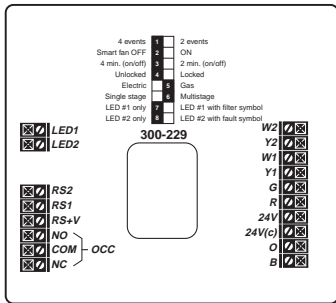

OFF ON

4 events	1	2 events
Smart fan OFF	2	ON
4 min. (on/off)	3	2 min. (on/off)
Unlocked	4	Locked
Electric	5	Gas
Single stage	6	Multistage
LED #1 only	7	LED #1 with filter symbol
LED #2 only	8	LED #2 with fault symbol

- W2**.....Energizes auxiliary heat as second stage emergency heat
- Y2**.....Energizes compressor #2 on a call for second stage heating or cooling
- W1**.....Energizes auxiliary heat as last stage heating or first stage emergency heat
- Y1**.....Energizes compressor #1 on a call for first stage heating or cooling
- G**.....Fan is energized with a call for heating or cooling or by pressing the FAN button
- R**.....Independent switching voltage*
- 24V**.....24 VAC hot from the equipment transformer
- 24V(c)**.....24 VAC common from the equipment transformer
- LED1**.....Free lights for status
- LED2**.....or function indication
- RS2**.....Use to connect outdoor temperature sensor and/or indoor remote sensor options. Refer to the instructions included with the sensors.
- RS1**.....
- RS+V**.....Energizes the reversing continuously in the cooling mode
- O**.....Energizes the reversing continuously in the heating and off modes.
- B**.....Energizes the reversing continuously in the heating and off modes.
- NO**.....Relay coil is deenergized in the night event. In all other events, the relay coil is energized.
- COM**.....
- NC**.....

* Allows for DC operation required on some older Lennox and McQuay units.

To replace a dual transformer system, connect the hot lead of the higher rated transformer (T1) to the 24V terminal. Connect the common to the 24V(C). Connect the common of the second transformer to the common lead of the T1 and tape off or wire nut the hot lead of T2.

WIRING DIAGRAM – 300-230

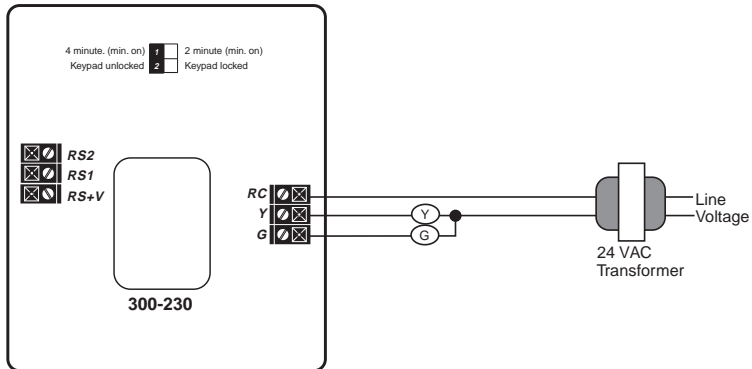

OUTPUT TERMINAL FUNCTIONS – 300-230

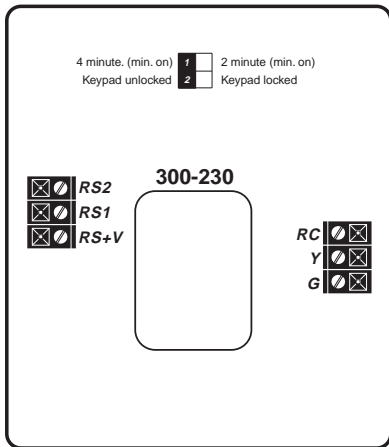

RC24VAC supply from cooling equipment transformer

YEnergizes the cooling equipment with a call for cooling

GFan is energized with a call for cooling of selected by pressing the FAN button

RS2.....Use to connect outdoor temperature sensor and/or indoor remote sensor options. Refer to the instructions included with the sensors.

Equipment load resistors (provided) may be required on the Y and G switching circuits if the equipment loads do not draw .080 amps per circuit minimum.

Connect load resistors at the equipment.

OFF ON

4 minute. (min. on) 1 2 minute (min. on)
Keypad unlocked 2 Keypad locked





PLANNING YOUR SCHEDULE (300-225, 300-227, 300-229)

Your new Robertshaw programmable thermostat has been designed so that you can select either 2 program periods (Day and Night) or 4 program periods (Morning, Day, Evening and Night). The thermostat comes from the factory set for 4 program periods. To change this setting, please refer to the “2 Events or 4 Events Per Day” section on page 8.

To help save programming time, we suggest you use the worksheet below to set-up your specific program.

Note: If you plan to use the automatic changeover mode, you cannot set your heating and cooling temperatures closer than 2 degrees apart for the same program period.

Programming Chart

PROGRAM PERIOD	MORNING 	DAY 	EVENING 	NIGHT 
Temperatures	Heat: <input type="text"/>	Heat: <input type="text"/>	Heat: <input type="text"/>	Heat: <input type="text"/>
	Cool: <input type="text"/>	Cool: <input type="text"/>	Cool: <input type="text"/>	Cool: <input type="text"/>
	(Time)	(Time)	(Time)	(Time)
Monday				
Tuesday				
Wednesday				
Thursday				
Friday				
Saturday				
Sunday				

SETTING THE CURRENT DAY AND TIME



1. Press the CLOCK Button.* The display will flash a day of the week.
2. Press the s or t buttons until the current day shows.
3. Press the CLOCK button again. The display will flash the hour. (Note the AM/PM indicator.)
4. Press the s or t buttons until the current hour shows.
5. Press the CLOCK button again. The display will flash the minutes.
6. Press the s or t buttons until the current minutes show.
7. Press the CLOCK button and the current day and time are now set.

* Note: If a button is not pushed in 15 seconds, the thermostat will automatically return to normal operation.

SETTING YOUR PROGRAM TEMPERATURES

With your specific program determined, you are ready to begin programming. You now will enter the individual program period temperatures for the heating program.



1. Press the MODE button until HEAT is displayed.
2. Press the SET TEMP button.* The first program period (Morning) will be displayed.
3. Press the s or t buttons to adjust that program period's temperature for heating.
4. Repeat Steps 2 and 3 for the Day, Evening and Night program periods. Remember, if your thermostat was set for two program periods, you will only have to repeat Steps 2 and 3 for the Night program period.
5. Press the MODE button until COOL is displayed. You now will enter the individual program period temperatures for the cooling program.
6. Repeat Steps 2, 3 and 4 for the cooling temperatures.
7. Press the MODE button until your desired mode of operation appears: HEAT-AUTO-OFF-COOL.
8. Press the RESUME button to return to normal operation.

* Note: If a button is not pushed in 15 seconds, the thermostat will automatically return to normal operation. You may go back into the programming portion simply by repeatedly pressing the SET TEMP button until you get back to where you left off.

SETTING YOUR PROGRAM TIMES

Referring to your Schedule Planner, you now will enter the times for the program periods.

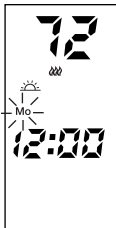

1. Press the PROGRAM button. The display will flash a day of the week.
 2. Press the **s** or **t** buttons to select the day you wish to program. (We suggest starting with Monday.)
 3. Press the PROGRAM button. The display will flash the hour of the first period (Morning). (Note the AM/PM indicator.)
 4. Press the **s** or **t** buttons to adjust the desired hour for the first program period.
 5. Press the PROGRAM button again. The display will flash the minutes.
 6. Press the **s** or **t** buttons to adjust the desired minutes for the first period. (Note the minutes are in increments of 10.)
 7. Repeat Steps 3-6 for the Day, Evening and Night periods. Remember, if your thermostat was set for two program periods, you will only have to repeat Steps 3-6 for the Night period.
 8. After entering the Night period, press the PROGRAM button. **COPY** will be displayed. The copy function will allow program times to be copied to sequential days. If you do not wish to copy the program times to another day (or block of days), proceed to Step 11.
 9. Press the **s** or **t** buttons to select the next individual day, or block of days, to copy the program times to.
 10. Press the PROGRAM button to copy the program times to the selected days of the week.
 11. Repeat Steps 1-10 for any remaining unprogrammed days of the week.
 12. When finished, you can verify that all program periods are programmed correctly by repeatedly pressing the PROGRAM button. When **COPY** appears, press the PROGRAM button to skip to the next day.
- * Note: If a button is not pushed in 15 seconds, the thermostat will automatically return to normal operation. You may go back into the programming portion simply by repeatedly pressing the PROGRAM button until you get back to where you left off.

TEMPERATURE OVERRIDE



Temporary Override (3 hours)

You may change the temperature setting temporarily at any time without affecting the program.

Press the **s** or **t** buttons. The current event temperature and mode of operation will be displayed. Press the **s** or **t** buttons again to adjust the temperature. This temperature will be maintained for three hours. To cancel, simply press the **RESUME** button.

Temporary Override with Keyboard Locked (1 hour) (300-225, 300-227, 300-229)

You may change the temperature setting temporarily at any time without affecting the program, even though they keypad is locked.

- Press the **s** or **t** buttons. The display will show the temperature for the first event. Press the **s** or **t** buttons again to adjust the temperature +/-3 degrees. This temperature will be maintained for one hour.

Continuous Override (Hold)

You also may maintain a constant temperature setting at any time without affecting the program.

1. Press and release the **MODE** button until the desired mode is displayed (**HEAT** – **AUTO** – **OFF** – **COOL**)
2. Press and release the **HOLD** button. **HOLD** will be displayed.
3. Press the **s** or **t** buttons to adjust the temperature. This temperature will be maintained indefinitely. To cancel, simply press the **RESUME** button.

Note: If the auto mode is used, press the **MODE** button, then press the **s** or **t** buttons to select a heating setpoint. Press the **MODE** button, and then press the **s** or **t** buttons to select a cooling setpoint.

CHANGING FAHRENHEIT (°F) TO CELSIUS (°C)

This thermostat is preset to display the temperature in Fahrenheit. You may change the display to Celsius. To change from one to the other, simultaneously press the **s** and **t** buttons. The display will change automatically.

CHANGING 12 HOUR TIME TO 24 HOUR TIME

This thermostat is preset to display the standard 12 hour time format. You may change the display to the 24 hour time format. To change from one to the other, press and release the **CLOCK** button, then press the **MODE** button. The display will change automatically.





POWER FAILURES

This Robertshaw thermostat will maintain the program settings during any type of power failure. If power fails, **AC** will be displayed for 30 minutes. After 30 minutes, the display will go blank. If power is restored within the first 30 minutes, the thermostat will resume normal operation. If power is restored after 30 minutes, **12:00 AM** will flash, and the thermostat will control to the night event setpoint until the clock is reset. Once the clock is reset, the thermostat will resume normal operation.

OUTDOOR TEMPERATURE INDICATOR (OPTIONAL)

If your Robertshaw thermostat has been installed with an outdoor remote sensor, you can view the outdoor temperature by simply pressing and holding the **OUTDOOR** button. The thermostat will return to normal operation automatically.

TYPICAL RESIDENTIAL SCHEDULE (300-224, 300-226, 300-230)

Temperature Settings		Weekday Time AM/PM	Weekend Time AM/PM	
MORNING		HEAT 68	6:00 AM	8:00 AM
		COOL 72		
DAY		HEAT 64	9:00 AM	8:00 AM
		COOL 85		
EVENING		HEAT 68	3:30 PM	8:00 AM
		COOL 72		
NIGHT		HEAT 62	10:30 PM	10:30 PM
		COOL 78		

The first thing to do before programming your thermostat is to determine your personal comfort levels for each day with respect to time of day and desired temperature. A typical schedule is shown above.

On weekdays, after the temperature has been lowered all night, the thermostat can be programmed to begin warming the house at 6:00 AM, if the household gets up at 7:00 AM. At 9:00 AM, after everyone has left for the day, the thermostat can be set to lower the temperature to save energy during the day. Before anyone arrives home in the afternoon, the temperature may again be increased to provide comfort for when the household returns. Finally, at bedtime, the thermostat again lowers the temperature to save energy during the night.

On Saturday and Sunday when everyone is home, the temperature comes up to 68°F at 8:00 AM and stays there all day until 10:30 PM when the temperature sets back to 62°F.





PLANNING YOUR SCHEDULE (300-224, 300-226, 300-230)

To help save programming time, we suggest you use the worksheet below to set your specific program.

We suggest you set your desired program times approximately 1 hour before the time required to reach the set temperature. Therefore, if you get up at 7:00 AM, set the morning temperature to come on at 6:00 AM.

Note: If you plan to use the automatic changeover mode, you cannot set your heating and cooling temperatures closer than 2 degrees apart for the same program period.

Programming Chart

Temperature Settings			Weekday Time AM/PM	Weekend Time AM/PM
MORNING		HEAT		
		COOL		
DAY		HEAT		
		COOL		
EVENING		HEAT		
		COOL		
NIGHT		HEAT		
		COOL		

SETTING THE CURRENT DAY AND TIME

Before you set the current day and time, set the thermostat into the proper time mode by pressing the Daylight Saving Time (DST) button. If the thermostat has been installed during Daylight Saving Time, press and release the DST button until the clock symbol in the lower right corner of the display appears. If the thermostat has been installed during Standard Time, press the DST button until the clock symbol disappears.



1. Press the CLOCK button.* The display will flash a day of the week.
2. Press the s or t buttons until the current day shows.
3. Press the CLOCK button again. The display will flash the hour.
(Note the AM/PM indicator).
4. Press the s or t buttons until the current hour shows.
5. Press the CLOCK button again. The display will flash the minutes.
6. Press the s or t buttons until the current minutes show.
7. Press the CLOCK button and the current day and time are set.

*Note: If a button is not pushed in 15 seconds, the thermostat will automatically return to normal operation.

SETTING THE WEEKDAY PROGRAM TIMES AND HEATING TEMPERATURES

With your specific program determined, you are ready to begin programming. Now you will enter the times and temperatures for the weekday program period. Refer to your schedule planner for the appropriate times and heating temperature.



1. Press the MODE button until **HEAT** is displayed.
2. Press the PROGRAM button. **MO TU WE TH FR** will be displayed along with the morning symbol. The starting time will flash.
3. Press the s or t buttons to adjust the desired morning start time.
(Note AM/PM indicators.)
4. Press the PROGRAM button. The display will flash the minutes.

5. Press the **s** or **t** button to adjust the minutes. (Note the minutes are in increments of 10.)
6. Press the **PROGRAM** button. The heating temperature will be displayed.
7. Press the **s** or **t** button to adjust to the desired heating temperature.
8. Repeat Steps 2 – 7 for the Day, Evening, and Night program periods. If you wish to use only the Morning and Night program periods, skip by holding the **PROGRAM** button in the hour or minute setting and press the **MODE** button; 4 dashes will appear.



SETTING THE WEEKEND PROGRAM TIMES AND HEATING TEMPERATURES

1. After the weekday Night heating temperature has been entered, press the **PROGRAM** button. **SAT SUN** will be displayed.
2. Repeat Steps 2 – 7.
3. After weekend Night heating temperature has been entered press the **RESUME** button. (Note if the **RESUME** button is not pressed, the thermostat will automatically start the program within 15 seconds.)

SETTING THE WEEKDAY AND WEEKEND COOLING TEMPERATURES

* Note: Since the programmed schedules are the same for both heating and cooling, you only need to set the cooling temperatures providing you have already programmed the weekday and weekend heating schedules.

1. Press the **MODE** button until **COOL** is displayed.
2. Press the **PROGRAM** button. **MO TU WE TH FR** will be displayed along with the morning symbol. The starting time will flash.
3. Press the **PROGRAM** button until the cooling temperature flashes.

IMPORTANT NOTE: The cooling temperature must be set at least two degrees higher than the heating temperature.





(Example: If you set the cooling temperature less than two degrees above the heating temperature, the thermostat will automatically maintain a two degree separation between heating and cooling by lowering the heating temperature.

4. Press the **s** or **t** button to adjust to the desired cooling temperature.
5. Press the **PROGRAM** button until the day symbol is displayed and the cooling temperature flashes.
6. Press the **s** or **t** button to adjust to the desired temperature.
7. Press the **PROGRAM** button until the evening symbol is displayed and the cooling temperature flashes.
8. Press the **s** or **t** button to adjust the desired temperature.
9. Press the **PROGRAM** button until the night symbol is displayed and the cooling temperature flashes.
10. Press the **s** or **t** button to adjust to the desired temperature.
11. Press the **RESUME** button.

REVIEWING SCHEDULED TIMES AND TEMPERATURES

To review your programmed schedules, repeatedly press and release the PROGRAM button. Each scheduled event will be displayed starting with the weekday start times and temperatures and ending with the weekend start times and temperatures. To cancel your review, simply press and release the RESUME button or wait 15 seconds for the thermostat to resume automatically.

CHANGING SCHEDULED TIMES AND TEMPERATURES

To change any scheduled start time or temperature, press and release the PROGRAM button until proper symbol flashes, (e.g., day, hour, minute, or temperature) then use the s or t button to make the change. Press and release the RESUME button after all schedule changes have been made or wait 15 seconds for the thermostat to resume automatically.

SPECIFICATIONS (300-224, 300-230)

Rated Voltage	20-30 VAC, 24 nominal
Rated A.C. Current08 Amps to 1.5 Amps continuous per output with surges to 4 Amps Max.
Control Range	Heating: 38° to 88°F in 1° Steps 5° to 30°C in 1° Steps Cooling: 60° to 108°F in 1° Steps 16° to 40°C in 1° Steps
Thermostat Measurement Range.....	28° to 124°F or 0° to 48°C
O.D.T. Displayed Range.....	-50° to 124°F or -48° to 48°C
Control	± .5°C at 20°C ± 1°F at 68°F
Minimum Deadband	(between heating and cooling) 2°F or 1°C

NOTE: This thermostat contains electronic circuitry replacing the conventional mechanical anticipator.

SPECIFICATIONS (300-225, 300-226, 300-227, 300-229)

Rated Voltage	20-30 VAC, 24 nominal
Rated A.C. Current050 Amps to 0.75 Amps continuous per output with surges to 3 Amps Max.
Rated D.C. Current	0 Amps to 0.75 Amps continuous per output with surges to 3 Amps Max.
Control Range	Heating 38° to 88°F in 1° Steps 5° to 30°C in 1° Steps Cooling: 60° to 108°F in 1° Steps 16° to 40°C in 1° Steps
Thermostat Measurement Range.....	28° to 124°F or 0° to 48°C
O.D.T. Displayed Range.....	-50° to 124°F or -48° to 48°C
Control Accuracy	± .5°C at 20°C ± 1°F at 68°F
Minimum Deadband	(between heating and cooling) 2°F or 1°C

NOTE: This thermostat contains electronic circuitry replacing the conventional mechanical anticipator.

IMPORTANT INSTALLER'S NOTE FOR THE 300-224

This thermostat is equipped with a transformer wiring fault indicator (located along the top left side of the thermostat).

If the red light is ON when the wiring is complete, you must check the equipment to ensure that the transformers are wired in accordance with the diagrams provided on this sheet.

Note: Continued operation of the thermostat with the red light ON will damage the thermostat.

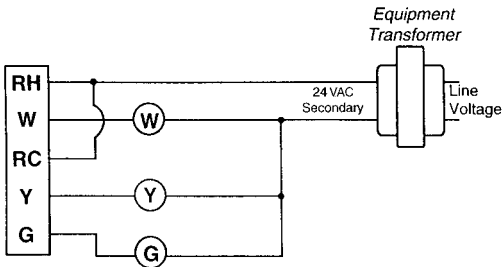

SINGLE TRANSFORMER

If the fault indicator is ON, the transformer exceeds the allowed 30 VAC.

Replace the transformer.

TWO TRANSFORMER SYSTEM

If the fault indicator is ON the transformers are out of phase. Switch the secondary wires of one of the transformers (NOT BOTH) and ensure the red light goes OFF.

Separate RH and RC Wires

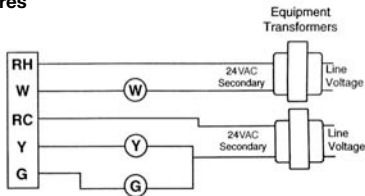

Single RH/RC Wires

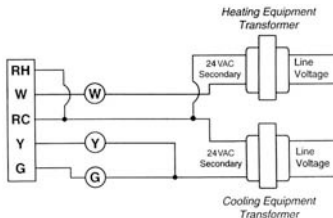

ROBERTSHAW DELUXE PROGRAMMABLE THERMOSTATS
MEET CA TITLE 24 REQUIREMENTS

Robertshaw warrants to the original purchaser that this product and its component parts will be free from defects in workmanship and materials for a period of two years from the date of purchase. Your dealer will provide free replacement of the product upon proof of purchase.

This warranty does not apply in the event of misuse, abuse or as a result of unauthorized alterations or repairs. Robertshaw will not be liable for any consequential damages including, without limitation, damages resulting from defects, loss of use or misuse.

UNI-LINE
N O R T H A M E R I C A

ROBERTSHAW CONTROLS COMPANY • UNI-LINE NORTH AMERICA • P.O. BOX 2000 • CORONA, CA 92879-1736

Printed In U.S.A. 4/00 ©2000 Robertshaw Controls Company 97255

1-898

110-809C