



SWIMMING POOL DEHUMIDIFIER OWNER'S MANUAL

INSTALLATION
OPERATION
MAINTENANCE

THIS MANUAL MUST BE READ AND UNDERSTOOD BY A QUALIFIED PERSON OR PERSONS BEFORE INSTALLATION

CONTENTS

Introduction	2
Location/Mounting	2, 3
Condensate Drain Plumbing Connection	3
Electrical Connections, Controls, Location & Mounting	4
Duct Work And Air Distribution Installation & Design	5, 6
Remote Condenser Installation, Refrigerant Piping Of Remote Condenser And Charging Instructions	7
Air Flow Balancing	8, 9
Unit Start-Up Procedure	10
Maintenance And Service Procedure	10
Pool Water Heating Dehumidifier Procedure	11
Pool Chemical Storage Procedures & Pool Water Maintenance	11
Trouble Shooting	13
Service Diagnosis	14, 15, 16
Warranty	17, 18
Start Up Requirements	19
Personnel	20

INTRODUCTION

DCA Series

Congratulations! You have purchased the finest equipment available to control damaging humidity associated with indoor pools and spa areas.

DCA dehumidifiers are precision engineered products, specifically designed to control the conditions in your indoor pool room to obtain maximum performance and energy savings.

Your DCA dehumidifier has been carefully assembled and tested at our factory by our trained personnel. Only Skilled, Trained and Qualified Personnel may install and service your DCA equipment.

DCA cannot possibly anticipate every possible circumstance that might involve a hazard. The warnings in this manual and on tags and decals affixed to the equipment are, therefore, not all-inclusive. If you use a procedure, work method or operating technique not specifically recommended by DCA, you must satisfy yourself if it is safe for you and others.

CAUTION

Serious injury, property damage and death can result from unqualified personnel installing and servicing this equipment. High pressure refrigerants and high electrical voltage are present.

IMPORTANT

Your DCA dehumidifier is one of several essential components that is necessary in your pool room for complete environmental control. The following areas must be incorporated in your pool room by you, your contractor, engineer and architect.

- HUMIDITY CONTROL
- DUCT DESIGN
- AIR DISTRIBUTION OVER EXTERIOR GLASS AND SKYLIGHTS
- VENTILATION
- BUILDING CONSTRUCTION
- POOL WATER CHEMISTRY
- ADEQUATE POOL ROOM VAPOR BARRIER
- PROPER WALL & CEILING INSULATION
- LOW "E" GLASS & SKYLIGHTS
- PROPER STORAGE OF POOL & SPA WATER CHEMICALS

A pool room dehumidifying system will not provide desired comfort and building protection unless these areas are addressed.

Important information about each of these areas are included in this manual. It is the responsibility of the owner along with the contractor, engineer and architect to ensure that careful consideration be given to all of these areas of pool room environment control.

A DCA dehumidification system can handle all of your moisture removal needs and in many cases your heating and cooling requirements.

Dehumidification is accomplished by moving room air through the dehumidifying coil, lowering the air

temperature below its dew point. Moisture will condense on this coil thus removing a large portion of the moisture from the air. The heat recovered by the above mentioned process, known as latent heat, and the electrical consumption of the compressor is delivered by the reheat condenser coil. The air leaving the evaporator coil enters the reheat condenser coil and picks up the available heat and exits the dehumidifier as warm dry air.

With the addition of an air cooled remote condenser, a majority of the room cooling can be achieved during the warm months. If the room temperature should rise above the preset condition, the system will switch from delivering warm dry air to delivering cool dry air automatically. As stated above, the DCA system will control moisture and in many cases heat and cool the pool room enclosures.

Proper installation by qualified personnel of the dehumidifying system in the total pool room environmental control system takes careful planning and is very important for achieving desired results. With a seasonally fluctuating load, supplemental heaters must be added to compensate for any heat loss that may be needed to compensate for any heat loss that may be needed to compensate for the lack of heat from dehumidification. The supplemental heat source must be sized to handle the total heating requirements.

UNPACKING & INSPECTION

All DCA Systems are completely factory tested to ensure proper operation before shipment. Check for shipping damage both internal (concealed) and external.

NOTATION MUST BE MADE ON CARRIERS FREIGHT BILL OF LADING TO INSURE PROMPT FREIGHT DAMAGE CLAIMS PROCESSING.

Claims for freight damage or shortages must be filed within 5 days of acceptance of equipment with the delivering freight carrier. All Freight Claims must be resolved with the delivering freight carrier. The factory cannot be of any help after equipment is signed for and delivered.

LOCATION AND MOUNTING

Unless authorized by DCA all units must be installed in equipment rooms and areas that do not fall below 45° F.

Considerations must be made for service access, electrical requirements, duct work and filter access on all units.

It is extremely important that, if the dehumidifier is suspended, the ceiling structure and hanging apparatus be of sufficient capability to adequately support the weight of the dehumidifier. Check dehumidifier weight to make determination. Secondary drain pan, under dehumidifier, is required and supplied by others.

NOTE:

CLEARANCE OF 18" TO 24" IS RECOMMENDED ON TOP, BOTTOM AND ALL SIDES FOR SERVICE OF COMPONENTS SUCH AS FILTERS, MOTORS, BELTS AND OTHER ELECTRICAL AND REFRIGERATION COMPONENTS.

LOCATION/MOUNTING CONTINUED

Units may be field installed by suspending from ceilings or placed on mounting platforms made of materials of sufficient strength to prevent vibrations and sound resonance.

Install sound and vibration eliminators such as anti-vibration pads, canvas duct connectors (field supplied) or other approved methods to isolate the unit from the supportive structure and ductwork. (See figure at right).

CONDENSATE DRAIN/ PLUMBING CONNECTION

Check all local codes and by-laws for approved methods of condensate water disposal. If codes permit, condensate water is returned back to the swimming pool by gravity drainage to the nearest skimmer or surge tank (if equipped) is ideal. If codes do not permit condensate water to be returned back to the swimming pool, an approved drain must be provided for proper disposal.

If codes permit, schedule 40 PVC pipe is recommended for drainage pipe. Slope the condensate drain line with a minimum of 1/4 inch per foot. A P-trap is recommended and filled with water to prevent air from entering the unit to assure proper drainage of the condensate.

A condensate pump is required (field supplied) at installations where the unit is located below the pool water surface or drain access. If a pump is used it must have sufficient pump head to overcome vertical lift and water pressure if pumped into a pressurized pipeline. When connecting to a pressurized pipeline a check valve and solenoid should be used. Do not connect the condensate drain to a pipe with negative pressure. When the dehumidifier is installed outdoors, the drain line must be heat taped and insulated to avoid freezing.

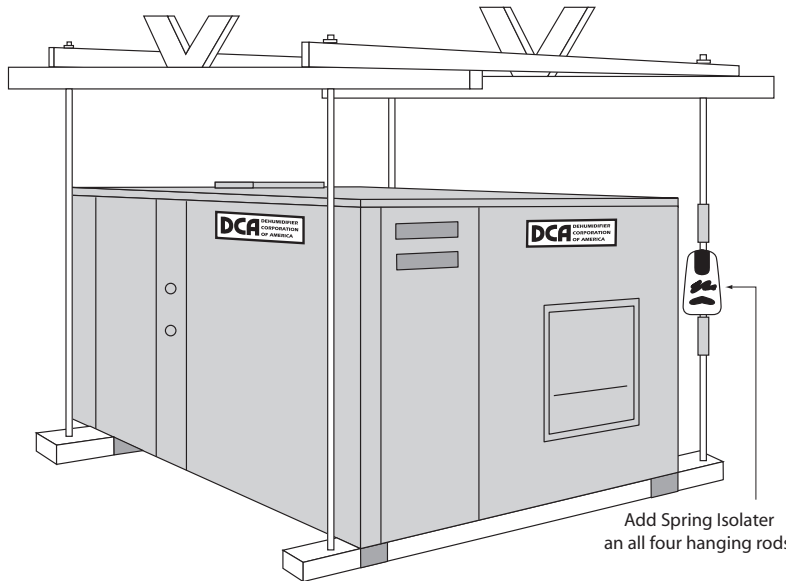

Typical Ceiling Suspended Installation

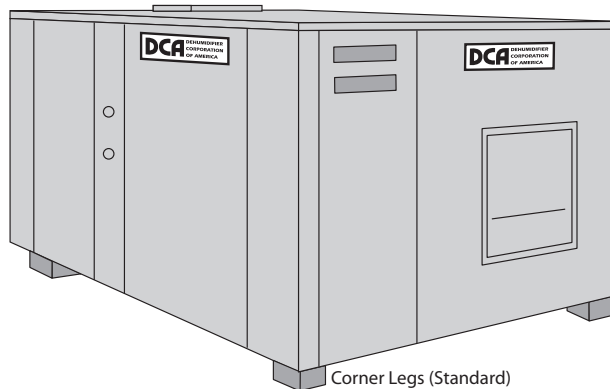

Typical Floor Installation

ELECTRICAL CONNECTIONS

The DCA unit is factory pre-wired. Field wiring is limited to power wire and the installation of wiring for 24V controls.

Provide and install a main disconnect switch within close vicinity of the dehumidifier. Refer to the unit nameplate or electrical information (Following Chart) for proper voltage, minimum ampacity and maximum main fuse protection. All wiring and main disconnect switch should be provided in accordance with all local, state and national electric codes (N.E.C.).

IMPORTANT

Make sure the DCA unit is properly grounded with correct gauge of wire via the ground lug terminal located in the control panel. Failure to properly ground unit will void all warranties. Supply voltage must not vary more than 10% of the nameplate voltage while the unit is operating.

MODEL	VOLTS	PHASE	MAXIMUM FUSE SIZE	MINIMUM AMPACITY
DCA500	208/2301		25 amp	19.2
DCA900/	208/230	1	30 amp	22.8
900WH	208/230	3	20 amp	14.2
	460V	3	10 amp	7.0
DCA1400/	208/230	1	40 amp	30.8
1400WH	208/230	3	25 amp	19.3
	460V	3	12 amp	9.6
DCA2000/	208/230	1	50 amp	35.6
2000WH	208/230	3	35 amp	25.6
	460V	3	17.5 amp	12.4
DCA2500/	208/230	1	70 amp	48.9
2500WH	208/230	3	40 amp	30.6
	460V	3	20 amp	14.6
DCA3000/	208/230	1	60 amp	43.6
3000WH	208/230	3	45 amp	32.4
	460V	3	20 amp	15.8
DCA3300/	208/230	3	60 amp	41.7
3300WH	208/230	3	30 amp	21.8
DCA3500/	208/230	1	90 amp	70.9
3500WH	460V			
DCA3800/	208/230	3	70 amp	50.6
3800WH	460V	3	35 amp	25.8
DCA4000/	208/230	1	100 amp	90.5
4000WH	460V			
DCA4200/	208/230	3	80 amp	58.6
4200WH	460V	3	40 amp	28.8
DCA5400/	208/230	3	100 amp	73.8
5400WH	460V	3	50 amp	38.8
DCA7000	208/230	3	120 amp	83.9
7000WH	460V	3	60 amp	41.5
DCA8000	208/230	3	110 amp	92.4
8000WH	460V	3	60 amp	47.1
DCA9000/	208/230	3	125 amp	108.5
9000WH	460V	3	70 amp	53.4
DCA11000	208/230	3	175 amp	154.0
	460V	3	90 amp	77.5
	575V	3	70 amp	62.7
DCA14000	208/230	3	250 amp	207.3
	460V	3	125 amp	102.4
	575V	3	110 amp	89.7

Chart A

Fuse & Ampacity Rating

The control wiring should be done according to the wiring diagram provided with the unit. The DCA control circuit operates at 24V.

CONTROLS, LOCATION & MOUNTING

Locate controls in an area of natural room air circulation usually near the return air inlet. Avoid areas of hot spots from warm air ducts, radiators or exposure to sunlight or direct room lighting. Avoid mounting controls on cold outside masonry walls, near door, windows or air conditioning outlets.

Do not locate controls in a room that is not being conditioned by the dehumidification system, unless system has remote sensors (optional).

Controls should be mounted 5 feet from floor level on an interior wall. All controls must be level.

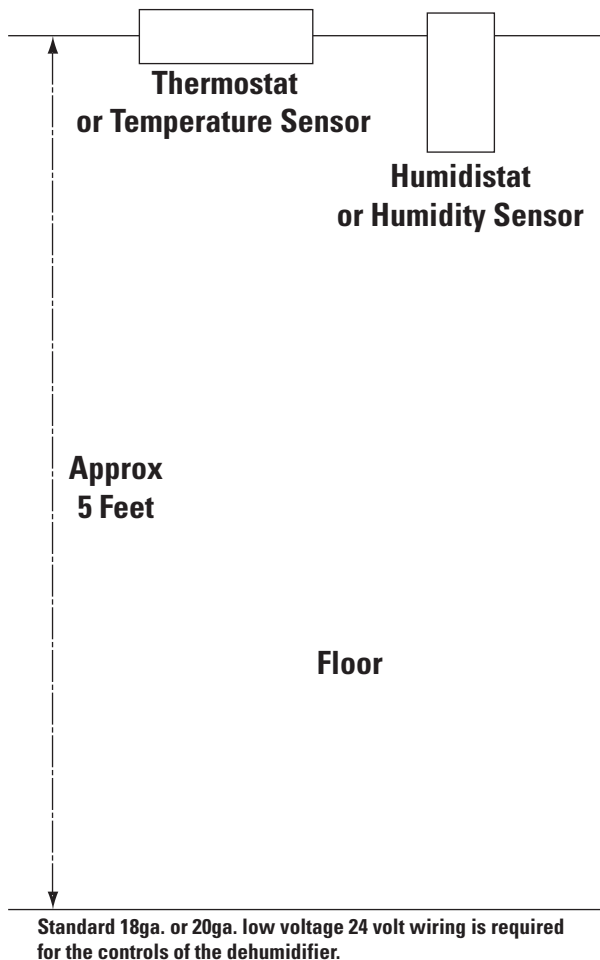

DUCT WORK AND AIR DISTRIBUTION

Proper air distribution is important in an indoor swimming pool room to prevent condensation on windows, and improve comfort. The quantity of supply air and the velocity of air from the air distribution system should be of sufficient volume to cover all areas of exterior glass, skylights and patio doors with warm, dry air. This is the only remedy to keep exterior glass and skylights from moisture and condensation build-up.

IMPORTANT

**ALL DUCT DESIGN AND CONSTRUCTION
MUST CONFORM WITH THE LATEST
ASHRAE AND SMACNA
LOW VELOCITY DUCT STANDARDS**

Refer to DCA manual for air volumes and static pressure specifications of units. Special attention should be given to the following areas to achieve desired results.

1. Supply air from registers should be directed on outside walls and away from the swimming and spa surfaces. Make sure that all outside walls and entire surface of exterior glass surfaces are covered with supply air.
2. Return air inlet should be located high in the room as possible to prevent air stratification. **Make sure that supply air does not short cycle back to the return inlet.** If dehumidifier is installed without return air duct, provide a minimum of 4 feet clearance between unit and closest obstruction.

3. The recommended duct materials are standard galvanized sheet metal, aluminum or PVC pipe. All elbows should be of low restriction. Ductwork must be insulated on the outside if located in areas that are unconditioned to prevent condensation and heat loss. Use flexible duct connectors to attach ductwork to the DCA unit to eliminate any vibrations.
4. Grilles, registers and diffusers should be selected on the basis of low noise criteria (NC) noise levels, CFM requirements as well as air diffusion patterns to cover cold surfaces with conditioned air. Choose hardware resistant to deterioration from the presence of chemicals in the pool room atmosphere. 100 CFM per register is recommended.
5. Ceiling fans can be used, local codes permitting, to insure more complete air circulation. Make sure that air is directed upward to avoid drafts that can result in increased water evaporation.

IMPORTANT

**POOR DUCT DESIGN AND INSTALLATION
WILL RESULT IN UNEVEN AIR DISTRIBUTION,
POOR OPERATING PERFORMANCE,
REDUCED MOISTURE REMOVAL, MOISTURE FORMATION
ON EXTERIOR GLASS AND SKYLIGHTS
AND INCREASED OPERATING COSTS.**

Typical Duct Installations

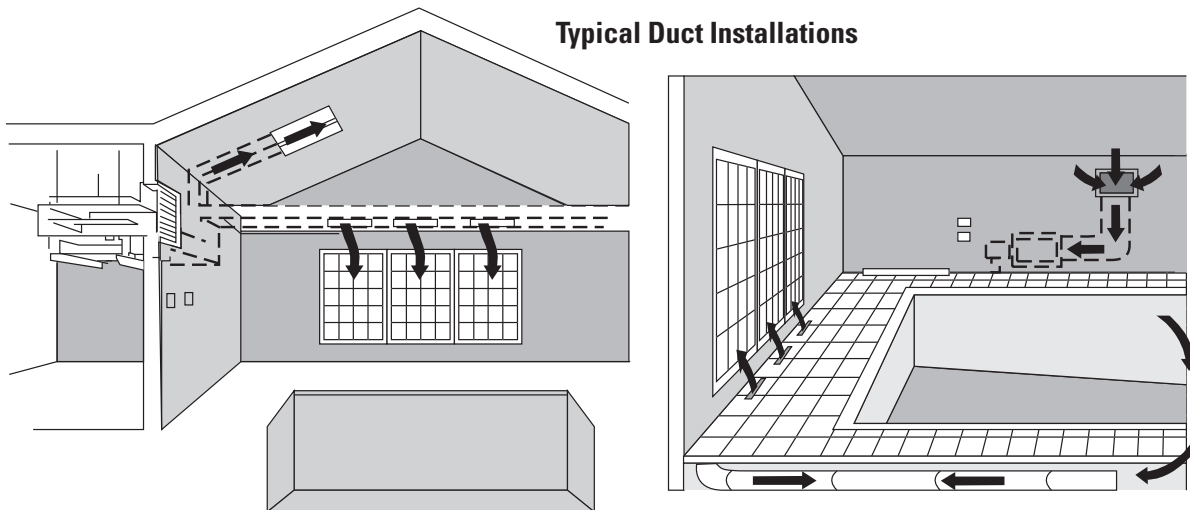

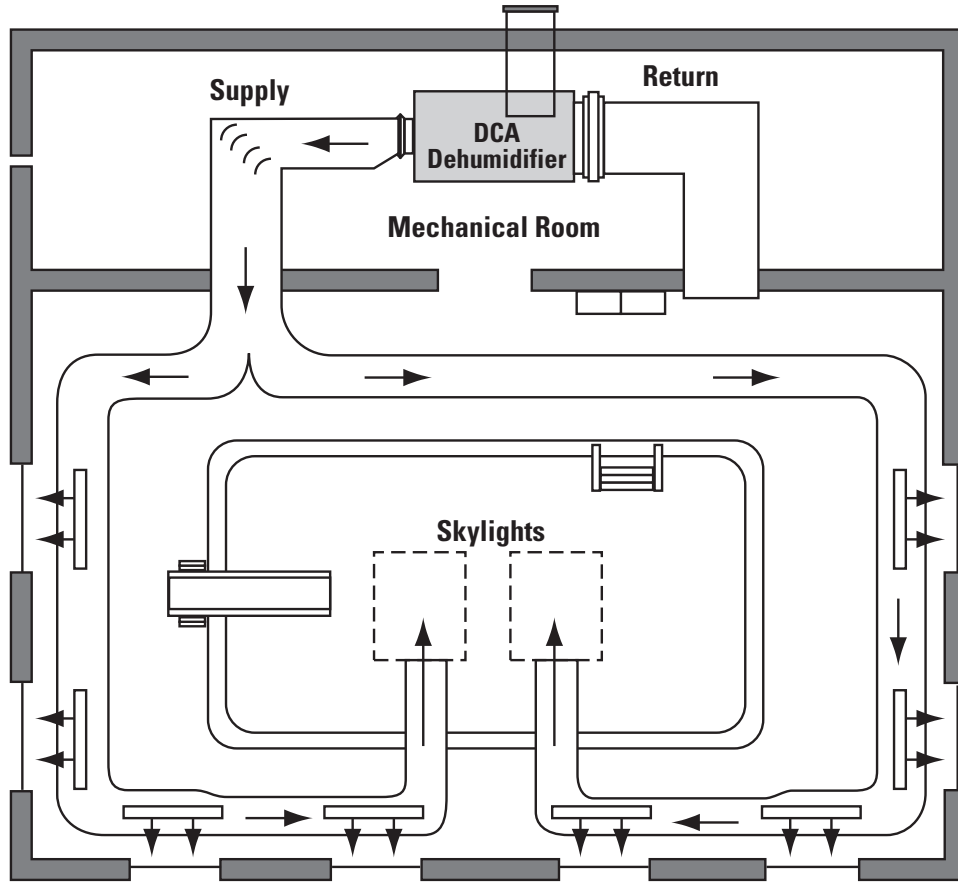

TYPICAL DUCTED POOL ROOM INSTALLATION

SMACNA DUCT DESIGNS

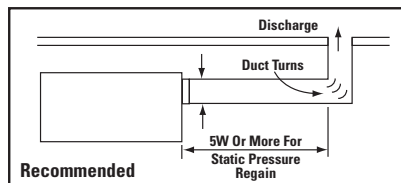
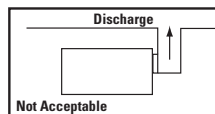
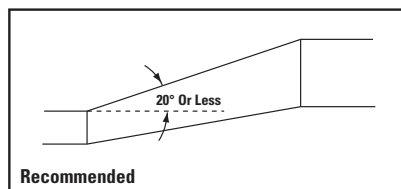
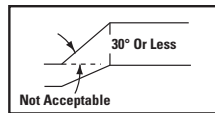
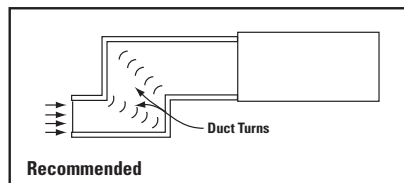
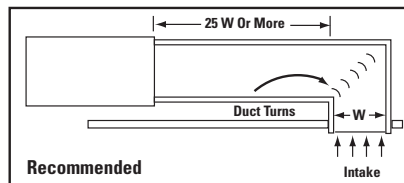
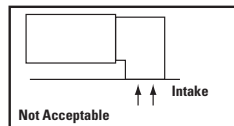

REMOTE CONDENSER INSTALLATION GENERAL

The remote condenser is normally located outdoors. Proper clearances must be maintained around unit to allow for service and maintenance. The intake of the remote must be at least 36" from any obstruction.

IMPORTANT

Provide at least 5 feet of clearance in front of and top of unit for proper unit operation.

The outdoor remote condenser must be installed above or at the same level as the dehumidifier. When installing the remote condenser below the dehumidifier more than eight feet, the factory must be consulted.

Hot gas and liquid line sizes that are stated on the unit and in the installation manual must be adhered to. The length of run of these lines must be 50 feet or less. Contact factory for runs over 50 feet.

THE DCA DEHUMIDIFIER IS A FLOODING HEAD PRESSURE CONTROLLER SYSTEM

Refer to the following chart when determining the required amount of additional refrigerant R22 to be weighed into system when corresponding remote condenser is added. Refrigeration lines (field supplied) should not exceed 50 feet in length. Contact DCA when longer lengths are need.

ATTENTION INSTALLERS

Only trained, qualified personnel should install or service DCA equipment. Serious injury, death and property damage can result from improper installation/service of this equipment. High voltage electrical components and refrigerant under pressure are present.

REFRIGERANT PIPING OF REMOTE CONDENSER

Refrigerant piping (supplied by others) must be dehydrated copper. Standard refrigerant practices must be used when a remote condenser is installed. Both outgoing and incoming refrigerant lines must be insulated to prevent dripping. Hot gas lines should have traps installed every 20 feet of vertical lift. The remote condenser is shipped with a

DEHUMIDIFIER MODEL#	PIPE SIZE	
	SUPPLY	RETURN
DCA500	5/8" OD	3/8" OD
DCA900	5/8" OD	3/8" OD
DCA1400	5/8" OD	1/2" OD
DCA2000	7/8" OD	1/2" OD
DCA2500	7/8" OD	1/2" OD
DCA3000	7/8" OD	5/8" OD
DCA3300	7/8" OD	5/8" OD
DCA3500	7/8" OD	5/8" OD
DCA3800	7/8" OD	5/8" OD
DCA4000	1 1/8" OD	7/8" OD
DCA4200	1 1/8" OD	7/8" OD
DCA5400	1 1/8" OD	7/8" OD
DCA7000	1 3/8" OD	7/8" OD

DCA8000 – A	1 1/8" OD	5/8" OD
– B	1 1/8" OD	5/8" OD
DCA9000 – A	1 1/8" OD	7/8" OD
– B	1 1/8" OD	7/8" OD
DCA110000 – A	1 1/8" OD	5/8" OD
– B	1 3/8" OD	7/8" OD
DCA140000 – A	1 3/8" OD	7/8" OD
– B	1 3/8" OD	7/8" OD

nitrogen holding charge. Remove this charge at the access ports provided before attempting to evacuate system. Refer to the following chart to determine the correct remote condenser line size required.

Service valves on the main unit are located in the blower compartment. Keep these service valves closed (front seated) until all soldering, evacuation and refrigerant charging is completed.

When installing line set, make sure that all solder joints are clean, oil free and absent of any foreign material. Insert copper into valve until line bottoms out in valve. Complete soldering process. Pressurize line set to determine if any leaks are present. Repair leaks, if any, and evacuate line sets and remote condenser down to 500 microns. Once the evacuation procedure has been completed, pressurize system with refrigerant and leak check with electronic detector. If no leaks are found, you can add additional refrigerant to the system.

Do not open service valves to remote condenser until all additional refrigerant is added. Refrigerant should be added at the remote condenser coil.

In the event the remote condenser coil will not accept all the additional refrigerant needed, add remaining at the receiver in the dehumidifier. The receiver is equipped with rotolock valves. Do not add refrigerant at the suction port of the unit. This could cause the compressor to slug with liquid refrigerant **AND VOID THE WARRANTY**.

Remote condenser coil must be kept clean from any grass clippings, leaves, dirt, etc. Failure to keep coil clean will result in poor unit performance and high operating costs. Do not cover remote condenser during cold months. Proper dehumidification requires year-round operation of remote condenser.

DEHUMIDIFIER MODEL#	REMOTE MODEL FOR 95°F AMB.	LBS, R-22
DCA500	ORC-050	8.0
DCA900	ORC-090	11.0
DCA1400	ORC-140	16.0
DCA2000	ORC-200	25.0
DCA2500	ORC-250	25.0
DCA3000	ORC-300	33.0
DCA3300	ORC-330	33.0
DCA3500	LORC-8	33.0
DCA3800	LORC-10	31.0
DCA4000	LORC-12	38.0
DCA4200	LORC-12	38.0
DCA5400	LORC-14	45.0
DCA7000	LORC-339	38.0
DCA8000	LORC-339	2 x 31
DCA9000	LORC-399	2x38
DCA110000	LORC-399	1-38, 1-31
DCA140000	LORC-525	2 x 38

AIR FLOW BALANCING

All DCA units are shipped from the factory with the airflow set at the standard CFM for your particular model and .5 WC external static pressure E.S.P. Refer to DCA specification sheet for more information.

To verify unit will deliver required CFM and adequate E.S.P. when installed in your application, a simple check must be performed. **An incline monometer, digital monometer or pressure differential gauge must be used.**

CHART A

Shows the location of the air balancing access ports and where to insert the HI and LO pressure tubes of the monometer or gauge. Measure the pressure differential across the reheat condenser coil to verify air flow.

Chart A

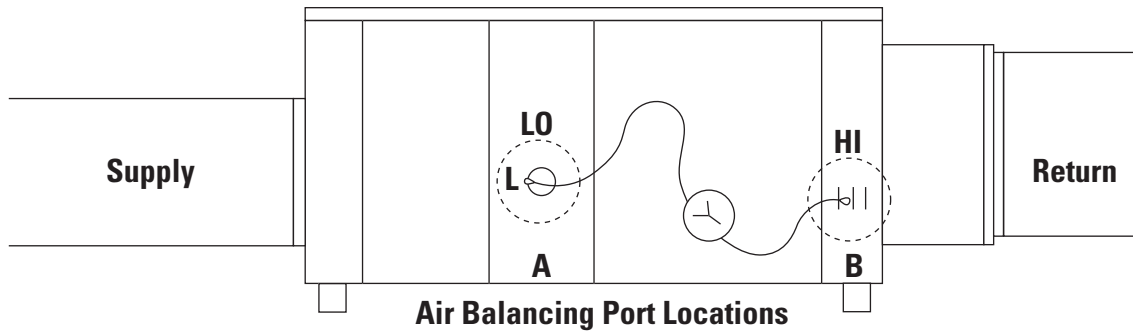

CHART B

Shows the static pressure drop across the reheat condenser coil at standard CFM for each DCA model at .5 E.S.P.

Chart B

UNIT	STANDARD CFM	STATIC PRESSURE DROP (INCHES W.C.) AT .5 E.S.P.
DCA500	550	
DCA900	950	
DCA1400	1425	
DCA2000	2000	
DCA2500	2500	
DCA3000	3000	
DCA3300	3500	
DCA3500	3500	
DCA3800	3800	SEE LABEL ON UNIT
DCA4000	4000	
DCA4200	4200	
DCA5400	5300	
DCA7000	6900	
DCA8000	8000	
DCA9000	9000	
DCA110000	10,850	
DCA140000	13,600	

If pressure differential reading differs from the chart, the following steps should be taken:

1. PRESSURE LOWER THAN CHART

- A. Check for restrictions in duct work such as closed registers, blocked return air grills or dampers in duct work not adjusted properly.
- B. Check filters to verify that they are clean.
- C. Check belt tension. The belt should have approximately 1" of play up or down. Replace any worn or frayed belt.
- D. If duct work is free of obstructions, the adjustable motor pulley should be closed until correct pressure reading is achieved.

2. PRESSURE HIGHER THAN CHART

- A. Unit does not have duct work or dampers in duct work not adjusted properly.
- B. Air filters not in unit.
- C. To reduce air flow pressure, open adjustable motor pulley and reset belt tension to 1" play up or down until correct pressure reading is achieved.
- D. In a no duct work installation (Free blow) a 4 foot duct extension must be installed on supply outlet of unit. Adjust motor pulley following the instructions above.

NON DUCTED INSTALLATIONS

When the installation of duct work is not possible the unit must be positioned in such a manner that return air into the unit is not obstructed and sufficient air can enter the unit. Place unit usually high in the room out of reach of users but accessible for normal maintenance and service.

Direct air from supply of unit toward exterior glass, skylights and walls. Short cycling of air or loop effect will give poor performance. Position for optimum air circulation for best results.

UNIT OPERATION

ATTENTION INSTALLERS / OPERATORS

Main power to the unit crankcase heater must be on for 12 hours before unit is started. Under no circumstances should the unit be run for temporary heat when building construction is in progress or when there is no water in the pool.

HUMIDISTAT

This control turns the unit on or off when the humidity in the room rises above or falls below the set point of the control.

Control is factory set and covers a humidity range of 20% to 80%. Typical pool room humidity setting would be between 50% to 60%. Remember that the lower the humidity setting the longer the unit will run and the higher the operating costs.

AUTOMATIC CHANGEOVER THERMOSTAT

Other control systems may be provided. The following explains standard snap action humidistat and auto change over thermostat. See additional instructions for other control systems available, not in this manual.

This control maintains the temperature in the room. Set thermostat at desired temperature, usually between 75° F to 85° F. The thermostat is an automatic change over type which will automatically switch to air conditioning (with remote condenser option) or heating. This thermostat provides the following operating options.

SYSTEM SWITCH

HEAT - In the heat position unit will supply warm air to room. Unit will start on a call from either the humidistat or thermostat. If unit does not have remote condenser option system switch must be set in heat position.

COOL - This position must not be used. See auto position.

AUTO - This position allows the unit to run and supply either warm air or cool air to the room. The unit will run in the cooling cycle if temperature rises above set point or in the heating cycle if temperature drops below set point.

OFF - This position disengages the unit regardless of temperature or humidity.

**IN NO CIRCUMSTANCE
ALLOW THE RETURN AIR OF UNIT,
WITH NO DUCT WORK ATTACHED,
TO BE PLACED IN SAME ROOM
AS POOL HEATERS OR ANY OTHER
FOSSIL FUEL BURNING APPLIANCES.
DEATH CAN RESULT**

FAN SWITCH

ON - Blower runs continuously regardless of temperature or humidity setting.

AUTO - Blower will operate only when thermostat is calling for Heating or Cooling or Humidistat is calling for Dehumidification.

UNIT START-UP PROCEDURE

Read this manual carefully before attempting to operate the Dehumidifier. Startup report must be completed and returned to DCA or warranty is void.

The following check list must be verified before start-up of unit.

1. Power supply connected and compared with unit nameplate voltage requirement. (See unit specifications)
2. Unit properly grounded.
3. Check and tighten all factory and field wiring connections.
4. Clean air filters installed.
5. Check and adjust belt tension. Belt should deflect approximately 3/4" to 1" midway on the belt.
6. Condensate drain line is free of obstructions and is leak free.
7. check level or pitch of unit to be sure that condensate water flows freely from outlet of drain. A simple test is to pour water into drain pan of unit and verify that water flows out of unit. This will also fill the P-Trap.
8. Outdoor remote condenser properly grounded. (If equipped)
9. Power supply connected to remote condenser as per nameplate. (If equipped)
10. Set humidistat below room condition. Unit should start in reheat condenser mode if remote condenser equipped.
11. Set thermostat below room condition. Unit should start if remote condenser equipped.
12. check temperature of air in heat mode. Temperature should be 10°F to 20°F lower than room temperature.
13. Check temperature of air in cooling mode (If equipped). Temperature should be 10°F to 20°F lower than room temperature.
14. Return humidistat and thermostat to normal settings. Typically between 50% RH and 60% RH and 82°F to 88°F.

MAINTENANCE AND SERVICE PROCEDURE

Your DCA Dehumidifier requires minimal maintenance. The following areas should be checked as required.

1. Air filters should be checked once per month. Dirty filters should be replaced immediately. Replacement filters should be available locally. Dirty and clogged filters will seriously effect performance of unit.

Locate your unit in the following information to determine the size and quantity of filters required.

MODEL	FILTER SIZE	QUANTITY
DCA500	20 x 20 x 1	1
DCA900	25 x 25 x 1	1
DCA1400	25 x 25 x 1	1
DCA2000	18 x 25 x 1	2
DCA2500	18 x 25 x 1	2
DCA3000	20 x 25 x 1	2
DCA3300	20 x 25 x 1	2
DCA3500	20 x 25 x 1	4
DCA3800	20 x 25 x 1	4
DCA4000	20 x 25 x 1	4
DCA4200	20 x 25 x 1	4
DCA5400	20 x 25 x 1	4
DCA7000	20 x 25 x 4	4
DCA8000	20 x 25 x 4	6
DCA9000	20 x 25 x 4	6
DCA110000	20 x 24 x 4	9
DCA140000	20 x 24 x 4	9

Check blower belt tension once every six months. Turn power supply off when inspecting belt. If belt is found to be worn or frayed replace with a new belt of same size and rating. Turn power supply on after belt has been replaced.

2. Blower motor and blower have permanently lubricated bearings that do not require any additional lubrication.
3. Check drain pan every six months and clean out any residue that may have built up.
4. Coils should be checked annually for dirt build-up and cleaned if necessary.
5. Re-tighten ALL electrical connections every six months.

IN CASE OF POWER FAILURE, EQUIPMENT MALFUNCTION OR OTHER CIRCUMSTANCES NOT IN THE UNIT CONTROL, THE POOL SURFACE SHOULD BE COVERED WITH A SUITABLE COVER.

CAUTION

In the event of unit malfunction it is recommended that a qualified service technician be notified for unit repair or service. Danger of electrical shock and refrigerant under pressure are present which could result in death.

DCA500WH - DCA14000WH INSTALLATION POOL WATER HEATING DEHUMIDIFIERS

POOL WATER PIPING:

Schedule 40 CPVC thermoplastic or copper piping is recommended. Standard PVC, aluminum, galvanized, black iron and cast iron piping must not be used.

The O.D. size of the supply and return water piping must not be downsized from the connection on the DCA Dehumidifier. If the main by-pass valve is more than 10 feet from the dehumidifier, increase the pipe size one size up. Both the supply and return pipe should be insulated for best results.

It is very important that the water flow be verified and matches the chart below.

IMPORTANCE OF POOL WATER CHEMISTRY

It is the responsibility of the indoor pool, spa, whirlpool or water park owner to maintain correct pool water chemistry. Poor pool water quality caused by out of balance pool or spa water chemistry is a serious health and comfort problem. Many times the so called offensive "pool water smell" is a tip off that this water chemistry needs attention. It is the responsibility of the pool or spa manager to test the water chemistry daily with a pool water test kit. This kit will analyze PH - total alkalinity - free available and combined chlorine in the water. Proper pool water treatment procedures can only be obtained from the pool, spa or whirlpool equipment or pool water chemical suppliers. With this also is the verification of proper pool or spa water temperature.

DCA MODEL #	DCA 900WH	DCA 1400WH	DCA 2000WH	DCA 2500WH	DCA 3000WH	DCA 3300WH	DCA 3500WH	DCA 3800WH	DCA 4000WH	DCA 4200WH	DCA 5400WH	DCA 7000WH
GPM at 25°F Diff.	4.0	5.0	8.0	11.0	11.0	15.0	17.0	21.0	24.0	36.0		
Pipe Pressure Drop ft. H ₂ O	7.0	4.0	7.7	6.5	8.2	8.2	6.7	7.7	10.7	12.4		

DCA MODEL #	DCA 8000WH(A)	DCA 8000WH(B)	DCA 9000WH(A)	DCA 9000WH(B)	DCA 11000WH(A)	DCA 11000WH(B)	DCA 14000WH(A)	DCA 14000WH(B)
GPM at 25°F Diff.	17.0	17.0	21.0	21.0	17.0	36.0	36.0	36.0
Pipe Pressure Drop ft. H ₂ O	6.7	6.7	7.7	7.7	6.7	12.4	12.4	12.4

Poor pool or spa water chemistry will result in the formation of scale and corrosion within the dehumidification system which will drastically shorten the effective service life of the dehumidifier.

FAILURE TO FOLLOW THE ABOVE RECOMMENDATIONS WILL RESULT IN THE VOIDING OF ALL WARRANTIES FROM DCA THAT WERE EITHER EXPRESSED, IMPLIED OR WRITTEN.

STORAGE OF POOL OR SPA WATER CHEMICALS:

This is an area of swimming pool or spa management that most times is either neglected or forgotten about altogether with often dire consequences. Pool water chemicals, by their very nature, are some of the most corrosive chemicals that are available for non-professional use.

Under no circumstances should the storage of spa or pool water chemicals be in the same room with the

dehumidifier. The very corrosive effects of these disinfectant will quickly attack any and all metal surfaces it comes in contact with. Not only will the dehumidification system be effected, but also any pool or spa water heating systems, pumps or other mechanical devices such as controls be adversely affected.

Proper storage must be in another area of the building or in a sealed non-metallic cabinet that will ensure that no vapor release of the chemicals will occur. It will be easy to detect, if the early failure of equipment occurs, that improper chemical storage was the cause.

FAILURE TO FOLLOW THE ABOVE RECOMMENDATIONS WILL RESULT IN THE VOIDING OF ALL WARRANTIES FROM DCA THAT ARE EITHER EXPRESSED, IMPLIED OR WRITTEN.

LEGEND

1. DCA Water Cooled Dehumidifier
2. Optional Remote Condenser (A/C)
 - A. Air Cooled Model Shown
 - B. Water Cooled Model Available
 - C. Cooling Tower Loop Available
3. Main Pool Circulating Pump (By Others)
4. Auxiliary Pool Water Heater (By Others)
5. Pool Water Filter
6. Auxiliary Pool Water Pump (By Others) Supplies Pool Water To Dehumidifier Water Heater
7. Make-up Air Assembly (By Others)
 - A. Air Filter
 - B. Damper Control and Timer
 - C. Outside Air Pre-Heater
 - D. Bird Screen & Termination
8. Mounting feet and vibration isolators by others.
9. Electric/Gas/Hot Water Add On Duct Heater (By Others)
10. Vibration Isolator Duct Connector (By Others).
11. Flow Control and Shut-Off Valve (By Others)
12. P-Trap and Condensate Return (By Others)
13. Air Vent (By Others)
14. Electrical Access Door
15. Dehumidifier Component Access Doors
16. Balancing valve.

Note: This is a generic drawing. Location of piping and components may vary from unit to unit.

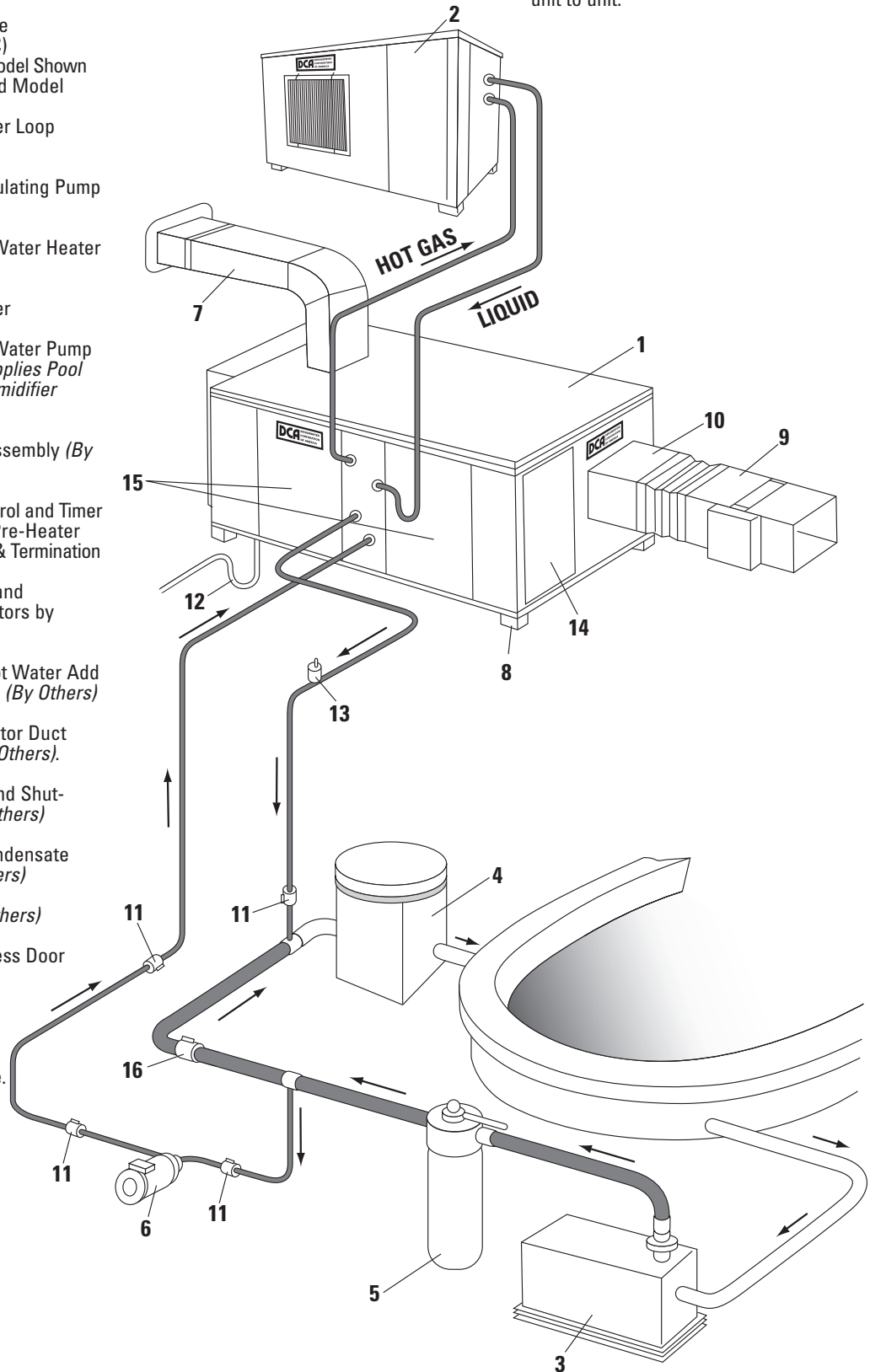

TROUBLESHOOTING

(The following is a guide for the owner/user to follow in the event the unit malfunctions. If further service is required, a qualified service technician must be called.)

PROBLEM	POSSIBLE CAUSE	SOLUTION
Unit does not start	Main power off.	Turn main Power On. Reset circuit breaker or replace blown fuses.
	Thermostat system switch in off position.	Set system switch in automatic position.
	Humidistat turned off.	Turn humidistat on and set to desired RH level, usually between 50% to 60% R.H.
	Humidistat set too high.	Lower humidistat setting.
	Thermostat system switch in off position.	Set system switch in automatic position.
Unit does not shut off	Malfunctioning controls.	Call service technician to repair or replace control.
Unit not operating properly, high humidity in room	Humidistat turned off.	Turn humidistat on and set to desired RH level, usually between 50% to 60%.
	Air filters dirty.	Replace filter(s).
	Controls located in room that is not being treated by dehumidifier.	Change location of controls into room being treated by dehumidifier.
	Pool water temperature too high.	Lower pool water temperature usually between 78°F to 82°F. Usually 2°F to 4°F below room temperature.
	Supply or return air registers blocked or closed.	Remove blockage and open registers. Check diffusers, make sure they are pointed in proper direction.
	Blower belt loose & slipping.	Check for worn belt and tighten or replace as necessary.

SERVICE DIAGNOSIS

(The following is a guide intended for use by qualified service personnel only. CAUTION High Voltage and refrigerant under high pressure present.)

PROBLEM	POSSIBLE CAUSE	SOLUTION
Compressor will not start	Broken or loose wire.	Check all wire & connections.
	Compressor off on internal overload.	Allow to cool, will start automatically.
	Low voltage to unit.	Check voltage and correct.
	High pressure switch tripped.	Press reset switch.
	Low pressure switch tripped.	Check refrigerant charge.
	Compressor discharge temperature switch tripped.	Check refrigerant charge.
	Defective start relay, start capacitor, run capacitor, transformer or compressor.	Replace defective component.
Dehumidifying coil iced up	Return air below 45°F.	Raise return air temperature.
	Filters dirty or clogged.	Replace filters.
	Low air flow.	Check blower motor and belt.
		Adjust blower speed.
		Check blower rotation.
		Check duct design. Refer to manual for proper sizing and design.
	Low refrigerant Charge.	Add Refrigerant. (See charging procedure)
	Bad expansion valve.	Replace expansion valve.
	Restricted drier.	Replace drier.
Restricted distributor tubing.	Replace distributor tubing.	
Restricted distributor.	Replace distributor.	

SERVICE DIAGNOSIS

(The following is a guide intended for use by qualified service personnel only. CAUTION High Voltage and refrigerant under high pressure present.)

PROBLEM	POSSIBLE CAUSE	SOLUTION
High head pressure	Low air flow.	Adjust blower speed.
	Return air short cycling.	Check duct design and readjust supply and return air registers.
	Refrigerant overcharge.	Adjust refrigerant. (See charging procedure).
	Non-condensable in system.	Evacuate and recharge system.
	Dirty coils.	Clean all coils in unit and remote if equipped.
	Dirty filters.	Replace filters.
Head pressure switch tripping (Same as above)	Blower running too slow.	Adjust blower speed up.
	Blower turning backwards.	Change blower rotation. (3 phase only)
	Motor going off on internal overload.	Check for rated AMP draw. Replace motor if defective.
	Dirty filters.	Replace filters.
	Supply and return air registers restricted or blocked.	Remove restrictions or blockages.
	Refrigerant overcharge.	Adjust refrigerant. (See charging procedure).
	Dirty coils.	Clean all coils in unit and remote if equipped.
	Defective head pressure switch.	Replace head pressure
Low head pressure	Low refrigerant charge.	Add refrigerant. (See charging procedure).
	Return air temperature too low.	Return air temperature must be minimum 45°F.

SERVICE DIAGNOSIS

continued

(The following is a guide intended for use by qualified service personnel only. CAUTION High Voltage and refrigerant under high pressure present.)

PROBLEM	POSSIBLE CAUSE	SOLUTION
High suction pressure	High air flow.	Incorrect duct work causes stratification of air on inlet.
	Return air temperature too high.	Lower temperature in room.
	Defective compressor.	Replace compressor.
Low suction pressure	Refrigerant charge low.	Adjust refrigerant. (See charging procedure)
	Low air flow.	Adjust blower speed. Check blower, motor and pulley.
	Return air temperature too low.	Raise return air temperature.
	Dirty filters.	Replace filters.
High humidity in space	Incorrect duct work.	Check duct work design. (See manual)
	Low air flow.	Adjust blower. Check blower, motor and pulley.
	Dirty filters.	Replace filters.
	Outdoor condenser not operating properly.	Clean outdoor coil and check blower, motor and belt.
	Refrigerant system overcharge.	Check pressures. Adjust per manual.
	Unit too small or not enough capacity to handle humidity and problem.	Refer to guide lines regarding sizing dehumidifiers for load and applications.

DCA SERIES HUMIDITY CONTROL SYSTEMS LIMITED PRODUCT WARRANTY

MODELS

DCA500 • DCA500/WH • DCA900 • DCA900/WH • DCA1400 • DCA1400/WH • DCA2000 • DCA2000/WH • DCA 2500
DCA 2500/WH • DCA 3000 • DCA 3000/WH • DCA 3300 • DCA 3300/WH • DCA 3500 • DCA 3500/WH • DCA3800 • DCA 3800/WH
DCA 4000 • DCA 4000/WH • DCA 4200 • DCA 4200/WH • DCA 5400 • DCA 5400/WH • DCA 7000 • DCA 7000/WH • DCA 8000
DCA 8000/WH • DCA 9000 • DCA 9000/WH • DCA 11000 • DCA 11000/WH • DCA 14000 • DCA 14000/WH

This certificate is our warranty to you. Please insure that you or your installing dealer understand this warranty. Dehumidifier Corporation of America, Inc. applies this limited warranty on all units of its manufacture to be free from defects in material and workmanship under normal intended use and service when units remain at original installation site and are correctly installed and operated according to printed instructions and in compliance with all local installation and building codes and acceptable trade practices.

This Limited Warranty is void unless upon start-up of the unit the "Start-up Report and Warranty Registration" is completed and received at the factory within 30 days of start-up. This will also register the compressor warranty with the compressor manufacturer.

The company shall, unless specified herein, during the first three years after date of initial installation replace any part supplied by DCA that fails because of a defect in workmanship or material.

All controls, supplied by DCA, as part of a dehumidification system will carry a one (1) year warranty from date of start up as validated by the return of the start up report returned to DCA no later than 30 days after the start up date.

All freon compressors and all other parts excluding return air filters and blower belts, carry a three year parts warranty. DCA will furnish a replacement

compressor, upon a compressor failure, shipped freight collect. Subsequent compressor replacements, on a no cost basis, will be at the discretion of DCA and will be handled on a case by case basis. Normally after the second compressor fails, within the 3 year warranty period, a problem exists in the installation, maintenance or causes beyond the control of DCA such as and not limited to power fluctuations or lightning strikes. The cause of failure must be determined before any action is taken by DCA.

Refrigeration coils, as part of the DCA dehumidification system, carry a three year warranty. DCA will furnish a replacement refrigeration coil, upon a coil failure, shipped freight collect. Subsequent coil replacements, on a no cost basis, will be at the discretion of DCA and handled on a case by case basis. Normally after the second coil fails within the 3 year warranty period, a problem exists in the installation, maintenance or causes beyond the control of DCA. Premature coil fin erosion normally signals that chemicals are stored in the mechanical room, with the dehumidifier, or contaminated return air is present and must be corrected before any action is taken by DCA.

The definition of a defective dehumidifier part will be as follows. In the case of a defective part, that falls in the definition of its warranty period, the replacement part will be shipped from the factory promptly with the customer being billed immediately via COD, a valid credit card via an existing open account with DCA. The

defective part will be shipped back to the DCA factory with all associated costs being paid by the customer. Upon return, the defective part will be examined for cause of failure. If it is determined that the part was found to be defective in materials or workmanship, DCA will immediately credit the customer back via the same initial method of payment. All the associated freight costs will be paid for by the contractor or owner. If DCA has determined that the returned part was subjected to miss use or alteration, warranty will be denied.

DCA will supply a new or replacement part free. All in-warranty replacement parts will be warranted for the unused portion of that component's warranty as established herein. Freight charges on warranty replacements are the responsibility of the owner. Any charges associated with labor, material, refrigerant or any other charges with the repair will be the responsibility of the owner.

There is no warranty for any of the following:

(1) Alteration, misuse, negligence, accident, floods, or Acts of God. (2) If operation of the unit is contrary to the company or manufacturer's recommendation or (3) if any unit has been altered or repaired by improper matching of the unit or units components in any way outside of the factory, so as to affect its stability or performance in our judgement. (4) Any damages caused by failing to provide maintenance and service to the unit. (5) Any Labor cost incurred in diagnosing, erecting or disconnecting, or any damage or repairs required as a result of faulty installation or replacing any parts or any parts used in connection with normal maintenance, such as filters or belts. (6) Fuel or electricity costs or any increase in electricity of fuel costs whatsoever including any additional or unusual use of supplemental heat. (7) Actions or negligence of the installer or servicer of the unit that result in losses or damage of any kind including those due to inadequate: (A) Sizing of the unit to the area. (B) Air Distribution. (C) Duct Work and (D) Poorly insulated or loosely constructed rooms.

(E) Excessive glass or skylights on outside cold walls.

(F) Excessive infiltration. (G) Power supply. **THIS**

WARRANTY DOES NOT INCLUDE SERVICE OR LABOR CHARGES CONNECTED WITH THE DETERMINATION OR REPLACEMENT OF DEFECTIVE PARTS. ALL LABOR CHARGES ARE THE RESPONSIBILITY OF THE INSTALLING CONTRACTOR FOR THE LENGTH OF HIS WARRANTY, IF ANY, AND THEREAFTER THE OWNER.

Sheet metal expendable supplies such as refrigerants, solder, fluxes, and repairable coils are not included as part of this warranty. Buyer's sole and exclusive remedy with respect to the product are provided in this warranty and the expressed warranties contained herein are in lieu of all other warranties.

IMPLIED WARRANTIES INCLUDING WARRANTIES OF MERCHANTABILITY OR FITNESS FOR A PARTICULAR USE OR PURPOSE, SHALL ONLY LAST FOR ONE YEAR AFTER DATE OF ORIGINAL INSTALLATION.

Buyer assumes all other liability for any loss, damage or injury to persons or property, arising out of, connected with or resulting from the use of the Company's Products, either alone or in combination with other products. In no event shall the company be liable for any other damages, either direct, incidental, consequential, or otherwise. Some states do not allow limitations on how long an implied warranty lasts or the exclusions of consequential or incidental damages, so the above limitations and exclusions may not apply. This warranty gives you specific legal rights and you also may have other rights which vary from state to state.

ALL CLAIMS RELATING TO OR ARISING OUT OF THE OPERATION OF THIS PRODUCT ARE SUBJECT TO BINDING ARBITRATION UNDER THE AUSPICES AND RULES OF THE AMERICAN ARBITRATION ASSOCIATION.

STARTUP REQUIREMENTS

The following items are required and must be completed before startup can be performed by the manufacturer's representative.

1. All installations and wiring diagrams must be studied and understood before proceeding with the installation. If there are any questions contact the factory.
2. All wiring must be completed. This includes main power, control and sensors.
3. All refrigeration and/or water piping must be completed.
4. All additional refrigerant required per instructions must be added.
5. Proper water flow, if required must be established.
6. Duct work, including duct, grills and diffusers must be completed.
7. A thorough leak check should be performed. Due to the fact that the unit may be damaged while in transit we recommend that all field and factory connections be leak checked.

In addition a refrigeration mechanic from the installing contractor must be on site with the following tools.

1. Manifold set/or sets for pressure readings.
2. Air flow meter/s. Magnehelics in the ranges 0 to 1.0 in. w. c. and 0 2.0 in. w. c.
3. Volt-Ohm-Amp meter/s.
4. Temperature meters with probes and strap on bulbs, and sling psychrometer.
5. Assorted refrigeration and standard tools.
6. All maintenance personnel to be responsible for the unit service should be made available.