



SAMSUNG

SPLIT-TYPE AIR CONDITIONER

Basic : AQV09VBA

AQV12VBA

Model : AQV09VBC

AQV12VBC

Model Code : AQV09VBCN

AQV09VBCX

AQV12VBCN

AQV12VBCX

SERVICE Manual



AMG
Air Marketing Group LLC

AIR CONDITIONER



AQV09VBCN, AQV12VBCN



AQV09VBCX, AQV12VBCX

THE FEATURE OF PRODUCT

■ **High Energy Efficiency BLDC Air Conditioner**

■ **Luxury Half Mirror Design**

■ **good'sleep Mode**

: good'sleep Mode can help you sleep quickly and soundly and wake up refreshed.

■ **mpizone Mode**

: The Micro Plasma Ion mode creates strong purified zone in your room.

■ **Silence Mode**

: When you use the "Silence Mode", you can experience extremely quiet operation of your air conditioner.

Refer to the service manual in the GSPN(see the rear cover) for the more information.

Air Marketing Group LLC

141 Kinderkamack Rd, Park Ridge, NJ 07656 Tel: 201-782-1782 Fax: 201-782-1783 Web: www.amgair.com Email: info@amgair.com

Contents

1. Precautions	1-1
1-1 Installing the air conditioner	1-1
1-2 Power supply and circuit breaker	1-1
1-3 During operation	1-1
1-4 Disposing of the unit	1-2
1-5 Others	1-2
2. Product Specifications	2-1
2-1 The Feature of Product	2-1
2-2 Product Specifications	2-2
2-3 The Comparative Specifications of Product	2-3
2-4 Accessory and Option Specifications	2-5
3. Alignment and Adjustments	3-1
3-1 Test Mode	3-1
3-2 Indoor Display Error and Check Method	3-2
3-3 Outdoor LED Error Display and Check Method	3-3
3-4 Setting Option Setup Method	3-4
4. Disassembly and Reassembly	4-1
4-1 Indoor Unit	4-2
4-2 Outdoor Unit	4-5
5. Exploded Views and Parts List	5-1
5-1 Indoor Unit	5-1
5-2 Outdoor Unit	5-3
5-3 Ass'y Control In	5-5
5-4 Ass'y Control Out	5-7
6. Electrical Parts List	6-1
7. Wiring Diagram	7-1
7-1 Indoor Unit	7-1
7-2 Outdoor Unit	7-2
8. Schematic Diagram	8-1
8-1 Indoor Unit	8-1
8-2 Outdoor Unit	8-2

Contents

9. Circuit Descriptions	9-1
9-1 PCB Circuit Descriptions	9-1
9-2 Refrigerating Cycle Diagram	9-3
10. PCB Diagram	10-1
10-1 Indoor PCB	10-1
10-2 Outdoor PCB	10-2
11. Operating Instructions	11-1
11-1 Name of Each Part	11-1
11-2 Wireless Remote Control-Buttons and Display	11-3
11-3 Main Function	11-4
12. Troubleshooting	12-1
12-1 Items to be checked first	12-1
12-2 Fault Diagnosis by Symptom	12-2
12-3 PCB Inspection Method	12-20
12-4 Main Part Inspection Method	12-22
13. Block Diagram	13-1
13-1 Indoor Unit	13-1
13-2 Outdoor Unit	13-3
14. Reference Sheet	14-1
14-1 Index for Model Name	14-1
14-2 Low Refrigerant Pressure Distribution	14-2
14-3 Pressure & Capacity mark	14-3
14-4 Q & A for Non-trouble	14-4
14-5 Cleaning/Filter Change	14-7
14-6 Installation	14-9
14-7 Installation Diagram of Indoor Unit and Outdoor Unit	14-10

1. Precautions

1-1 Installing the air conditioner

- Users should not install the air conditioner by themselves.
Ask the dealer or authorized company to install the air conditioner except the window-type air conditioner in U.S.A and Canada.
- If you don't install the air conditioner properly, it may cause a fire, a water leakage or an electric shock.
- You must install the air conditioner according to the national wiring regulations and safety regulations.
- Install the indoor unit higher than 2.5m from the floor to avoid the injury caused by the operation of the fan.
(except the window-type air conditioner)
- The manufacturer is not responsible for any accidents or injury caused by an incorrect installation.
- When installing the built-in type air conditioner, keep all electric cables such as the power cable and the connection cord in pipes, ducts, or cable channels to protect them from the danger of impact or any other incidents.

1-2 Power supply and circuit breaker

- If the power cord of the air conditioner is damaged, it must be replaced by the manufacturer or a qualified person in order to avoid a hazard.
- The air conditioner must be plugged into an independent circuit if applicable or connect the power cable to the auxiliary circuit breaker.
An all pole disconnection from the power supply must be incorporated in the fixed wiring with a contact opening of >3mm.
- Do not extend an electric cord to the air conditioner.
- The air conditioner must be plugged in after you complete the installation.



1-3 During operation

- Do not repair the air conditioner at your discretion.
It is recommended to contact a service center directly.
- Never spill any kind of liquid on the air conditioner.
If this happens, turn off the air conditioner and contact an authorized service center.
- Do not insert anything between the airflow blades to prevent damage of the inner fan and consequent injury.
Keep children away from the air conditioner.
- Do not place any obstacles in front of the air conditioner.
- Do not spray any kind of liquid into the indoor unit. If this happens, turn off the air conditioner and contact a service center.
- Make sure that the air conditioner is well ventilated at all times:
Do not place a cloth or other materials over it.
- Remove the batteries if you don't use the remote control for a long time. (If applicable)
- Use the remote control within 7 meters from the indoor unit. (If applicable)

1-4 Disposing of the unit

- Before throwing out the air conditioner, remove the batteries from the remote control.
- When you dispose of the air conditioner, consult your dealer. If pipes are removed incorrectly, refrigerant may blow out and cause air pollution. When it contacts with your skin, it can cause skin injury.
- The package of the air conditioner should be recycled or disposed of properly for environmental reasons.

1-5 Others

- Never store or load the air conditioner upside down or sideways to prevent the damage to the compressor.
- Young children or infirm persons should be always supervised when they use the air conditioner.
- Max current is measured according to IEC standard for safety.
- Current is measured according to ISO standard for energy efficiency.

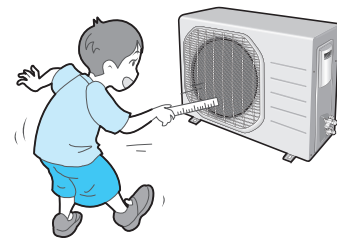

2. Product Specifications

■ **High Energy Efficiency BLDC Air Conditioner**

BLDC Technique arises the efficiency of air conditioner and makes a room cool and warm with high energy saving.

■ **Luxury Half Mirror Design**

With a Luxurious and Fashionable style, the high impressive interior design allow this product to set place in anywhere.

■ **good'sleep Mode**

good'sleep Mode can help you sleep quickly and soundly and wake up refreshed.

■ **mpizone Mode**

The Micro Plasma Ion mode creates strong purified zone in your room.

■ **Silence Mode**

When you use the "Silence Mode", you can experience extremely quiet operation of your air conditioner.



2-2 Product Specifications







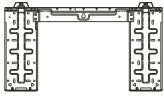

Item				Model		AQV09VBC		AQV12VBC			
				Indoor Unit	Outdoor Unit	Indoor Unit	Outdoor Unit				
Type				Wall-mounted		Wall-mounted					
Performance	Capacity	Cooling	kW (Low / Std / Max)	0.99 / 2.50 / 3.20		0.99 / 3.50 / 4.00					
		Heating		0.99 / 3.50 / 4.50		0.99 / 4.00 / 5.20					
	Running Frequency	Cooling	Hz (Low / Std / Max)	20 / 46 / 61		20 / 71 / 81					
		Heating		20 / 66 / 85		20 / 77 / 95					
	Dehumidifying			ℓ/h	1.4		1.6				
	Air Volume	Cooling	m ³ /min (H/M/L)	8.6/8.1/7.6		28		8.9/8.3/7.6		28	
		Heating		9.5/8.9/8.3		27		10/9.4/8.8		27	
	Noise	Cooling	dB (H/L)	41/25		51		43/25		53	
		Heating		41/25		51		43/25		53	
	Energy Efficiency Ratio	Cooling	W/W (Std)	4.10		3.40					
Heating		4.10		3.64							
Power			ph-V-Hz	1-220/240-50		1-220/240-50					
Power	Power Consumption	Cooling	W (Low / Std / Max)	240 / 610 / 840		240 / 1030 / 1200					
		Heating		200 / 853 / 1450		200 / 1100 / 1600					
	Operating Current	Cooling	A (Low / Std / Max)	1.5 / 3.0 / 4.0		1.5 / 4.8 / 5.8					
		Heating		1.4 / 4.5 / 6.0		1.4 / 5.2 / 7.0					
	Power Factor	Cooling	%	70 / 85 / 90		70 / 90 / 90					
		Heating		70 / 85 / 90		70 / 90 / 90					
	Power Cord	Length		m	2		2				
		Number of Core Wire			3		3				
		Capacity		A	10		10				
	Size	Outer Dimension		Width x Height x Depth	mm	825 X 285 X 189	790 X 548 X 285	825 X 285 X 189	790 X 548 X 285		
Weight (Net)			kg	9.0	32.6	9.0	32.6				
Refrigerant Pipe		Liquid		mm x L(m)	Φ6.35 x 5		Φ6.35 x 5				
		Gas		mm x L(m)	Φ9.52 x 5		Φ9.52 x 5				
Drain Hose			D x L(mm)	Φ18 x 550		Φ18 x 550					
Compressor		Type			Rotary, G4C090LUDER		Rotary, G4C090LUDER				
		Motor	Type			Hermetic		Hermetic			
			Rated Output			853W		853W			
Oil Type				FREOLa68ES-T		FREOLa68ES-T					
Blower		Type			Cross-flow	Propeller	Cross-flow	Propeller			
	Motor	Type			Resin / Steel, AC	Resin / Steel, DC	Resin / Steel, AC	Resin / Steel, DC			
		Rated Output			W	27	25	27	25		
Heat Exchanger					2 Row 14 Step	1 Row 24 Step	2 Row 14 Step	1 Row 24 Step			
Refrigerant Control Unit					EEV		EEV				
Freezer Oil Capacity			cc	320		320					
Refrigerant to Change (R410A)			g	900		900					
Protection Device (OLP)					None		None				
Cooling Test Condition					Indoor Unit : DB27°C WB 19°C		Outdoor Unit : DB35°C WB 24°C				
Heating Test Condition					Indoor Unit : DB20°C WB 15°C		Outdoor Unit : DB7°C WB 6°C				
Operation conditon range	cooling	indoor		16°C ~ 32°C		16°C ~ 32°C					
		Outdoor		-10°C ~ 43°C		-10°C ~ 43°C					
	heating	indoor		-15°C ~ 30°C		-15°C ~ 30°C					
		Outdoor		-15°C ~ 24°C		-15°C ~ 24°C					

2-3 The Comparative Specifications of Product

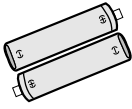
Item		Development Model	
		AQV09VBC	AQV12VBC
Design	Indoor Unit		
	Outdoor Unit		
Net Weight	Indoor Unit	9.0kg	9.0kg
	Outdoor Unit	32.6kg	32.6kg
Outer Dimension	Indoor Unit	825 x 285 x 189 (mm)	825 x 285 x 189 (mm)
	Outdoor Unit	790 x 548 x 285 (mm)	790 x 548 x 285 (mm)
Noise	Indoor Unit	41dB↓	43dB↓
	Outdoor Unit	51dB↓	53dB↓
Air Purifying System	Filter	Silver Nano Evaporator Anti-Allergy Filter Deodorizing Fiter	Silver Nano Evaporator Anti-Allergy Filter Deodorizing Fiter
	Micro Plasma Ion	MPI Mode	MPI Mode
Indoor Display		Digital I Display	Digital I Display

2-4 Accessory and Option Specifications

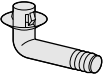
2-4-1 Accessories

Item	Descriptions	Code-No.	Q'TY	Remark
	Ass'y Plate Hanger	DB97-02851B	1	Indoor Unit
	Remote Control	DB93-04700P	1	
	Batteries for Remote Control	DB47-90024A	2	
	User's Manual	DB98-28491A	1	
	Installation Manual	DB98-28492A	1	
	3-wire Power Cable	DB93-01549F (Europe)	1	
	Drain Plug	DB67-20011A	1	Outdoor Unit
	Rubber Leg	DB73-00182A	4	

Accessories(cont.)

Item	Descriptions	Code-No.	Q'TY	Remark
	4-wire Assembly Cable	DB39-01092B	1	
	Assembly Pipe, ø6.35mm	DB96-10453B	1	
	Assembly Pipe, ø9.52mm	DB96-10453F	1	
	 PE T3 Foam Tube Insulation	DB72-50165A	1	Accessory Box
	Vinyl Tape, Width 50mm	DB72-00459A	1	
	Drain Plug	DB67-20011A	1	
	Rubber Leg	DB73-00182A	4	

Accessories(cont.)

Item	Descriptions	Code-No.	Q'TY	Remark
	Pipe Clamps A	DB39-20224A	3	
	Pipe Clamps B	DB39-20224B	3	
	Cement Nail	-	6	
	M4x16 Tapping Screws	6002-000215	10	Accessory Box
				
	Drain Hose, length 2m	DB62-00487A	1	
	Putty 100g	DB98-10568A	1	

3. Alignment and Adjustments

3-1 Test Mode

■ How to Approach Test Mode

You can approach the Test Mode by pressing the on/off switch of indoor unit for 5 seconds.

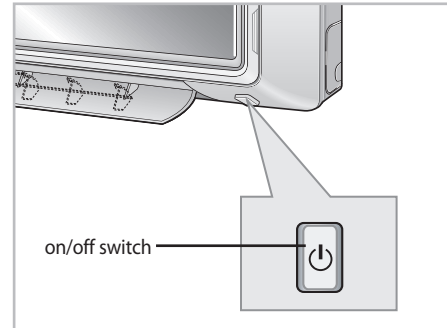

■ Test Mode Operation Option

After installing the air conditioner, check whether each subordinate is normally operated or not by operating the Test Mode.

- **When an error occurs, display the Error Mode.**
- **Operation Mode :** Cool mode. Operate the cool mode by operating the compressor by force without the compressor ON/OFF according to the set temperature/indoor temperature. (Do not follow the antifreeze control)
- **Up-down louver :** Up-down swing mode
- **Indoor Fan :** High



• Because the Test Mode operate the cool mode by force not related to the set temperature / indoor temperature, check whether each subordinate is operated normally or not after completing installation and must turn off the power of the air conditioner.

Air Marketing Group LLC

3-2 Indoor Display Error and Check Method

No	LED Display	Explanation	Explanation
1	E464	IPM Over Current(O.C)	
2	E461	Compressor Starting Error	
3	E473	Compressor Lock Error	
4	E466	DC-Link voltage under/over Error	
5	E221	Outdoor temperature sensor Error	
6	E416	Discharge over temperature	
7	E251	Discharge temperature sensor Error	
8	E468	Current sensor Error	
9	E465	Compressor Vlimit Error	
10	E237	Coil temperature sensor Error	
11	E202	1min. Time out Communication	
12	E458	Fan Error	
13	E471	OTP Error	
14	E467	Compressor Rotation Error	
15	E440/E441 (Low/High)	Operation condition secession	
16	E469	DC-Link valtage sensor Error	
17	E462	I_Trip error / PFC Over current	
18	E554	Gas Leak Error	
19	E472	AC Line Zero Cross Signal out	
20	E556	Capacity Miss-match	
21	E121	Room sensor Error	Open/Short
22	E122	In-coil sensor Error	Open/Short
23	E154	FAN Error	Indoor Fan Motor Abnormal Operation Holding for 15 sec. at less than 450rpm
24	E101	1min. Time out Communication	
25	E186	MPI Error	
26	All Lamps Blink	EEPROM Error	
27	All Lamps Blink	Option Error	Option Not Set up, Option Data Error

3-3 Outdoor LED Error Display and Check Method



No.	LED Display			Explanation
	Yellow	Green	Red	
1	○	○	○	Power off/VDD NG
2	○	○	◎	IPM Over Current(O.C)
3	○	○	●	Abnormal Serial communication
	○	●	●	
4	○	◎	○	Compressor Starting error
5	○	◎	●	Normal Operation
6	○	●	○	Compressor Lock error
7	○	●	◎	DC-Link voltage under/over error
8	◎	○	◎	Outdoor temperature sensor error
9	◎	○	●	Discharge over temperature
10	◎	◎	○	Discharge temperature sensor error
11	◎	◎	●	Current sensor error
12	◎	●	○	Compressor limit error
13	◎	●	◎	Coil temperature sensor error
14	◎	●	●	1min. Time out Communication
15	●	○	○	Fan error
16	●	○	◎	OTP error
17	●	○	●	Compressor rotation error
18	●	◎	◎	DC-Link voltage sensor error
19	●	◎	●	I_Trip error / PFC Over current
20	●	●	○	GAS Leak error
21	●	●	◎	AC Line Zero Cross Signal out
22	●	●	●	Power ON reset(1sec)
23	◎	○	○	Capacity miss match

● : LED ON, ○ : LED OFF, ◎ : LED BLINK

3-4 Setting Option Setup Method

ex) Option No. : 066064-170373

Step 1 : Enter the Option Setup mode.

- 1st Take out the batteries of remote control.
- 2nd Press the temperature  button simultaneously and insert the battery again.
- 3rd Make sure the remote display shown as 

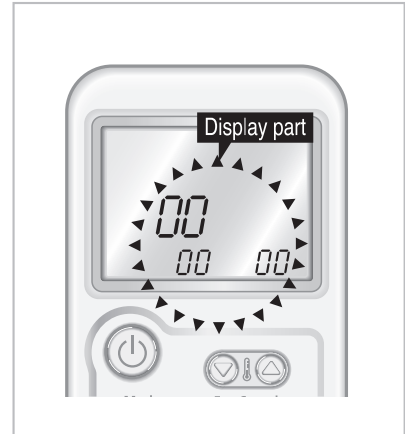



Step 2 : Enter the Option Setup mode and select your option according to the following procedure.



SAMSUNG

1

The default value is .
Otherwise, push the  button to .
Every time you push the button, the display panel reads 1 or 0 repeatedly.



2

Push the  button to set the display panel to .
Every time you push the button, the display panel reads 0 → 1 → 2 → 3 → ... 9 → A → b → c → d → E → F repeatedly.

3

Push the  button to set the display panel to .
Every time you push the button, the display panel reads 0 → 1 → 2 → 3 → ... 9 → A → b → c → d → E → F repeatedly.

4



Push the  button to set the display panel to .
Every time you push the button, the display panel reads 0 → 1 → 2 → 3 → ... 9 → A → b → c → d → E → F repeatedly.

5



Push the  button to set the display panel to .
Every time you push the button, the display panel reads 0 → 1 → 2 → 3 → ... 9 → A → b → c → d → E → F repeatedly.





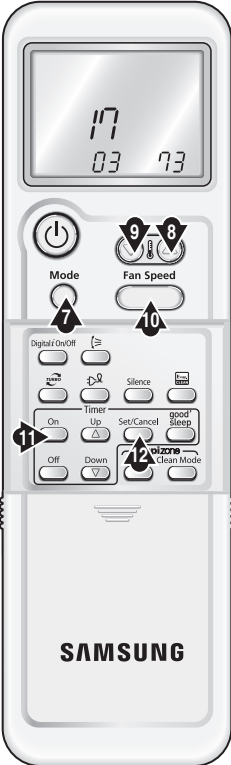







6













Push the  button to set the display panel to .
Every time you push the button, the display panel reads 0 → 1 → 2 → 3 → ... 9 → A → b → c → d → E → F repeatedly.













* Setting is not required if you must  a value which has a  default.





























7 Press  button, then the default value is .



8 Push the  button to set the display panel to .
Every time you push the button, the display panel reads  →  → 
→  → ... →  →  →  →  →  →  →  repeatedly.

9 Push the  button to set the display panel to .
Every time you push the button, the display panel reads  →  → 
→  → ... →  →  →  →  →  →  →  repeatedly.

10 Push the  button to set the display panel to .
Every time you push the button, the display panel reads  →  → 
→  → ... →  →  →  →  →  →  →  repeatedly.



11 Push the  button to set the display panel to .
Every time you push the button, the display panel reads  →  → 
→  → ... →  →  →  →  →  →  →  repeatedly.

12 Push the  button to set the display panel to .
Every time you push the button, the display panel reads  →  → 
→  → ... →  →  →  →  →  →  →  repeatedly.

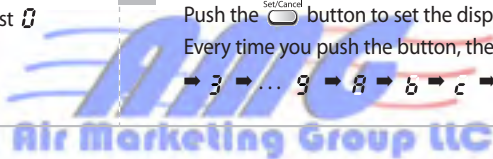

* Setting is not required if you must  a value which has a  default.



Step 3 : Upon completion of the selection, check you made right selections.

Press the Mode Selection key,  to set the display part to  and check the display part.

⇒ The display part shows .

Press the Mode Selection key,  to set the display part to  and check the display part.

⇒ The display part shows .

Step 4 : Pressing the ON/OFF button ()

When pressing the operation ON/OFF key with the direction of remote control for unit, the sound "Ding" or "Diring" is heard and the OPERATION ICON() lamp of the display is flickering at the same time, then the input of option is completed. (If the diring sound isn't heard, try again pressing the ON/OFF button.)

Step 5 : Unit operation test-run

First, Remove the battery from the remote control.

Second, Re-insert the battery into the remote control.

Third, Press ON/OFF key with the direction of remote control for set.

• Error Mode

- 1st If all lamps of indoor unit are flickering, Plug out, plug in power plug again and press ON/OFF key to retry.
- 2nd If the unit is not working properly or all lamps are continuously flickering after setting the option code, see if the correct option code is set up for its model.



■ OPTION ITEMS

REMOCON MODEL	SEG1	SEG2	SEG3	SEG4	SEG5	SEG6	SEG7	SEG8	SEG9	SEG10	SEG11	SEG12
AQV09VBCN	0	4	4	7	7	7	1	7	5	2	0	C
AQV12VBCN	0	5	4	7	7	7	1	7	5	2	1	D







4. Disassembly and Reassembly





■ Necessary Tools

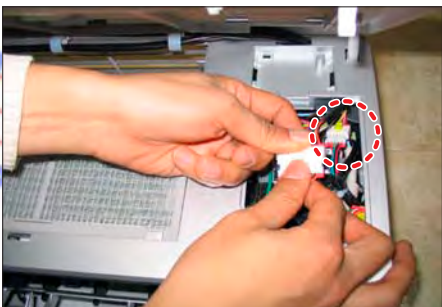



Item	Remark
+SCREW DRIVER	
MONKEY SPANNER	

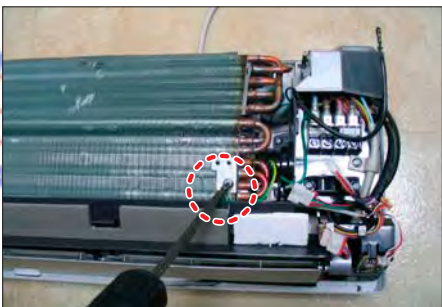
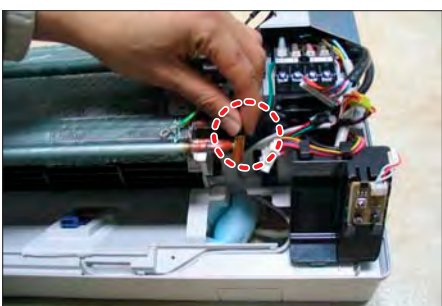

4-1 Indoor Unit

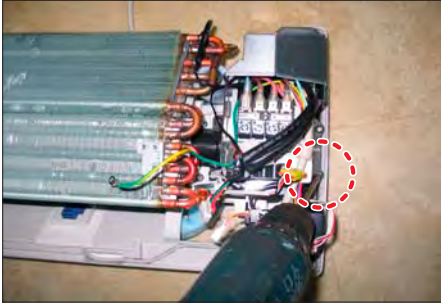
No	Parts	Procedure	Remark
1	PANEL-FRONT	<p>1) Stop the driving of air conditioner and shut off main power supply.</p> <p>2) Please open the front grille.</p> <p>3) Please detach link grilles from main frame.</p> <p>4) To detach front grille from main frame, please catches finger stop</p> <p>5) Please loosen clamping screw and detach the terminal cover.</p> <p>6) Please take out filter to downward.</p>	    

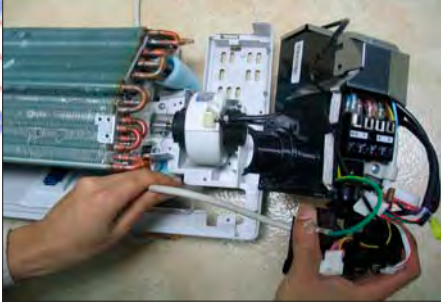
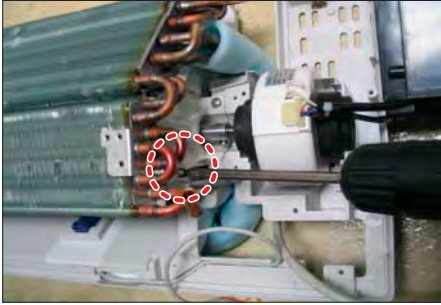
No	Parts	Procedure	Remark
		<p>7) Please detach the cover screw 3EA from the bottom of the panel front.</p> <p>8) Loosen screws 3EA at the bottom of panel front and 2EA at the front of the panel front.</p> <p>9) Loosen the screw of the ASSY DISPLAY.</p> <p>10) Please separate Linked connector from the assy display.</p> <p>11) Unlock 2 hooks between panel front and try drain to separate panel front.</p>	    

No	Parts	Procedure	Remark
		12)Unlock 2 hooks between panel front and back body.	
2	TRAY DRAIN	1) Please detach stepping motor wire. 2) Please pull tray drain and separate from back body.	
3	evap	1) Loosen the ground wire screw.  2) Detach the temperature sensor. 3) Detach the holder pipe.	  

No	Parts	Procedure	Remark
		<p>4) Loosen 3 EA screws, left of holder evap.</p> <p>5) Loosen 1EA screw, right of holder motor.</p> <p>6) Detach the heat exchanger from indoor unit.</p>	  
4	MAIN PCB	<p>1) Loosen 4EA screws of holder.</p> <p>2) Detach Link wires of indoor, outdoor unit and fan motor.</p> <p>3) Detach assy control from indoor unit.</p>	 

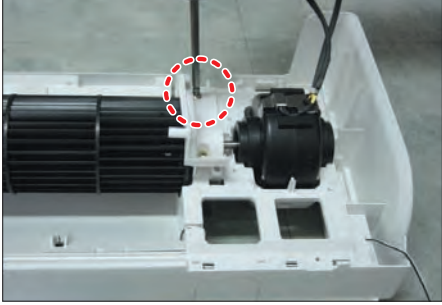
No	Parts	Procedure	Remark
5	Fan Motor & Cross Fan	<ol style="list-style-type: none"> 1) Loosen 2EA screws of holder motor and Detach the holder. 2) Loosen a screw and detach the cross fan. 3) Detach the holder bearing and motor. 	





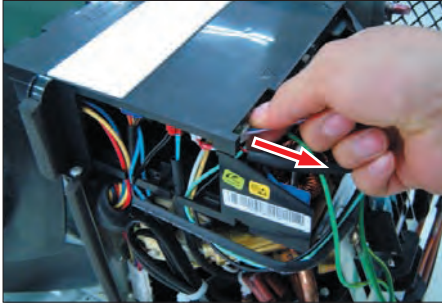
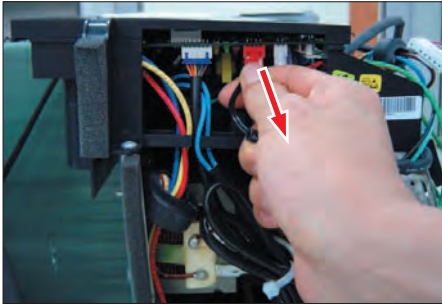
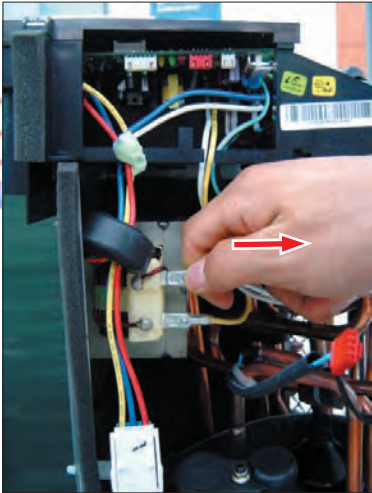
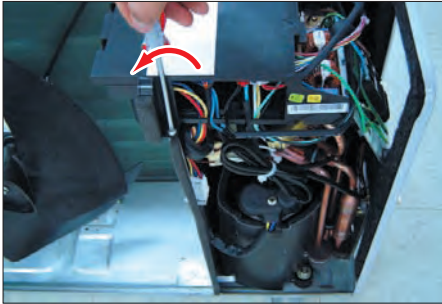

4-2 Outdoor Unit

No	Parts	Procedure	Remark
1	Common Work	<p>1) Loosen 1 fixing screw(CCW) of the Cover-Side. (Use +Screw Driver.)</p> <p>2) Loosen each 4 screws(CCW) on both right and left Cabinet Side edges and a fixing screw on the Cabinet Front lower to detach the Cabinet Front. (Use +Screw Driver.)</p> <p>3) Detach the Cabinet Front like the picture on the right side.</p> <p>4) Loosen 1 screw(CCW) fixed to assemble Plate Control Out with Cabinet-Side RH. (Use +Screw Driver.)</p>	   

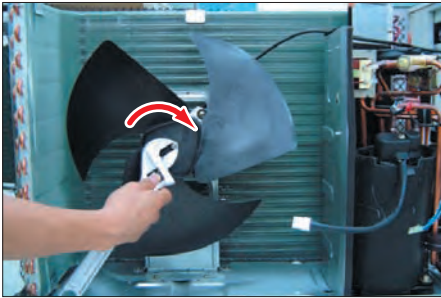
No	Parts	Procedure	Remark
		<p>5) Loosen 2 fixing screws(CCW) on the rear side of Cabinet-Side RH. (Use +Screw Driver.)</p> <p>6) Loosen 3 screws(CCW) fixed to assemble Bracket Valve with Cabinet-Side RH. (Use +Screw Driver.)</p> <p>7) Loosen 2 fixing screws(CCW) of Cabinet Side LF. (Use +Screw Driver.)</p>	  

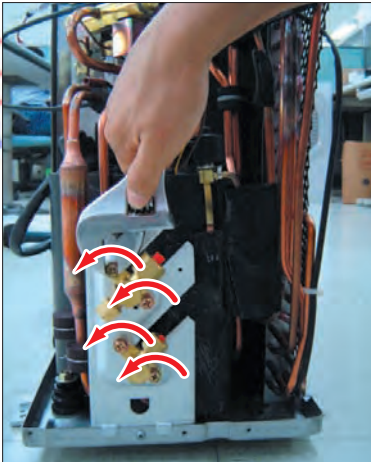
No	Parts	Procedure	Remark
2	Ass'y Control Out	<p>1) Detach the Motor Wire from the PCB of Ass'y Control Out.</p> <p>2) Detach several connectors from the PCB of Ass'y Control Out.</p> <p>3) Detach 2 Connect Wires from Reactor.</p>  <p>4) Loosen 1 screw(CCW) fixed to assemble Ass'y Control Out with Partition. (Use +Screw Driver.)</p>	   

No	Parts	Procedure	Remark
3	Fan & Motor	<ol style="list-style-type: none"> 1) Release the refrigerant at first. 2) Loosen fixing screw(CW). (Use Monkey Spanner.) 3) Disassemble the pipes in both inlet and outlet with welding torch. 4) Detach the Heat Exchanger. 	
4	Heat Exchanger	<ol style="list-style-type: none"> 1) Loosen 2 fixing screws(CCW) on both sides. (Use +Screw Driver.) 2) Disassemble the pipes in both inlet and outlet with welding torch. 3) Detach the Heat Exchanger. <p>⚠ Before you disassemble the pipes and Condenser, be sure that there should be no refrigerant remained in the unit.</p>	
5	Ass'y Valve 4-Way & Ass'y Valve EEV	<ol style="list-style-type: none"> 1) Loosen 4 bolts(CCW) fixed to assemble Valve Service with Bracket Valve like the picture on the right side. (Use Monkey Spanner.) 2) Disassemble the pipes assembled the suction and discharge sides of the Compressor with welding torch. 	
6	Compressor	<ol style="list-style-type: none"> 1) Loosen the Nut(CCW) of Terminal Cover. (Use Monkey Spanner.) 2) Detach the Terminal Cover and detach the Connect Comp Wire from Compressor. 3) Disassemble the Felt Comp Sound. 4) Loosen the 3 bolts(CCW) at the bottom of Compressor like the picture on the right side. (Use Monkey Spanner.) 	

MEMO



5. Exploded Views and Parts List

5-1 Indoor Unit

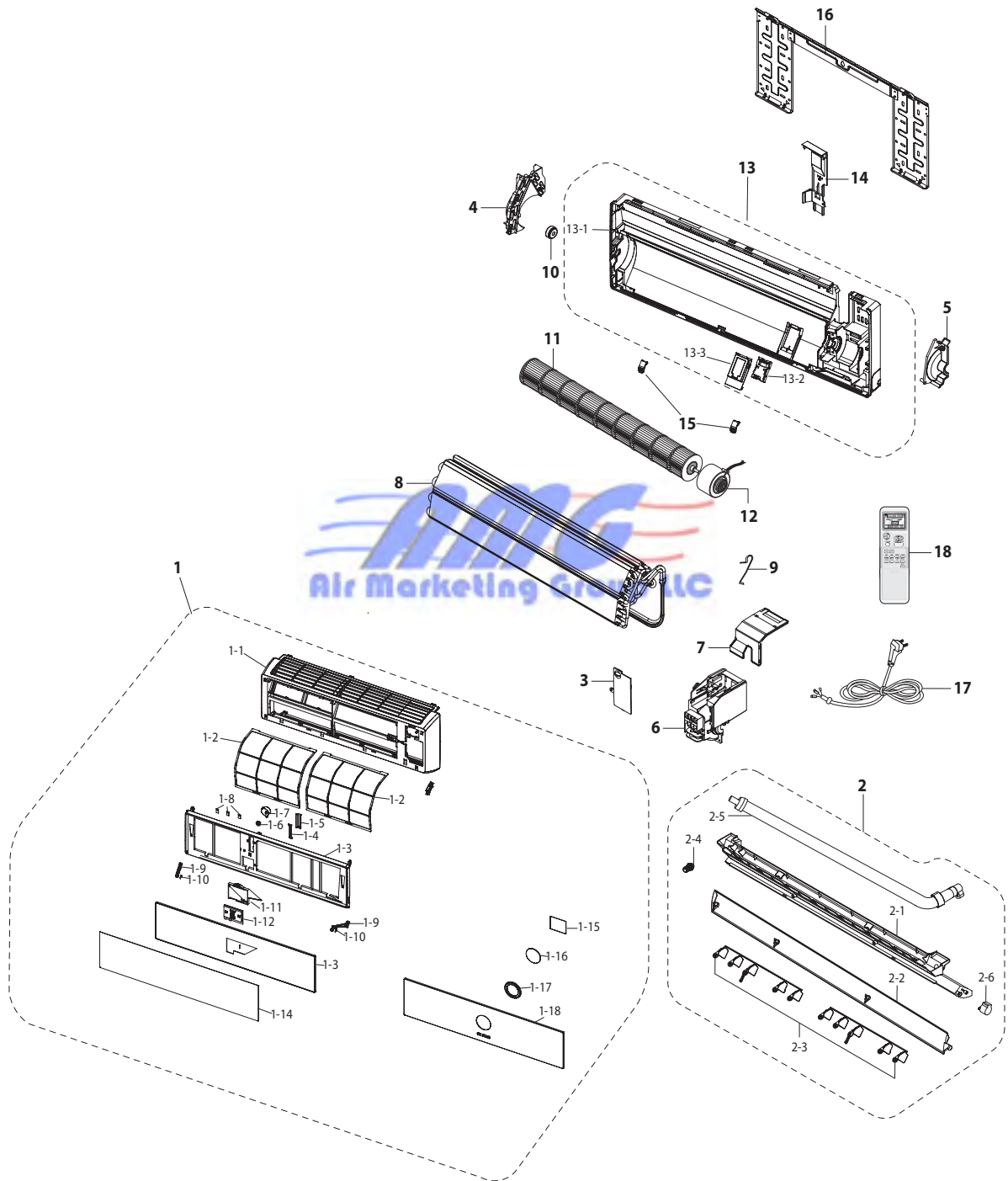

■ Parts List

No.	Code No.	Description	Specification	Q'TY		SA/SNA
				AQV09VBCN	AQV12VBCN	
1	DB92-01087H	ASSY PANEL FRONT	ASS'Y	1	1	SA
1-1	DB64-01633A	PANEL FRONT	HIPS	1	1	SA
1-2	DB63-01593B	FILTER PRE	PP	1	1	SA
1-3	DB64-01634B	PANEL MID	HIPS	1	1	SNA
1-4	DB66-01152A	LINK GRILLE	POM	1	1	SNA
1-5	DB66-01156A	GEAR RACK	POM	1	1	SNA
1-6	DB66-01155A	GEAR PINION	POM	1	1	SNA
1-7	DB31-00369B	ASSY MOTOR STEPPING	220-240V~, 50/60Hz, Class E	1	1	SA
1-8	DB61-03156A	HOLDER WIRE	PC	3	3	SNA
1-9	DB66-01176A	LINK SUPPORT	POM	4	4	SNA
1-10	DB61-03139A	SPRING GRILLE	STS304	2	2	SNA
1-11	DB63-01630A	COVER DISPLAY	ABS	1	1	SNA
1-12	DB93-04452F	ASSY DISPLAY	ASS'Y	1	1	SA
1-13	DB61-02910A	FRAME GRILLE	HIPS	1	1	SA
1-14	DB64-02054B	WINDOW MIRROR	ACRYL	1	1	SA
2	DB94-01237A	ASSY TRAY DRAIN	ASS'Y	1	1	SA
2-1	DB63-01578A	TRAY DRAIN	ABS	1	1	SNA
2-2	DB61-02908A	BLADE H	HIPS	1	1	SA
2-3	DB61-01636A	BLADE V	PP	2	2	SA
2-4	DB73-00180A	RUBBER CAP DRAIN	GUM-EPM	1	1	SNA
2-5	DB94-00458B	ASSY DRAIN HOSE	ASS'Y	1	1	SA
2-6	DB31-00371A	MOTOR STEP	220-240V~, 50/60Hz, Class E	1	1	SA
3	DB63-00844D	COVER TERMINAL	ABS V0	1	1	SA
4	DB63-00850A	COVER BEARING	ABS	1	1	SNA
5	DB96-03149A	ASSY EVAP SUPPORT	ASS'Y	1	1	SA
6	DB93-05854A	ASSY CONTROL IN	ASS'Y	1	1	SA
7	DB90-02082A	ASSY COVER PCB	ASS'Y	1	1	SNA
8	DB96-09549A	ASSY EVAP TOTAL	ASS'Y	1	1	SNA
9	DB67-60030A	SPRING SENSOR	STS304	1	1	SNA
10	DB94-00455A	ASSY BEARING RUBBER	ASS'Y	1	1	SNA
11	DB94-00456A	ASSY CROSS FAN	ASS'Y	1	1	SA
12	DB31-00219A	MOTOR FAN IN	220-240V~, 50/60Hz, Class E	1	1	SA
13	DB94-01152B	ASSY BODY BACK	ASS'Y	1	1	SA
13-1	DB61-03028A	BODY BACK	HIPS	1	1	SNA
13-2	DB93-04230A	ASSY COMPACT MPI	ASS'Y	1	1	SA
13-3	DB63-01583A	COVER MPI	HIPS	1	1	SNA
14	DB61-01638B	HOLDER PIPE	HIPS	1	1	SNA
15	DB67-00499C	CAP SCREW	HIPS	2	2	SNA
16	DB70-00534A	PLATE HANGER	SGCC-M	1	1	SNA
18	DB93-04700P	ASSY REMOCON	ARH-1346	1	1	SNA

5-2 Outdoor Unit

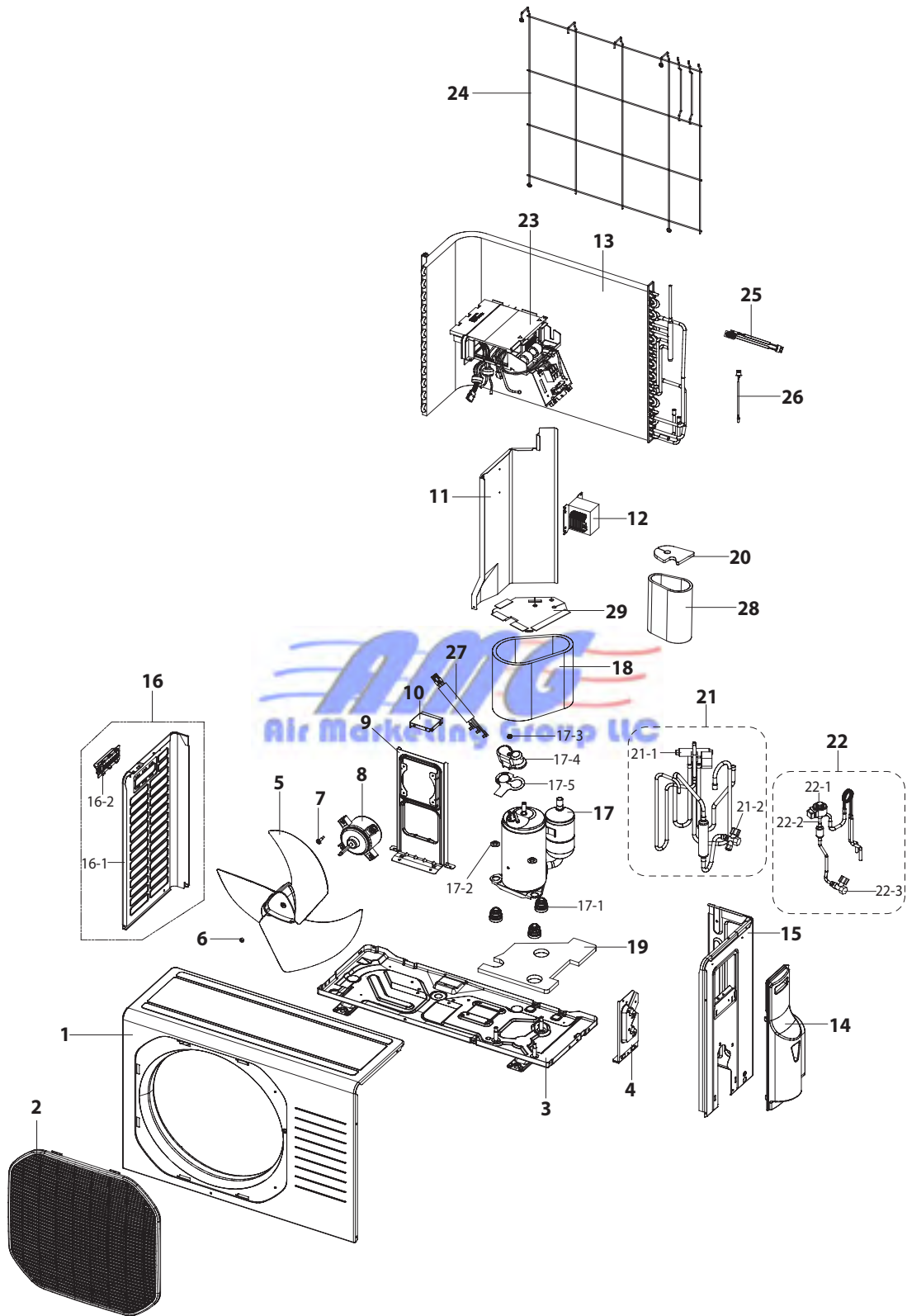

■ Parts List

No.	Code No.	Description	Specification	Q'TY		SA/SNA
				AQV09VBCX	AQV12VBCX	
1	DB90-01711F	ASS'Y CABI FRONT	ASS'Y, SC-94445T	1	1	SA
2	DB63-00847A	GUARD FAN	HIPS, SC-90073R	1	1	SA
3	DB90-01681E	ASS'Y BASE OUT	ASS'Y, SC-94445T	1	1	SA
4	DB61-02068B	ASS'Y BRACKET VALVE	ASS'Y, SC-94445T	1	1	SA
5	DB67-00397A	FAN-PROPELLER	AS+G/F20%, Ø400	1	1	SA
6	DB60-30004A	SCREW MACHINE	M6	1	1	SA
7	DB60-00150A	SCREW SPECIAL	M4	4	4	SNA
8	DB31-00431A	MOTOR FAN OUT	BLDC Motor, SIC-52FV-F726-2	1	1	SA
9	DB61-01644A	BRACKET MOTOR	SGCC-M	1	1	SA
10	DB97-02225D	ASS'Y SUPPORT PLATE B/M	SGCC-M	1	1	SA
11	DB94-01655A	ASS'Y PARTITION	ASS'Y, SGCC-M	1	1	SA
12	DB27-00041A	REACTOR	PPS,5mH, 10A	1	1	SA
13	DB96-08373A	ASS'Y COND UNIT	ASS'Y	1	1	SA
14	DB63-01996A	COVER VALVE	PP, SC-90073R	1	1	SA
15	DB90-02876C	ASS'Y CABINET SIDE RH	ASS'Y, SC-94445T	1	1	SA
16	DB90-01713A	ASS'Y CABINET SIDE LF	ASS'Y, SC-94445T	1	1	SA
16-1	DB64-00982A	CABINET SIDE LF	SECC-P, SC-94445T	1	1	SA
16-2	DB64-00992A	HANDLE LF	PP	1	1	SA
17	G4C090LUDER	COMPRESSOR	ROTARY, BLDC	1	1	SNA
17-1	DB99-00987A	ASST GROMMET	NR	3	3	SNA
17-2	DB60-30028A	SCREW HEX	M8	3	3	SNA
17-3	DB60-30018A	SCREW MACHINE	M5	1	1	SNA
17-4	DB63-00489A	COVER TERMINAL	PBT (G/F 15%)	1	1	SNA
17-5	DB63-00817A	GASKET	EPDM	1	1	SNA
18	DB63-01647A	FELT COMP SIDE	FELT+PVC Sheet	1	1	SA
19	DB63-01958A	FELT COMP BASE	FELT+PVC Sheet	1	1	SA
20	DB63-01710B	FELT COMP UPPER	FELT+PVC Sheet	1	1	SA
21	DB96-08389A	ASS'Y VALVE 4WAY	ASS'Y	1	1	SA
21-1	DB62-02286A	4WAY VALVE	R410A, SANHUA	1	1	SNA
21-2	DB62-02284A	VALVE SERVICE	R410A, SANHUA, 3/8"	1	1	SNA
22	DB96-08390A	ASS'Y VALVE EEV	ASS'Y	1	1	SA
22-1	DB62-03964A	VALVE EXPANSION COIL	FUJIKOKI, Ø1.4	1	1	SNA
22-2	DB62-03916A	VALVE EXPANSION BODY	FUJIKOKI, Ø1.4	1	1	SNA
22-3	DB62-02283A	VALVE SERVICE	R410A, SANHUA, 1/4"	1	1	SNA
23	DB93-05534E	ASS'Y CONTROL OUT	ASS'Y	-	1	SA
	DB93-05534F	ASS'Y CONTROL OUT	ASS'Y	1	-	SA
24	DB64-02028A	SCREEN COND BAR	P.E.H 100%	1	1	SA
25	DB32-00176D	THERMISTOR OUT/DIS	ASS'Y	1	1	SA
26	DB32-00121B	THERMISTOR COND	ASS'Y	1	1	SA
27	DB93-04489A	CONNECT WIRE COMP	ASS'Y	1	1	SA
28	DB63-01934A	FELT COMP SIDE OUT	ASS'Y	1	1	SA
29	DB63-02034A	FELT COMP UPPER OUT	ASS'Y	1	1	SA

5-3 Ass'y Control In : B93-05854A

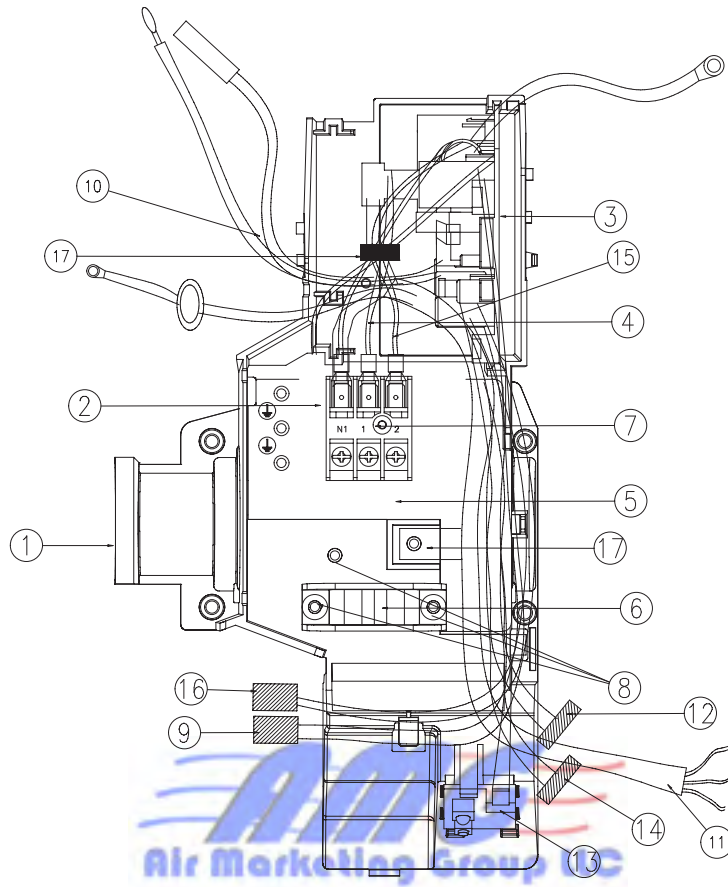

■ Parts List

No.	Code No.	Description	Specification	Q'ty	SN/SNA
1	DB61-02907A	CASE-CONTROL IN	ABS	1	SA
2	DB95-01140B	TERMINAL BLOCK	DAF-3P	1	SNA
3	DB93-05619B	ASSY-PCB IN MAIN	VIVACE,9K/12K	1	SA
4	DB93-06153A	CONNECT WIRE-T/B(1)	LEAD WIRE	1	SNA
5	DB61-01639A	PLATE-CONTROL IN	SGCC-M 1.2	1	SNA
6	DB61-01097A	HOLDER-WIRE CLAMP	ABS	1	SA
7	6001-000929	SCREW	PH+,M3,L22	1	SNA
8	6001-001054	SCREW	TH,+M4,L10	3	SNA
9	DB93-04487A	CONNECT WIRE	STEP MOTOR	1	SNA
10	DB95-01113A	SENSOR	4P(103AT)	1	SA
11	DB91-00434A	ASSY POWER CORE	H05VV-F 3*1.0, Core	1	SNA
12	DB93-04622A	CONNECT WIRE	DISPLAY	1	SNA
13	DB93-04430A	ASSY MODULE PCB	MODULE	1	SNA
14	DB93-04484A	CONNECT WIRE	STEP MOTOR, GRILL	1	SNA
15	DB93-04367A	CONNECT WIRE	POWER	1	SNA
16	DB93-04695A	CONNECT WIRE MPI	ASSY	1	SNA
17	6001-000725	SCREW-MACHINE	TH M4*L16	1	SNA

MEMO



5-4 Ass'y Control Out

- Aqv09VBCX : DB93-05534E
- Aqv12VBCX : DB93-05534F

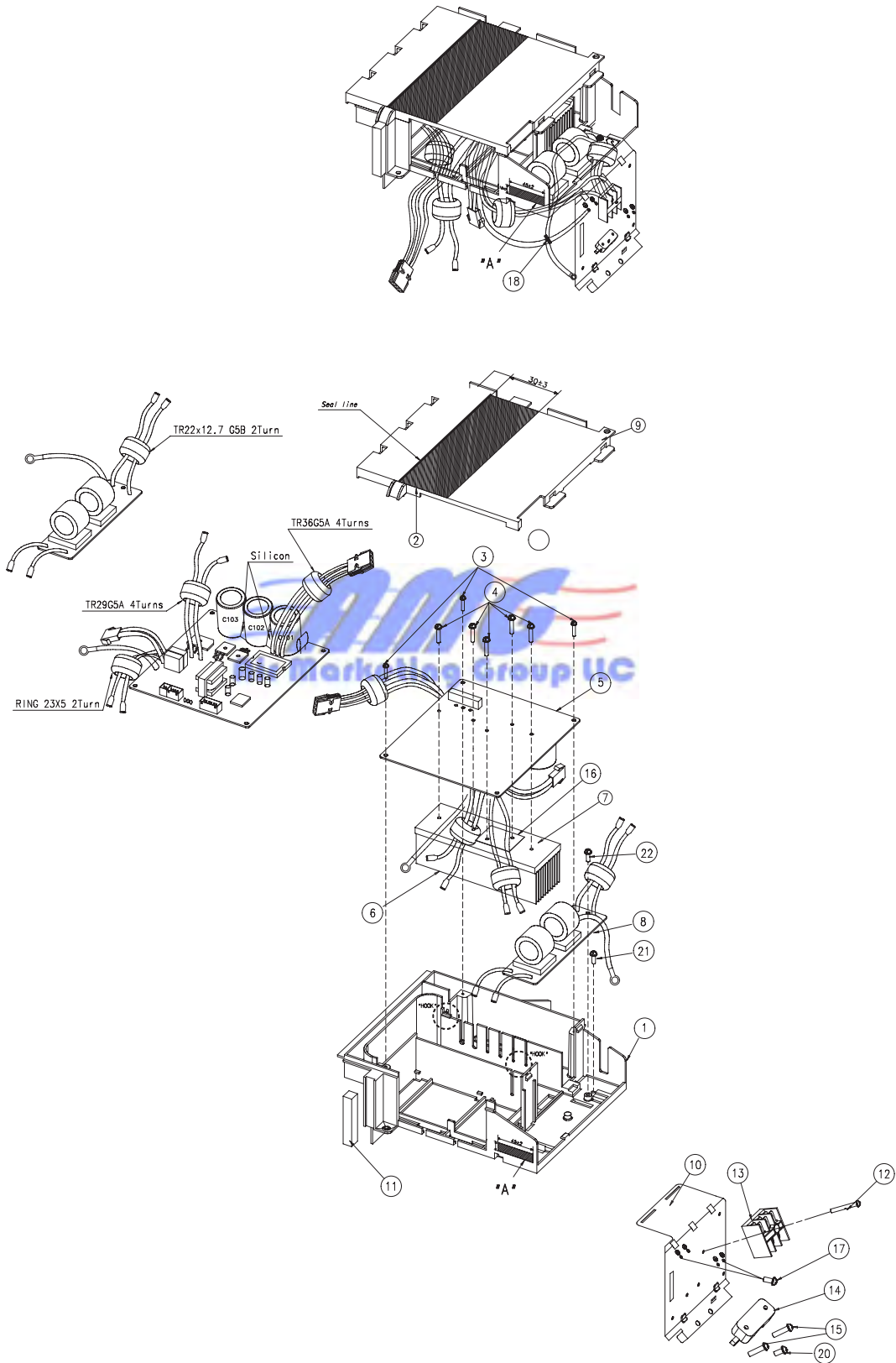

■ Parts List

No	CODE NO.	DESCRIPTION	SPECIFICATION	**09**	**12**	SA/SNA
				DB93-05534E	DB93-05534F	
1	DB61-02250A	CASE CONTROL-BASE	CASE CONTROL COVER	1	1	SA
2	DB62-04566A	SEAL-CASE CONTROL COVER	SEAL-CASE CONTROL COVER	1	1	SNA
3	6002-000630	SCREW	PH +,2S,M3,L8	3	3	SNA
4	DB91-00306A	ASSY-SCREW MACHINE	SCREW,M3,L16	5	5	SNA
5	DB93-05543F	ASSY-PCB OUT	ASSY-PCB OUT,VIVACE 12K	-	1	SA
1	DB93-05543E	ASSY-PCB OUT	ASSY-PCB OUT,VIVACE 9K	1	-	SA
6	DB62-03155A	HEAT SINK	HEAT SINK	1	1	SA
7	DB98-24813A	ASSY	THERMAL GREASE	0.002	0.002	SNA
8	DB93-04264A	ASSY-PCB EMI	ASSY PCB-OUTDOOR	1	1	SA
9	DB61-02249A	CASE CONTROL-COVER	CASE CONTROL BASE	1	1	SA
10	DB70-00858A	PLATE-CONTROL OUT	PLATE-CONTROL OUT	1	1	SNA
11	DB62-02332P	SEAL-CASE CONTROL	FOAM-PU(30)	1	1	SNA
12	DB91-00309A	SCREW-TAPPING	PH+,M3,20	1	1	SNA
13	DB95-01140B	TERMINAL BLOCK	TERMINAL BLOCK-ASSY	1	1	SNA
14	DB61-00250A	HOLDER-WIRE CLAMP	HOLDER-WIRE CLAMP	1	1	SNA
15	6002-000234	SCREW	TH +,M4,L10	2	2	SNA
16	DB81-00547B	INSULATOR-KFR	MICA	1	1	SNA
17	6009-001001	SCREW	TH+,M4,L8	2	2	SNA
18	DB65-10088D	CABLE-TIE	NYLON66	1	1	SNA
19	2301-001377	C-FILM,LEAD-OTHER	1.2uF,450V	0	0	SNA
20	6003-000336	SCREW	TH,+,-,M4,L10,ZPC,SM20C,-,-	1	1	SNA
21	6002-000560	SCREW-TAPPING	PH+,M4,2S,L10	0	0	SNA
22	6002-000630	SCREW	PH +,2S,M3,L8	1	1	SNA

6. Electrical Parts List

■ MAIN PCB : DB93-05619B

Location No.	Code No.	Description	Specification	Q'ty	SA/SNA
D701	0402-000012	DIODE-RECTIFIER	UF4007,1KV,1A,DO-41,TP	1	SNA
BD71	0402-001298	DIODE-BRIDGE	DF06S,600V,1A,SMD-4,TP	1	SNA
D101	0402-001427	DIODE-RECTIFIER	ES1D,200V,1A,DO-214AC,TP	1	SNA
ZD11	0403-000252	DIODE-ZENER	BZX84C3V6,3.4-3.8V,350MW,SOT-23,TP	1	SNA
ZD13	0403-000466	DIODE-ZENER	BZX84C4V3,4.3,225mW,SOT-23,TP	1	SNA
ZD12	0403-001285	DIODE-ZENER	BZX84-C11,10.4-11.6V,350mW,SOT-23,TP	1	SNA
CD11	0406-001086	DIODE-TVS	ST02D-200,185/200/215V,200W,DO-214	1	SNA
Q201	0501-000534	TR-SMALL SIGNAL	2SC2412K,NPN,200mW,SOT-23,TP,180-390	1	SNA
Q401	0501-000534	TR-SMALL SIGNAL	2SC2412K,NPN,200mW,SOT-23,TP,180-390	1	SNA
Q601	0501-000534	TR-SMALL SIGNAL	2SC2412K,NPN,200mW,SOT-23,TP,180-390	1	SNA
Q603	0501-000534	TR-SMALL SIGNAL	2SC2412K,NPN,200mW,SOT-23,TP,180-390	1	SNA
Q602	0501-002296	TR-SMALL SIGNAL	MMST2907A,PNP,200MW,SMT3,TP,100-300	1	SNA
Q101	0504-001064	TR-DIGITAL	DTC114EKA,NPN,200mW,10K/10K,SOT-23,TP	1	SNA
IC05	0506-000175	TR-ARRAY	2003,NPN,7,1W,SOP-16,ST,1000	1	SNA
IC06	0506-000175	TR-ARRAY	2003,NPN,7,1W,SOP-16,ST,1000	1	SNA
IC08	0506-000175	TR-ARRAY	2003,NPN,7,1W,SOP-16,ST,1000	1	SNA
PC02	0604-001003	PHOTO-COUPLER	TR,50-150%,200mW,DIP-4,ST	1	SNA
PC01	0604-001038	PHOTO-COUPLER	TR,130-260%,200mW,DIP-4,ST	1	SNA
IC07	1003-001462	IC-SOURCE DRIVER	TD62783AFW,SOL,18P,-,8,-500MA,TP,PLASTIC,50V,-40TO85C,1.47,50V,-	1	SNA
IC09	1103-001175	IC-EEPROM	93LC56,128x16,SOP,8P,5x4mm,2.5/6.0V,-40to+85C	1	SNA
IC02	1203-000429	IC-POSI.FIXED REG.	78L05A,TO-92,3P,-,PLASTIC,4.6/	1	SNA
IC01	1203-002545	IC-PWM CONTROLLER	266,DIP,8P,300MIL,PLASTIC,-0.3/700V,-,40TO+150C,560MA,-,ST	1	SNA
IC59	1203-003334	IC-RESET	S-801,SOT-23,5P,2.9x1.6mm,PLASTIC,3.716/4.284V,256mW,-,2.5mA,-,TP	1	SNA
VA71	1405-000154	VARISTOR	460Vdc,2500A,17.5x7.5mm,TP	1	SNA
R103	2002-001104	R-COMPOSITION	12Mohm,5%,1/2W,AA,TP,3.4x9mm	1	SNA
R104	2002-001104	R-COMPOSITION	12Mohm,5%,1/2W,AA,TP,3.4x9mm	1	SNA
R701	2006-001080	R-CEMENT(S)	200ohm,5%,5W,CB,BK,13x9x25.5mm	1	SNA
R505	2007-000070	R-CHIP	0ohm,5%,1/10W,TP,1608	1	SNA
R405	2007-000076	R-CHIP	330ohm,5%,1/10W,TP,1608	1	SNA
R406	2007-000076	R-CHIP	330ohm,5%,1/10W,TP,1608	1	SNA
R412	2007-000076	R-CHIP	330ohm,5%,1/10W,TP,1608	1	SNA
R607	2007-000077	R-CHIP	470ohm,5%,1/10W,TP,1608	1	SNA
R608	2007-000077	R-CHIP	470ohm,5%,1/10W,TP,1608	1	SNA
R210	2007-000078	R-CHIP	1Kohm,5%,1/10W,TP,1608	1	SNA
R211	2007-000078	R-CHIP	1Kohm,5%,1/10W,TP,1608	1	SNA
R401	2007-000078	R-CHIP	1Kohm,5%,1/10W,TP,1608	1	SNA
R402	2007-000078	R-CHIP	1Kohm,5%,1/10W,TP,1608	1	SNA
R404	2007-000078	R-CHIP	1Kohm,5%,1/10W,TP,1608	1	SNA
R409	2007-000078	R-CHIP	1Kohm,5%,1/10W,TP,1608	1	SNA
R503	2007-000078	R-CHIP	1Kohm,5%,1/10W,TP,1608	1	SNA
R602	2007-000078	R-CHIP	1Kohm,5%,1/10W,TP,1608	1	SNA
R604	2007-000078	R-CHIP	1Kohm,5%,1/10W,TP,1608	1	SNA
R610	2007-000078	R-CHIP	1Kohm,5%,1/10W,TP,1608	1	SNA

■ MAIN PCB : DB93-05619B(cont.)

Location No.	Code No.	Description	Specification	Q'ty	SA/SNA
R611	2007-000078	R-CHIP	1Kohm,5%,1/10W,TP,1608	1	SNA
R606	2007-000084	R-CHIP	4.7Kohm,5%,1/10W,TP,1608	1	SNA
R909	2007-000084	R-CHIP	4.7Kohm,5%,1/10W,TP,1608	1	SNA
R403	2007-000087	R-CHIP	6.8Kohm,5%,1/10W,TP,1608	1	SNA
R802	2007-000087	R-CHIP	6.8Kohm,5%,1/10W,TP,1608	1	SNA
R209	2007-000090	R-CHIP	10Kohm,5%,1/10W,TP,1608	1	SNA
R301	2007-000090	R-CHIP	10Kohm,5%,1/10W,TP,1608	1	SNA
R605	2007-000090	R-CHIP	10Kohm,5%,1/10W,TP,1608	1	SNA
R801	2007-000090	R-CHIP	10Kohm,5%,1/10W,TP,1608	1	SNA
R908	2007-000090	R-CHIP	10Kohm,5%,1/10W,TP,1608	1	SNA
R502	2007-000093	R-CHIP	20Kohm,5%,1/10W,TP,1608	1	SNA
R410	2007-000109	R-CHIP	1Mohm,5%,1/10W,TP,1608	1	SNA
R501	2007-000109	R-CHIP	1Mohm,5%,1/10W,TP,1608	1	SNA
R609	2007-000119	R-CHIP	560ohm,5%,1/10W,TP,1608	1	SNA
R101	2007-000290	R-CHIP	100ohm,5%,1/8W,TP,2012	1	SNA
R102	2007-000493	R-CHIP	2.2Kohm,5%,1/8W,TP,2012	1	SNA
R106	2007-000872	R-CHIP	4.7Kohm,5%,1/8W,TP,2012	1	SNA
R105	2007-000931	R-CHIP	470ohm,5%,1/8W,TP,2012	1	SNA
R201	2007-000944	R-CHIP	47Kohm,5%,1/4W,TP,3216	1	SNA
R202	2007-000944	R-CHIP	47Kohm,5%,1/4W,TP,3216	1	SNA
R203	2007-000944	R-CHIP	47Kohm,5%,1/4W,TP,3216	1	SNA
R204	2007-000944	R-CHIP	47Kohm,5%,1/4W,TP,3216	1	SNA
R205	2007-000944	R-CHIP	47Kohm,5%,1/4W,TP,3216	1	SNA
R206	2007-000944	R-CHIP	47Kohm,5%,1/4W,TP,3216	1	SNA
R207	2007-000944	R-CHIP	47Kohm,5%,1/4W,TP,3216	1	SNA
R208	2007-000944	R-CHIP	47Kohm,5%,1/4W,TP,3216	1	SNA
R504	2007-000962	R-CHIP	5.1Kohm,1%,1/10W,TP,1608	1	SNA
R407	2007-001068	R-CHIP	6.8Kohm,1%,1/10W,TP,1608	1	SNA
R408	2007-001068	R-CHIP	6.8Kohm,1%,1/10W,TP,1608	1	SNA
R411	2007-001068	R-CHIP	6.8Kohm,1%,1/10W,TP,1608	1	SNA
C110	2201-000983	C-CERAMIC,DISC	1NF,10%,2KV,Y5P,TP,9X5MM,7.5	1	SNA
C107	2201-000987	C-CERAMIC,DISC	2.2NF,20%,400V,Y5U,BK,12.5X6MM,10	1	SNA
C108	2201-000987	C-CERAMIC,DISC	2.2NF,20%,400V,Y5U,BK,12.5X6MM,10	1	SNA
C109	2201-002193	C-CERAMIC,DISC	0.082nF,±10%,3000V,SL,-,8.5 X 3,5	1	SNA
C502	2203-000189	C-CER,CHIP	100nF,+80-20%,25V,Y5V,1608	1	SNA
C503	2203-000189	C-CER,CHIP	100nF,+80-20%,25V,Y5V,1608	1	SNA
C504	2203-000189	C-CER,CHIP	100nF,+80-20%,25V,Y5V,1608	1	SNA
C505	2203-000189	C-CER,CHIP	100nF,+80-20%,25V,Y5V,1608	1	SNA
C506	2203-000189	C-CER,CHIP	100nF,+80-20%,25V,Y5V,1608	1	SNA
C507	2203-000189	C-CER,CHIP	100nF,+80-20%,25V,Y5V,1608	1	SNA
C508	2203-000189	C-CER,CHIP	100nF,+80-20%,25V,Y5V,1608	1	SNA
C509	2203-000189	C-CER,CHIP	100nF,+80-20%,25V,Y5V,1608	1	SNA
C510	2203-000189	C-CER,CHIP	100nF,+80-20%,25V,Y5V,1608	1	SNA
C102	2203-000192	C-CER,CHIP	100nF,+80-20%,50V,Y5V,2012	1	SNA
C201	2203-000192	C-CER,CHIP	100nF,+80-20%,50V,Y5V,2012	1	SNA

■ MAIN PCB : DB93-05619B(cont.)

Location No.	Code No.	Description	Specification	Q'ty	SA/SNA
C202	2203-000257	C-CER,CHIP	10nF,10%,50V,X7R,1608	1	SNA
C203	2203-000257	C-CER,CHIP	10nF,10%,50V,X7R,1608	1	SNA
C404	2203-000257	C-CER,CHIP	10nF,10%,50V,X7R,1608	1	SNA
C401	2203-000440	C-CER,CHIP	1nF,10%,50V,X7R,1608	1	SNA
C405	2203-000440	C-CER,CHIP	1nF,10%,50V,X7R,1608	1	SNA
C406	2203-000440	C-CER,CHIP	1nF,10%,50V,X7R,1608	1	SNA
C104	2203-005249	C-CER,CHIP	100nF,10%,50V,X7R,1608	1	SNA
C106	2203-005249	C-CER,CHIP	100nF,10%,50V,X7R,1608	1	SNA
C402	2203-005249	C-CER,CHIP	100nF,10%,50V,X7R,1608	1	SNA
C403	2203-005249	C-CER,CHIP	100nF,10%,50V,X7R,1608	1	SNA
C407	2203-005249	C-CER,CHIP	100nF,10%,50V,X7R,1608	1	SNA
C501	2203-005249	C-CER,CHIP	100nF,10%,50V,X7R,1608	1	SNA
C801	2203-005249	C-CER,CHIP	100nF,10%,50V,X7R,1608	1	SNA
C901	2203-005249	C-CER,CHIP	100nF,10%,50V,X7R,1608	1	SNA
XC71	2301-001220	C-FILM,LEAD-PPF	100nF,10%,275V,BK,18x6x12,15	1	SNA
XC72	2301-001220	C-FILM,LEAD-PPF	100nF,10%,275V,BK,18x6x12,15	1	SNA
CR71	2301-001251	C-FILM,LEAD-PPF	1.2uF,10%,450Vac,BK,38x18x30,3	1	SNA
C105	2401-000037	C-AL	470uF,20%,16V,GP,TP,8x11.5,5	1	SNA
C103	2401-000151	C-AL	1000uF,20%,25V,GP,TP,10x20,5	1	SNA
C601	2401-002300	C-AL	47?F,20%,50V,GP,TP,6.3x11,5mm	1	SNA
C111	2401-003518	C-AL	6.8uF,20%,450V,GP,TP,10x16mm,5	1	SNA
C112	2401-003518	C-AL	6.8uF,20%,450V,GP,TP,10x16mm,5	1	SNA
L101	2702-001118	INDUCTOR-RADIAL	5000uH,10%,8.0x11.0mm	1	SNA
XTAL51	2802-001179	RESONATOR-CERAMIC	4MHZ,0.5%,BK,8X3X5.5MM	1	SNA
BZ61	3002-001129	BUZZER-PIEZO	85DB,-,2KHZ,-	1	SNA
RY74	3501-001154	RELAY-MINIATURE	12Vdc,200mW,3000mA,1FormA,10mS,10mS	1	SNA
RY71	3501-001169	RELAY-POWER	12VDC,0.9W,20000MA,SPST,20MS,10MS	1	SNA
SS71	3502-000115	SSR	12Vdc,-,2A,1mS,1mS	1	SNA
F701-1	3601-000263	FUSE-CARTRIDGE	250V,3.15A,TIME-LAG,GLASS,5x20mm	1	SNA
F702	3601-001209	FUSE-RADIAL LEAD	250V,1A,TIME-LAG,-,8.5x8mm	1	SNA
CN72	3711-000262	HEADER-BOARD TO CABLE	1WALL,3P,1R,7.92MM,STRAIGHT,SN,WHT	1	SNA
CN44	3711-000879	HEADER-BOARD TO CABLE	BOX,3P,1R,2.5mm,STRAIGHT,SN,BLU	1	SNA
CN80	3711-000941	HEADER-BOARD TO CABLE	BOX,4P,1R,2.5mm,STRAIGHT,SN	1	SNA
CN71	3711-003404	HEADER-BOARD TO CABLE	1WALL,2P,1R,7.92mm,STRAIGHT,SN,BLU	1	SNA
CN91	3711-004352	HEADER-BOARD TO CABLE	BOX,15P,1R,2mm,STRAIGHT,SN,NTR	1	SNA
CN43	3711-004379	HEADER-BOARD TO CABLE	BOX,4P,1R,2mm,STRAIGHT,SN,NTR	1	SNA
CN61	3711-004484	HEADER-BOARD TO CABLE	BOX,5P,1R,2mm,STRAIGHT,SN,NTR	1	SNA
ST11	DB26-00015A	TRANS SWITCHING	-,JT1916-09,-,310V,FERRITE,-,EI1916,130KHZ,-,1.65MH,-,,-,SHIELD	1	SNA
FT71	DB27-00017A	COIL CHOKE	USAV-07153,UU1116,15.0mH,-25?~+85?,-,1.3ohm,-,15mH,105,20*18mm,13,0.6,BK,-25?	1	SNA
	DB41-00526A	PCB MAIN	VIVACE-PJT 9K/12K,CEM-3,2,1.0,T 1.6mm,160*140mm,-,2,-,-	1	SNA
F701	DB61-00924A	HOLDER-FUSE	-,FH-51B,-,,-,SSEC	1	SNA
IC04	DB91-00376A	ASSY-MICOM	INV-Vivace1,MB90F823, 80P, ROM 128K bytes	1	SNA
	DB93-04814A	ASSY CONNECTOR WIRE	FORTE1-PJT,UL1015 20AWG	1	SNA
CN63	3711-000999	HEADER-BOARD	TO CABLE BOX,5P,2.5mm,STRAIGHT,WHT	1	SNA
CN21	DB93-04256A	ASSY PCB SUB	ASSY PCB COMM AC	1	SA

■ SUB PCB : DB93-04256A

Location No.	Code No.	Description	Specification	Q'TY	SA/SNA	Remark
C301	2203-000440	C-CER,CHIP	1nF,10%,50V,X7R,1608	1	SNA	
C302	2203-000257	C-CER,CHIP	10nF,10%,50V,X7R,1608	1	SNA	
C303	2203-000257	C-CER,CHIP	10nF,10%,50V,X7R,1608	1	SNA	
C701	2401-001428	C-AL	470uF,20%,50V,GP,TP,10x20,5	1	SNA	
C702	2301-000141	C-FILM,LEAD-PEF	10nF,10%,630V,TP,16x11x7.5mm,5	1	SNA	
C703	2301-000256	C-FILM,LEAD-PEF	4.7nF,10%,100V,TP,10x8.5x5.0mm	1	SNA	
C704	2301-000256	C-FILM,LEAD-PEF	4.7nF,10%,100V,TP,10x8.5x5.0mm	1	SNA	
C705	2203-001562	C-CER,CHIP	10nF,+80-20%,50V,Y5V,2012	1	SNA	
C706	2203-000444	C-CER,CHIP	1nF,10%,50V,X7R,2012	1	SNA	
CN11	3711-006040	HEADER-BOARD TO BOARD	NOWALL,10P,2R,2.54mm,ANGLE,AU,BLK	1	SNA	
D701	0402-001213	DIODE-RECTIFIER	MRA4005,600V,1A,SMC,TP	1	SNA	
D702	0402-001213	DIODE-RECTIFIER	MRA4005,600V,1A,SMC,TP	1	SNA	
D703	0402-001213	DIODE-RECTIFIER	MRA4005,600V,1A,SMC,TP	1	SNA	
PC31	0604-001172	PHOTO-COUPLER	TR,100-300,200mW,SOP,TP	1	SNA	
PC32	0604-001172	PHOTO-COUPLER	TR,100-300,200mW,SOP,TP	1	SNA	
Q301	0504-001064	TR-DIGITAL	DTC114EKA,NPN,200mW,10K/10K,SOT-23,TP	1	SNA	
Q302	0504-001064	TR-DIGITAL	DTC114EKA,NPN,200mW,10K/10K,SOT-23,TP	1	SNA	
R301	2007-000078	R-CHIP	1Kohm,5%,1/10W,TP,1608	1	SNA	
R302	2007-000077	R-CHIP	470ohm,5%,1/10W,TP,1608	1	SNA	
R303	2007-000084	R-CHIP	4.7Kohm,5%,1/10W,TP,1608	1	SNA	
R701	2003-000855	R-METAL OXIDE(S)	47Kohm,5%,3W,AA,TP,6x16mm	1	SNA	
R702	2003-000855	R-METAL OXIDE(S)	47Kohm,5%,3W,AA,TP,6x16mm	1	SNA	
R703	2003-002007	R-METAL OXIDE(S)	4.7Kohm,5%,2W,AF,TP,3.9x10mm	1	SNA	
R704	2003-002007	R-METAL OXIDE(S)	4.7Kohm,5%,2W,AF,TP,3.9x10mm	1	SNA	
R706	2007-000282	R-CHIP	100Kohm,5%,1/8W,TP,2012	1	SNA	
R707	2007-000468	R-CHIP	1Kohm,5%,1/8W,TP,2012	1	SNA	
ZD71	0403-000537	DIODE-ZENER	1N4749A,5%,1000mW,DO-41,TP	1	SNA	
-	DB41-00527A	PCB SUB	FORTE,CEM-3,2,1.0,T1.6,50x33mm,-,9,-,COMM AC	1	SNA	
-	DB93-04350B	ASS'Y CONNECTOR WIRE-PCB	AQV12FA,12K_In	1	SNA	

OUTDOOR PCB : DB93-04263C(AQV12VBCX), DB93-04263D(AQV09VBCX)

Location No.	Code No.	Description	Specification	Q'ty	SA/SNA
D102	0402-000351	DIODE-RECTIFIER	1N4937,600V,1A,DO-41,TP	1	SNA
D107	0402-000351	DIODE-RECTIFIER	1N4937,600V,1A,DO-41,TP	1	SNA
D401	0402-000351	DIODE-RECTIFIER	1N4937,600V,1A,DO-41,TP	1	SNA
D402	0402-000351	DIODE-RECTIFIER	1N4937,600V,1A,DO-41,TP	1	SNA
D403	0402-000351	DIODE-RECTIFIER	1N4937,600V,1A,DO-41,TP	1	SNA
D104	0402-001427	DIODE-RECTIFIER	ES1D,200V,1A,DO-214AC,TP	1	SNA
D105	0402-001427	DIODE-RECTIFIER	ES1D,200V,1A,DO-214AC,TP	1	SNA
D106	0402-001427	DIODE-RECTIFIER	ES1D,200V,1A,DO-214AC,TP	1	SNA
D301	0402-001427	DIODE-RECTIFIER	ES1D,200V,1A,DO-214AC,TP	1	SNA
ZD31	0403-000161	DIODE-ZENER	1N4751,28.5-31.5(5%),1000MW,DO-41,TP	1	SNA
ZD23	0403-000258	DIODE-ZENER	BZX84C5V6,5.2-6V,225mW,SOT-23,TP	1	SNA
ZD11	0403-001499	DIODE-ZENER	MMSZ5252,5%,500mW,SOD-123,TP	1	SNA
D201	0407-000123	DIODE-ARRAY	DAN202K,80V,100mA,CA2-3,SOT-23,TP	1	SNA
D451	0407-000123	DIODE-ARRAY	DAN202K,80V,100mA,CA2-3,SOT-23,TP	1	SNA
Q301	0504-000127	TR-DIGITAL	FJV3102RMTF,NPN,200MW,10K/10K,SOT-23,TP	1	SNA
Q302	0504-000127	TR-DIGITAL	FJV3102RMTF,NPN,200MW,10K/10K,SOT-23,TP	1	SNA
Q801	0504-000127	TR-DIGITAL	FJV3102RMTF,NPN,200MW,10K/10K,SOT-23,TP	1	SNA
Q902	0504-000127	TR-DIGITAL	FJV3102RMTF,NPN,200MW,10K/10K,SOT-23,TP	1	SNA
IC55	0506-000175	TR-ARRAY	2003,NPN,7,1W,SOP-16,ST,1000	1	SNA
IC56	0506-000175	TR-ARRAY	2003,NPN,7,1W,SOP-16,ST,1000	1	SNA
Q803	0508-001132	TR-IGBT	-600V,40A,2.6V,1200UJ,160W,TO-3P	1	SNA
IC12	0604-001172	PHOTO-COUPLER	TR,100-300,200mW,SOP,TP	1	SNA
IC31	0604-001172	PHOTO-COUPLER	TR,100-300,200mW,SOP,TP	1	SNA
IC32	0604-001172	PHOTO-COUPLER	TR,100-300,200mW,SOP,TP	1	SNA
IC701	1103-001175	IC-EEPROM	93LC56,128x16,SOP,8P,5x4mm,2.5/6.0V,-40to+85C	1	SNA
IC41	1201-000166	IC-OP AMP	LM358,SOP,ST,8P,150MIL,DUAL,100V/mV,PLASTIC,32V,530mW,0to+70C,70dB,0.6V/uS,5nA	1	SNA
IC21	1202-000104	IC-VOLTAGE COMP.	393,SOP,8P,150MIL,DUAL,36V,CMOS,PLASTIC,18V,780mW,0to+70C,18V,5mV,250nA,50NA,30	1	SNA
IC42	1202-000104	IC-VOLTAGE COMP.	393,SOP,8P,150MIL,DUAL,36V,CMOS,PLASTIC,18V,780mW,0to+70C,18V,5mV,250nA,50NA,30	1	SNA
IC19	1203-000274	IC-POSI.FIXED REG.	7805,TO-220,3P,-,PLASTIC,4.8/5	1	SNA
IC13	1203-002948	IC-POSI.ADJUST REG.	TL431ACD,SOP,8P,4.9X3.9MM,PLASTIC,36V,1.5W,0TO+70C,150MA,2.44/2.55V,TP	1	SNA
IC02	1203-003334	IC-RESET	S-801,SOT-23,5P,2.9x1.6mm,PLASTIC,3.716/4.284V,256mW,-,2.5mA,-,TP	1	SNA
R301	2003-000685	R-METAL OXIDE(S)	4.7Kohm,5%,2W,AA,TP,4x12mm	1	SNA
R307	2003-000685	R-METAL OXIDE(S)	4.7Kohm,5%,2W,AA,TP,4x12mm	1	SNA
R107	2003-000699	R-METAL OXIDE(S)	470ohm,5%,1W,AA,TP,3.3x9mm	1	SNA
R101	2003-000855	R-METAL OXIDE(S)	47Kohm,5%,3W,AA,TP,6x16mm	1	SNA
R418	2006-001013	R-CEMENT	0.02ohm,5%,7W,CA,BK,35x9.5x9.5mm	1	SNA
R308	2007-000070	R-CHIP	0ohm,5%,1/10W,TP,1608	1	SNA
R419	2007-000074	R-CHIP	100ohm,5%,1/10W,TP,1608	1	SNA
R420	2007-000074	R-CHIP	100ohm,5%,1/10W,TP,1608	1	SNA
R421	2007-000074	R-CHIP	100ohm,5%,1/10W,TP,1608	1	SNA
R422	2007-000074	R-CHIP	100ohm,5%,1/10W,TP,1608	1	SNA
R423	2007-000074	R-CHIP	100ohm,5%,1/10W,TP,1608	1	SNA
R424	2007-000074	R-CHIP	100ohm,5%,1/10W,TP,1608	1	SNA
R425	2007-000074	R-CHIP	100ohm,5%,1/10W,TP,1608	1	SNA

OUTDOOR PCB : DB93-04263C(AQV12VBCX), DB93-04263D(AQV09VBCX)(cont.)

Location No.	Code No.	Description	Specification	Q'ty	SA/SNA
R471	2007-000074	R-CHIP	100ohm,5%,1/10W,TP,1608	1	SNA
R472	2007-000074	R-CHIP	100ohm,5%,1/10W,TP,1608	1	SNA
R505	2007-000076	R-CHIP	330ohm,5%,1/10W,TP,1608	1	SNA
R506	2007-000076	R-CHIP	330ohm,5%,1/10W,TP,1608	1	SNA
R507	2007-000076	R-CHIP	330ohm,5%,1/10W,TP,1608	1	SNA
R508	2007-000076	R-CHIP	330ohm,5%,1/10W,TP,1608	1	SNA
R509	2007-000076	R-CHIP	330ohm,5%,1/10W,TP,1608	1	SNA
R510	2007-000076	R-CHIP	330ohm,5%,1/10W,TP,1608	1	SNA
R303	2007-000077	R-CHIP	470ohm,5%,1/10W,TP,1608	1	SNA
R304	2007-000077	R-CHIP	470ohm,5%,1/10W,TP,1608	1	SNA
R554	2007-000077	R-CHIP	470ohm,5%,1/10W,TP,1608	1	SNA
R302	2007-000078	R-CHIP	1Kohm,5%,1/10W,TP,1608	1	SNA
R543	2007-000078	R-CHIP	1Kohm,5%,1/10W,TP,1608	1	SNA
R207	2007-000080	R-CHIP	2Kohm,5%,1/10W,TP,1608	1	SNA
R208	2007-000080	R-CHIP	2Kohm,5%,1/10W,TP,1608	1	SNA
R104	2007-000082	R-CHIP	3.3Kohm,5%,1/10W,TP,1608	1	SNA
R413	2007-000082	R-CHIP	3.3Kohm,5%,1/10W,TP,1608	1	SNA
R305	2007-000084	R-CHIP	4.7Kohm,5%,1/10W,TP,1608	1	SNA
R415	2007-000084	R-CHIP	4.7Kohm,5%,1/10W,TP,1608	1	SNA
R461	2007-000084	R-CHIP	4.7Kohm,5%,1/10W,TP,1608	1	SNA
R105	2007-000087	R-CHIP	6.8Kohm,5%,1/10W,TP,1608	1	SNA
R515	2007-000090	R-CHIP	10Kohm,5%,1/10W,TP,1608	1	SNA
R516	2007-000090	R-CHIP	10Kohm,5%,1/10W,TP,1608	1	SNA
R517	2007-000090	R-CHIP	10Kohm,5%,1/10W,TP,1608	1	SNA
R537	2007-000090	R-CHIP	10Kohm,5%,1/10W,TP,1608	1	SNA
R538	2007-000090	R-CHIP	10Kohm,5%,1/10W,TP,1608	1	SNA
R460	2007-000093	R-CHIP	20Kohm,5%,1/10W,TP,1608	1	SNA
R459	2007-000097	R-CHIP	47Kohm,5%,1/10W,TP,1608	1	SNA
R536	2007-000109	R-CHIP	1Mohm,5%,1/10W,TP,1608	1	SNA
R306	2007-000119	R-CHIP	560ohm,5%,1/10W,TP,1608	1	SNA
R205	2007-000263	R-CHIP	1.82Kohm,1%,1/8W,TP,2012	1	SNA
R206	2007-000263	R-CHIP	1.82Kohm,1%,1/8W,TP,2012	1	SNA
R805	2007-000300	R-CHIP	10Kohm,5%,1/8W,TP,2012	1	SNA
R901	2007-000300	R-CHIP	10Kohm,5%,1/8W,TP,2012	1	SNA
R902	2007-000300	R-CHIP	10Kohm,5%,1/8W,TP,2012	1	SNA
R908	2007-000300	R-CHIP	10Kohm,5%,1/8W,TP,2012	1	SNA
R116	2007-000385	R-CHIP	14.3Kohm,1%,1/4W,TP,3216	1	SNA
R539	2007-000493	R-CHIP	2.2Kohm,5%,1/8W,TP,2012	1	SNA
R540	2007-000493	R-CHIP	2.2Kohm,5%,1/8W,TP,2012	1	SNA
R541	2007-000493	R-CHIP	2.2Kohm,5%,1/8W,TP,2012	1	SNA
R453	2007-000516	R-CHIP	2.7Kohm,1%,1/10W,TP,1608	1	SNA
R807	2007-000553	R-CHIP	20ohm,5%,1/4W,TP,3216	1	SNA
R407	2007-000781	R-CHIP	33ohm,5%,1/8W,TP,2012	1	SNA
R408	2007-000781	R-CHIP	33ohm,5%,1/8W,TP,2012	1	SNA
R409	2007-000781	R-CHIP	33ohm,5%,1/8W,TP,2012	1	SNA

OUTDOOR PCB : DB93-04263C(AQV12VBCX), DB93-04263D(AQV09VBCX)(cont.)

Location No.	Code No.	Description	Specification	Q'ty	SA/SNA
R113	2007-000924	R-CHIP	470Kohm,1%,1/4W,TP,3216	1	SNA
R114	2007-000924	R-CHIP	470Kohm,1%,1/4W,TP,3216	1	SNA
R115	2007-000924	R-CHIP	470Kohm,1%,1/4W,TP,3216	1	SNA
R808	2007-000931	R-CHIP	470ohm,5%,1/8W,TP,2012	1	SNA
R806	2007-000950	R-CHIP	47ohm,5%,1/4W,TP,3216	1	SNA
R501	2007-000962	R-CHIP	5.1Kohm,1%,1/10W,TP,1608	1	SNA
R504	2007-000962	R-CHIP	5.1Kohm,1%,1/10W,TP,1608	1	SNA
R542	2007-000964	R-CHIP	5.1Kohm,5%,1/8W,TP,2012	1	SNA
R462	2007-000986	R-CHIP	5.6ohm,5%,1/8W,TP,2012	1	SNA
R463	2007-000986	R-CHIP	5.6ohm,5%,1/8W,TP,2012	1	SNA
R464	2007-000986	R-CHIP	5.6ohm,5%,1/8W,TP,2012	1	SNA
R906	2007-001071	R-CHIP	6.8Kohm,5%,1/8W,TP,2012	1	SNA
R101	2007-001118	R-CHIP	680ohm,5%,1/8W,TP,2012	1	SNA
R429	2007-001652	R-CHIP	1.6Kohm,1%,1/8W,TP,2012	1	SNA
R201	2007-002667	R-CHIP	90.9Kohm,1%,1/4W,TP,3216	1	SNA
R202	2007-002667	R-CHIP	90.9Kohm,1%,1/4W,TP,3216	1	SNA
R203	2007-002667	R-CHIP	90.9Kohm,1%,1/4W,TP,3216	1	SNA
R204	2007-002667	R-CHIP	90.9Kohm,1%,1/4W,TP,3216	1	SNA
R430	2007-007154	R-CHIP	51ohm,1%,1/8W,TP,2012	1	SNA
R502	2007-007237	R-CHIP	24.3Kohm,1%,1/10W,TP,1608	1	SNA
R503	2007-007237	R-CHIP	24.3Kohm,1%,1/10W,TP,1608	1	SNA
R110	2007-008023	R-CHIP	100KOHM,5%,1W,TP,6432	1	SNA
R111	2007-008023	R-CHIP	100KOHM,5%,1W,TP,6432	1	SNA
R112	2007-008023	R-CHIP	100KOHM,5%,1W,TP,6432	1	SNA
R426	2007-008261	R-CHIP	150KOHM,1%,1/2W,TP,5025	1	SNA
R427	2007-008261	R-CHIP	150KOHM,1%,1/2W,TP,5025	1	SNA
R428	2007-008261	R-CHIP	150KOHM,1%,1/2W,TP,5025	1	SNA
R431	2007-008261	R-CHIP	150KOHM,1%,1/2W,TP,5025	1	SNA
R432	2007-008261	R-CHIP	150KOHM,1%,1/2W,TP,5025	1	SNA
R433	2007-008261	R-CHIP	150KOHM,1%,1/2W,TP,5025	1	SNA
R451	2007-009114	R-CHIP	110Kohm,1%,1/2W,TP,5025	1	SNA
R452	2007-009114	R-CHIP	110Kohm,1%,1/2W,TP,5025	1	SNA
R454	2007-009114	R-CHIP	110Kohm,1%,1/2W,TP,5025	1	SNA
C106	2201-000322	C-CERAMIC,DISC	2.2NF,10%,2KV,Y5P,TP,13X5MM,10	1	SNA
C107	2201-000322	C-CERAMIC,DISC	2.2NF,10%,2KV,Y5P,TP,13X5MM,10	1	SNA
C304	2201-000322	C-CERAMIC,DISC	2.2NF,10%,2KV,Y5P,TP,13X5MM,10	1	SNA
C901	2201-000322	C-CERAMIC,DISC	2.2NF,10%,2KV,Y5P,TP,13X5MM,10	1	SNA
C108	2203-000189	C-CER,CHIP	100nF,+80-20%,25V,Y5V,1608	1	SNA
C112	2203-000189	C-CER,CHIP	100nF,+80-20%,25V,Y5V,1608	1	SNA
C116	2203-000189	C-CER,CHIP	100nF,+80-20%,25V,Y5V,1608	1	SNA
C121	2203-000189	C-CER,CHIP	100nF,+80-20%,25V,Y5V,1608	1	SNA
C202	2203-000189	C-CER,CHIP	100nF,+80-20%,25V,Y5V,1608	1	SNA
C408	2203-000189	C-CER,CHIP	100nF,+80-20%,25V,Y5V,1608	1	SNA
C412	2203-000189	C-CER,CHIP	100nF,+80-20%,25V,Y5V,1608	1	SNA
C413	2203-000189	C-CER,CHIP	100nF,+80-20%,25V,Y5V,1608	1	SNA

OUTDOOR PCB : DB93-04263C(AQV12VBCX), DB93-04263D(AQV09VBCX)(cont.)

Location No.	Code No.	Description	Specification	Q'ty	SA/SNA
C414	2203-000189	C-CER,CHIP	100nF,+80-20%,25V,Y5V,1608	1	SNA
C415	2203-000189	C-CER,CHIP	100nF,+80-20%,25V,Y5V,1608	1	SNA
C455	2203-000189	C-CER,CHIP	100nF,+80-20%,25V,Y5V,1608	1	SNA
C471	2203-000189	C-CER,CHIP	100nF,+80-20%,25V,Y5V,1608	1	SNA
C503	2203-000189	C-CER,CHIP	100nF,+80-20%,25V,Y5V,1608	1	SNA
C506	2203-000189	C-CER,CHIP	100nF,+80-20%,25V,Y5V,1608	1	SNA
C507	2203-000189	C-CER,CHIP	100nF,+80-20%,25V,Y5V,1608	1	SNA
C509	2203-000189	C-CER,CHIP	100nF,+80-20%,25V,Y5V,1608	1	SNA
C513	2203-000189	C-CER,CHIP	100nF,+80-20%,25V,Y5V,1608	1	SNA
C514	2203-000189	C-CER,CHIP	100nF,+80-20%,25V,Y5V,1608	1	SNA
C515	2203-000189	C-CER,CHIP	100nF,+80-20%,25V,Y5V,1608	1	SNA
C516	2203-000189	C-CER,CHIP	100nF,+80-20%,25V,Y5V,1608	1	SNA
C517	2203-000189	C-CER,CHIP	100nF,+80-20%,25V,Y5V,1608	1	SNA
C518	2203-000189	C-CER,CHIP	100nF,+80-20%,25V,Y5V,1608	1	SNA
C520	2203-000189	C-CER,CHIP	100nF,+80-20%,25V,Y5V,1608	1	SNA
C522	2203-000189	C-CER,CHIP	100nF,+80-20%,25V,Y5V,1608	1	SNA
C523	2203-000189	C-CER,CHIP	100nF,+80-20%,25V,Y5V,1608	1	SNA
C524	2203-000189	C-CER,CHIP	100nF,+80-20%,25V,Y5V,1608	1	SNA
C525	2203-000189	C-CER,CHIP	100nF,+80-20%,25V,Y5V,1608	1	SNA
C526	2203-000189	C-CER,CHIP	100nF,+80-20%,25V,Y5V,1608	1	SNA
C417	2203-000192	C-CER,CHIP	100nF,+80-20%,50V,Y5V,2012	1	SNA
C419	2203-000192	C-CER,CHIP	100nF,+80-20%,50V,Y5V,2012	1	SNA
C519	2203-000192	C-CER,CHIP	100nF,+80-20%,50V,Y5V,2012	1	SNA
C803	2203-000192	C-CER,CHIP	100nF,+80-20%,50V,Y5V,2012	1	SNA
C201	2203-000257	C-CER,CHIP	10nF,10%,50V,X7R,1608	1	SNA
C203	2203-000257	C-CER,CHIP	10nF,10%,50V,X7R,1608	1	SNA
C302	2203-000257	C-CER,CHIP	10nF,10%,50V,X7R,1608	1	SNA
C305	2203-000257	C-CER,CHIP	10nF,10%,50V,X7R,1608	1	SNA
C306	2203-000257	C-CER,CHIP	10nF,10%,50V,X7R,1608	1	SNA
C307	2203-000257	C-CER,CHIP	10nF,10%,50V,X7R,1608	1	SNA
C521	2203-000257	C-CER,CHIP	10nF,10%,50V,X7R,1608	1	SNA
C303	2203-000440	C-CER,CHIP	1nF,10%,50V,X7R,1608	1	SNA
C421	2203-000440	C-CER,CHIP	1nF,10%,50V,X7R,1608	1	SNA
C105	2203-000609	C-CER,CHIP	22nF,10%,50V,X7R,TP,2012	1	SNA
C802	2203-000609	C-CER,CHIP	22nF,10%,50V,X7R,TP,2012	1	SNA
C452	2203-000888	C-CER,CHIP	4.7nF,10%,50V,X7R,1608	1	SNA
C906	2203-001562	C-CER,CHIP	10nF,+80-20%,50V,Y5V,2012	1	SNA
C907	2203-001562	C-CER,CHIP	10nF,+80-20%,50V,Y5V,2012	1	SNA
C451	2203-002002	C-CER,CHIP	33pF,5%,50V,NPO,BK,1608,-	1	SNA
C402	2203-002041	C-CER,CHIP	0.47nF,10%,50V,X7R,1608	1	SNA
C404	2203-002041	C-CER,CHIP	0.47nF,10%,50V,X7R,1608	1	SNA
C406	2203-002041	C-CER,CHIP	0.47nF,10%,50V,X7R,1608	1	SNA
C407	2203-002041	C-CER,CHIP	0.47nF,10%,50V,X7R,1608	1	SNA
C113	2203-005819	C-CER,CHIP	1000nF,+80-20%,16V,Y5V,-,1608	1	SNA
C900	2203-006104	C-CER,CHIP	1000nF,10%,50V,X7R,3225	1	SNA

■ OUTDOOR PCB : DB93-04263C(AQV12VBCX), DB93-04263D(AQV09VBCX)(cont.)

Location No.	Code No.	Description	Specification	Q'ty	SA/SNA
C401	2203-006325	C-CER,CHIP	1.2nF,5%,25V,SL,TP,1608	1	SNA
C403	2203-006325	C-CER,CHIP	1.2nF,5%,25V,SL,TP,1608	1	SNA
C405	2203-006325	C-CER,CHIP	1.2nF,5%,25V,SL,TP,1608	1	SNA
C453	2203-006325	C-CER,CHIP	1.2nF,5%,25V,SL,TP,1608	1	SNA
C454	2203-006496	C-CER,CHIP	2.2nF,10%,50V,X7R,1608	1	SNA
C462	2203-006496	C-CER,CHIP	2.2nF,10%,50V,X7R,1608	1	SNA
C001	2301-000141	C-FILM,LEAD-PEF	10nF,10%,630V,TP,16x11x7.5mm,5	1	SNA
C301	2301-001331	C-FILM,LEAD-PEF	10nF,5%,100V,TP,7.5x4x7mm,5	1	SNA
C418	2306-000123	C-FILM,LEAD-PPF	100nF,5%,630V,BK,26x16.5x8.5,2	1	SNA
C902	2401-000480	C-AL	10uF,20%,50V,GP,TP,5x11,5	1	SNA
C110	2401-000832	C-AL	220uF,20%,25V,GP,TP,8x11.5,5	1	SNA
C114	2401-000832	C-AL	220uF,20%,25V,GP,TP,8x11.5,5	1	SNA
C119	2401-000832	C-AL	220uF,20%,25V,GP,TP,8x11.5,5	1	SNA
C123	2401-000832	C-AL	220uF,20%,25V,GP,TP,8x11.5,5	1	SNA
C437	2401-001552	C-AL	47uF,20%,35V,GP,TP,6.3x11,2.5	1	SNA
C508	2401-001552	C-AL	47uF,20%,35V,GP,TP,6.3x11,2.5	1	SNA
C409	2401-002300	C-AL	47?F,20%,50V,GP,TP,6.3x11,5mm	1	SNA
C410	2401-002300	C-AL	47?F,20%,50V,GP,TP,6.3x11,5mm	1	SNA
C411	2401-002300	C-AL	47?F,20%,50V,GP,TP,6.3x11,5mm	1	SNA
C416	2401-002598	C-AL	220uF,20%,50V,GP,TP,10x16,5	1	SNA
C902	2401-002598	C-AL	220uF,20%,50V,GP,TP,10x16,5	1	SNA
C702	2401-003036	C-AL	100uF,20%,16V,GP,TP,5X11mm,5mm	1	SNA
C122	2401-003541	C-AL	10uF,20%,450V,WT,TP,12.5x20mm,5	1	SNA
C104	2401-003736	C-AL	22UF,20%,50V,WT,TP,5X11MM,2	1	SNA
XTAL01	2802-001179	RESONATOR-CERAMIC	4MHZ,0.5%,BK,8X3X5.5MM	1	SNA
RY501	3501-001154	RELAY-MINIATURE	12Vdc,200mW,3000mA,1FormA,10mS,10mS	1	SNA
CN52	3711-000015	HEADER-BOARD TO CABLE	BOX,2P,1R,2.5MM,STRAIGHT,SN,WHT	1	SNA
CN51	3711-000939	HEADER-BOARD TO CABLE	BOX,4P,1R,2.5mm,STRAIGHT,SN	1	SNA
CN53	3711-001038	HEADER-BOARD TO CABLE	BOX,6P,1R,2.5mm,STRAIGHT,SN,WHT	1	SNA
CN01	3711-005654	HEADER-BOARD TO CABLE	1WALL,7P,1R,3.96mm,ANGLE,SN,WHT	1	SNA
AC_L	3712-001139	CONNECTOR-TERMINAL	TAB,MALE,-,6.35X0.8MM	1	SNA
AC_N	3712-001139	CONNECTOR-TERMINAL	TAB,MALE,-,6.35X0.8MM	1	SNA
Q901	DB13-00003A	IC DRIVER GATE	-,SOT-23,-,1P,1P,0.2mm,2.93x1.3mm	1	SNA
	DB39-00514F	CBF LEAD WIRE-EARTH	-,KFR-35(25)GW/GPI,-,200,-,-,-,GRN/YEL,-,-,-	1	SNA
	DB41-00529A	PCB MAIN	FORTE,CEM-3,2,1.0,1.6t,160*140,-,1,-,-	1	SNA
IC01	DB91-00381A	ASSY-MICOM	2007 INV Comp Driver,MB90F823, 80P, ROM 128K bytes	1	SNA
	DB93-04336A	ASSY CONNECTOR WIRE	AQV12JAKCV,12K	1	SNA
	DB93-04348B	ASSY CONNECTOR WIRE-REACTOR	AQV12JAKCV,Out_12k	1	SNA
	DB93-04348C	ASSY CONNECTOR WIRE-COMM AC	AQV12FA,Out_12k	1	SNA
	DB93-04349A	ASSY CONNECTOR WIRE-4WAY	AQV12JAKCV,12K_Out	1	SNA
IPM	DB95-00599A	ASSY-IPM	KFR-35GW/GPI,INVERTER	1	SNA

■ **OUTDOOR PCB : DB93-04263C(AQV12VBCX), DB93-04263D(AQV09VBCX)(cont.)**

Location No.	Code No.	Description	Specification	Q'ty	SA/SNA
BD01	DB98-16586A	ASSY-DIODE	-----	1	SNA
D101	DB98-16591A	ASSY-DIODE RECTIFIER	-----	1	SNA
LED2	DB98-16600A	ASSY-LED GREEN	-----	1	SNA
LED1	DB98-16601A	ASSY-LED RED	-----	1	SNA
LED3	DB98-16602A	ASSY-LED YEL	-----	1	SNA
PT02	DB98-20602A	ASSY-PULSE TRANS	KFR-35GW/GPI,INVERTER	1	SNA
R106	DB98-20665A	ASSY-RESISTOR	KFR-35(25)GW/GPI,1.8k F 1608	1	SNA
IC81	DB98-20678A	ASSY-PHOTOCOUPLER	KFR-35(25)GW/GPI,TLP351	1	SNA
IC11	DB98-20679A	ASSY-FPS	KFR-35(25)GW/GPI,FSDH321	1	SNA
C101	DB98-21655A	ASSY-CAP	KFR-35(25)GW,KMH400VS470	1	SNA
C102	DB98-21655A	ASSY-CAP	KFR-35(25)GW,KMH400VS470	1	SNA
C103	DB98-21655A	ASSY-CAP	KFR-35(25)GW,KMH400VS470	1	SNA



EMI PCB : DB93-04264A

Location No.	Code No.	Description	Specification	Q'TY	SA/SNA	Remark
C001	2201-000540	C-CERAMIC,DISC	4.7nF,20%,2kV,Y5U,BK,12x5mm,10	1	SNA	
C002	2201-000540	C-CERAMIC,DISC	4.7nF,20%,2kV,Y5U,BK,12x5mm,10	1	SNA	
C003	2301-001285	C-FILM,LEAD-PPF	680nF,10%,275V,BK,31x11x21mm,27.5	1	SNA	
C004	2301-001325	C-FILM,LEAD-PPF	330nF,10%,275V,TP,26x8.5x18mm,22.5	1	SNA	
C010	2201-000540	C-CERAMIC,DISC	4.7nF,20%,2kV,Y5U,BK,12x5mm,10	1	SNA	
C011	2201-000540	C-CERAMIC,DISC	4.7nF,20%,2kV,Y5U,BK,12x5mm,10	1	SNA	
DSA	4715-001093	SURGE ABSORBER	3600V,20%,2000A,-,AXIAL	1	SNA	
FT00	DB98-17990A	ASSY-EMI FILTER	SH12BWH,LS615044	1	SNA	
FT01	DB98-17990A	ASSY-EMI FILTER	SH12BWH,LS615044	1	SNA	
FUSE	3601-001159	FUSE-CARTRIDGE	250V,20A,SLOW-BLOW,CERAMIC,31.8x6.35mm	1	SNA	
FUSECLIP	3602-001038	FUSE-CLIP	250V,30A,10mohm	1	SNA	
VA04	1405-000154	VARISTOR	460Vdc,2500A,17.5x7.5mm,TP	1	SNA	
VA07	1405-000154	VARISTOR	460Vdc,2500A,17.5x7.5mm,TP	1	SNA	
VA08	1405-000154	VARISTOR	460Vdc,2500A,17.5x7.5mm,TP	1	SNA	
VA09	1405-000154	VARISTOR	460Vdc,2500A,17.5x7.5mm,TP	1	SNA	
-	6042-001009	EYELET	ID1.8,OD2.2,L3,-,BRASS	8	SNA	
-	DB39-00514F	CBF LEAD WIRE-EARTH	-,KFR-35(25)GW/GPI,-,200,-,-,GRN/YEL,-,-,-	1	SNA	
-	DB39-00961T	CBF LEAD WIRE	-,SH12BWH,-,120,10A,230V/50Hz,-,BRW,-,-,INVERTER	1	SNA	
-	DB39-00961U	CBF LEAD WIRE	-,SH12BWH,-,120,10A,230V/50Hz,-,BLU,-,-,INVERTER	1	SNA	
-	DB39-00998C	CBF LEAD WIRE-POWER	-,KFR-35(25)GW,2P,140,-,220V,-,BRN/SKYBLU,-,-,AC POWER WIRE	1	SNA	
-	DB41-00532A	PCB SUB	FORTE,FR-1,1,1,0,1.6T,160x140mm,-,3,-,-	1	SNA	

7. Wiring Diagram

7-1 Indoor Unit

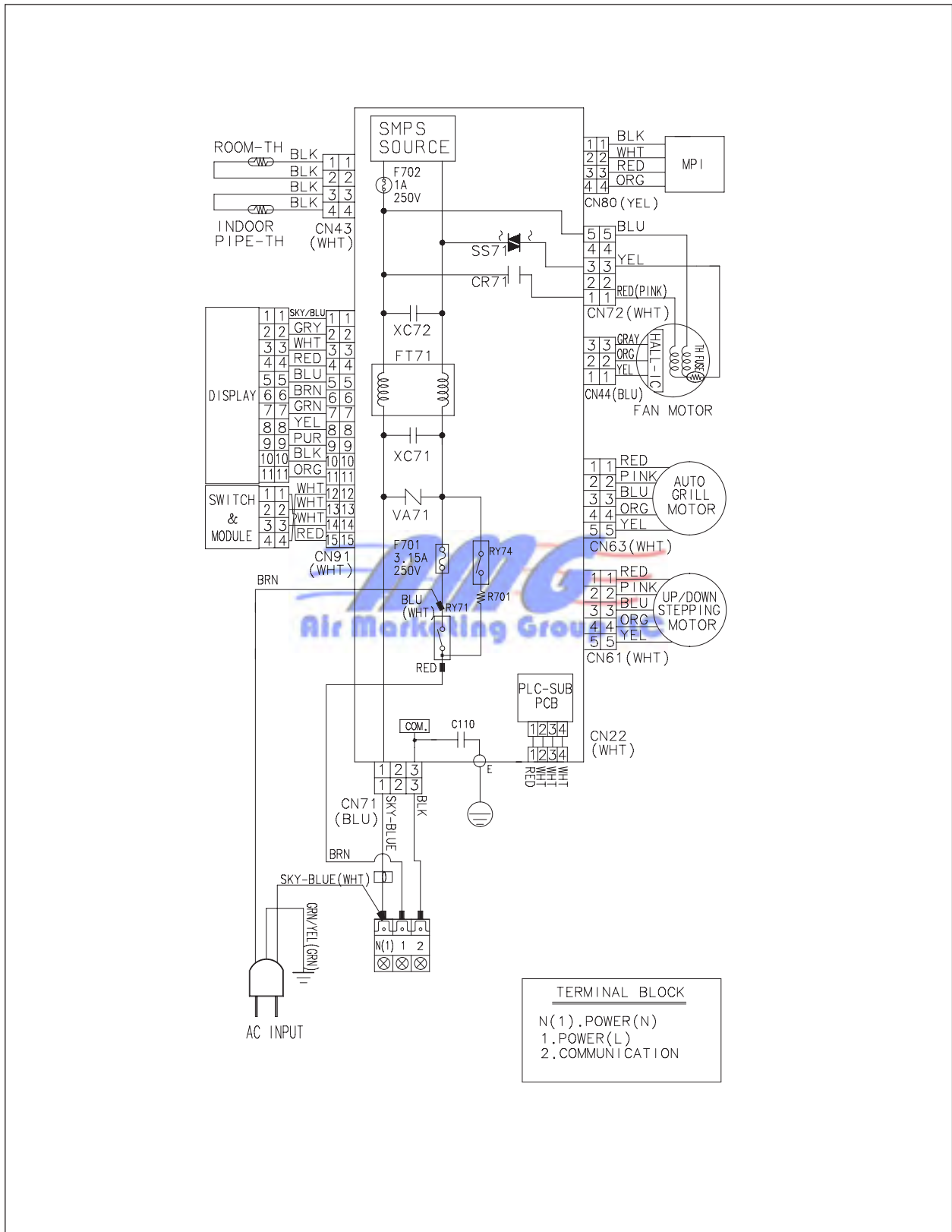

This Document can not be used without Samsung's authorization.

7-2 Outdoor Unit

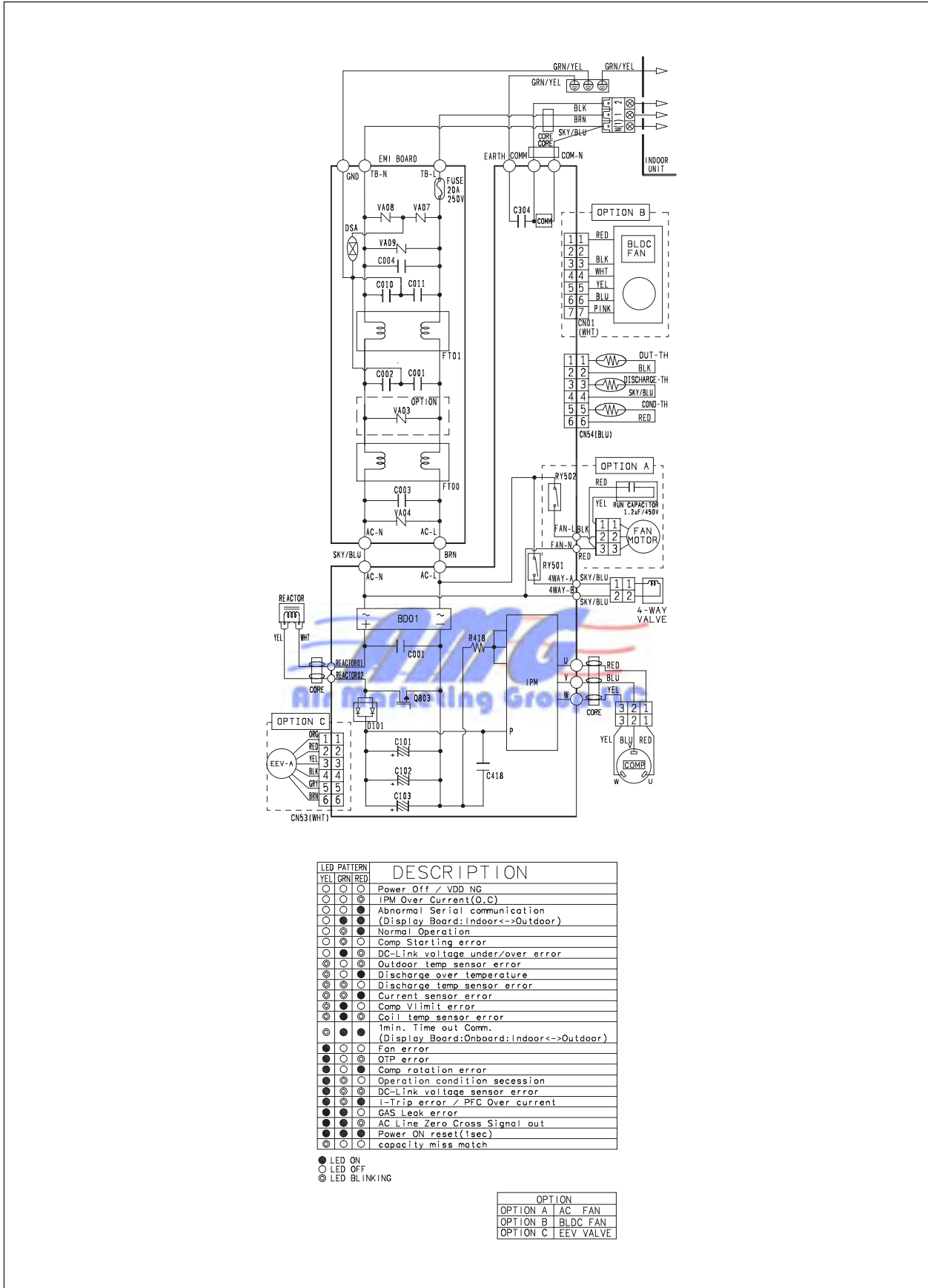

This Document can not be used without Samsung's authorization.

MEMO



8. Schematic Diagram

8-1 Indoor Unit

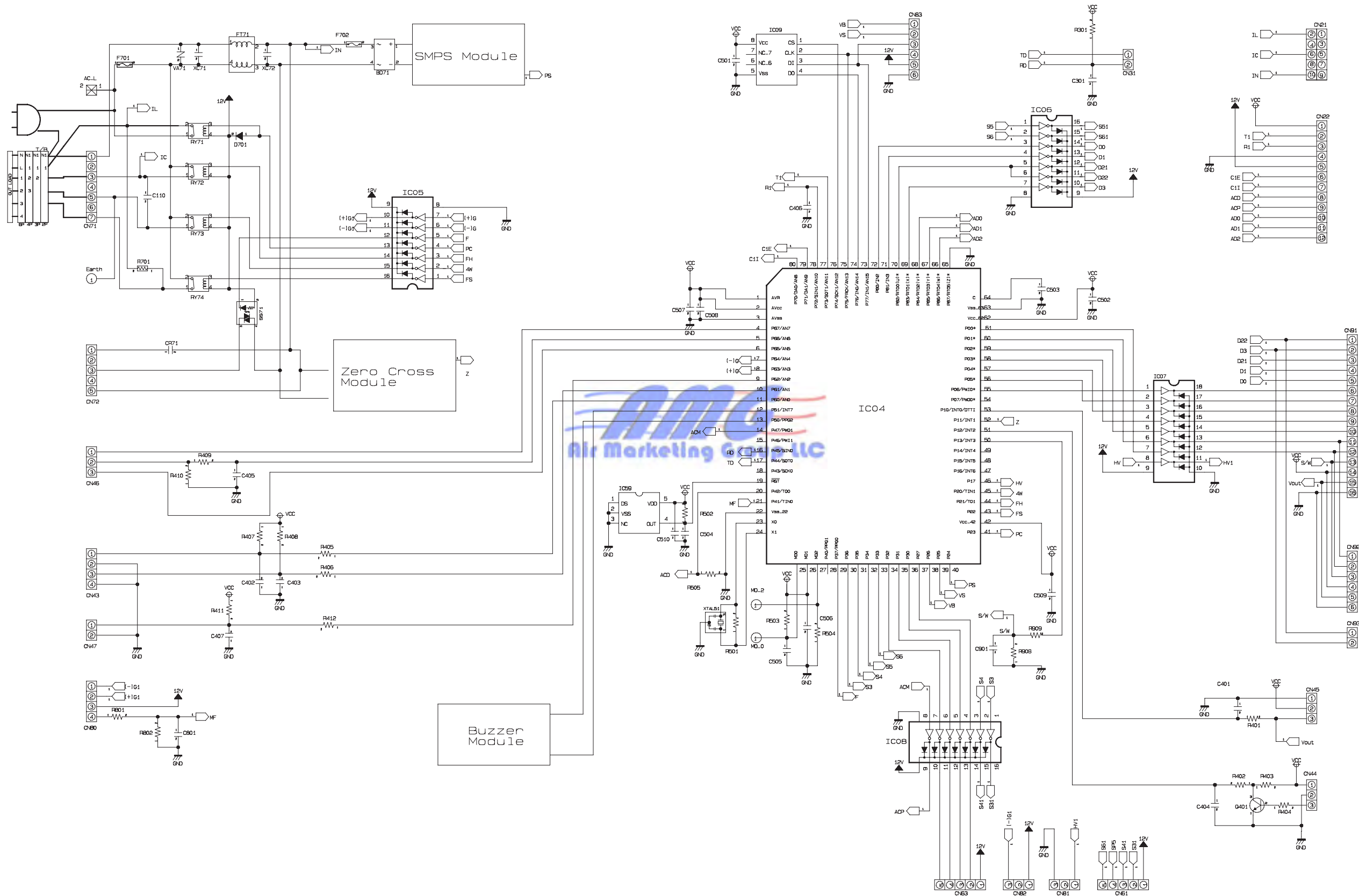

This Document can not be used without Samsung's authorization.

8-2 Outdoor Unit

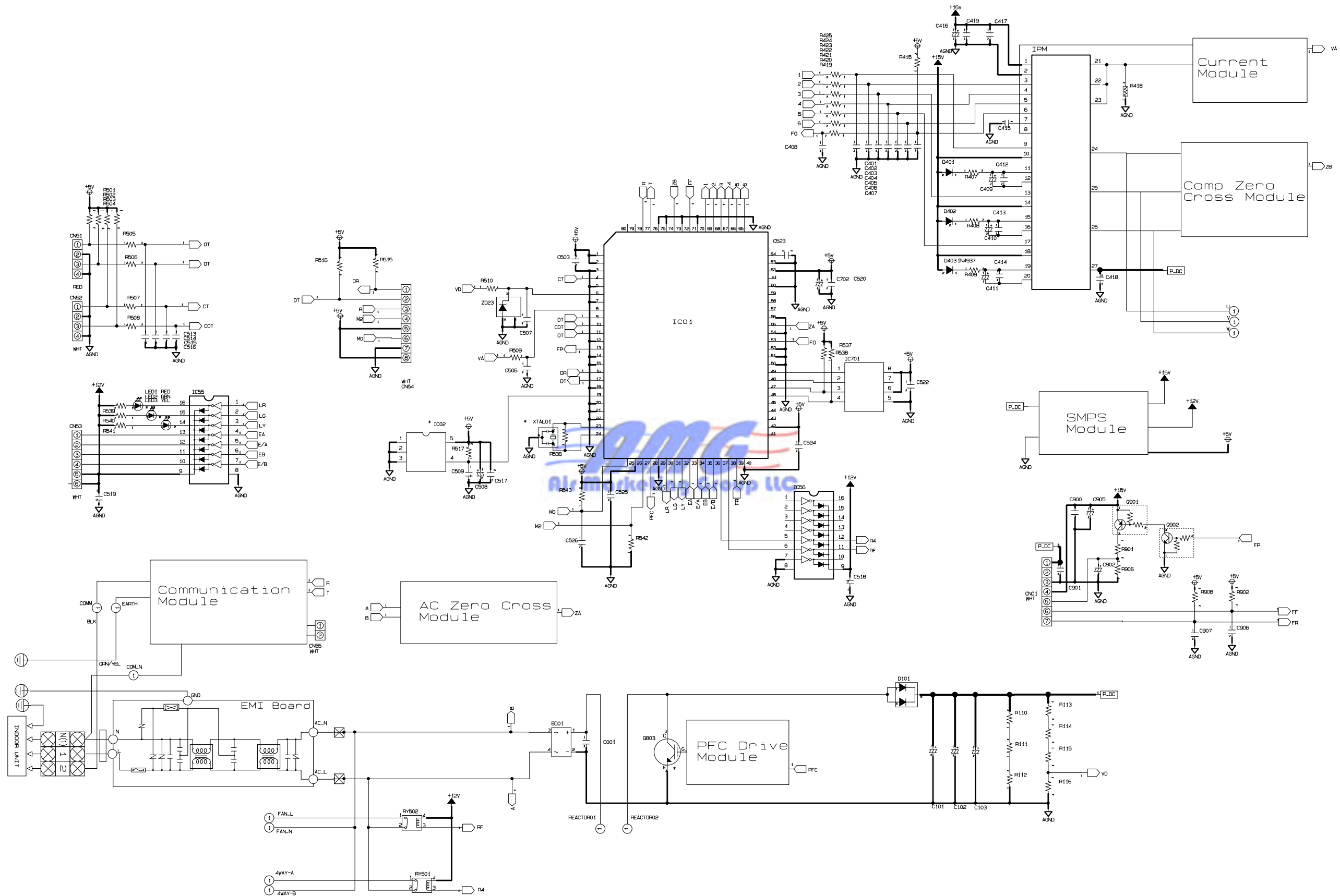

This Document can not be used without Samsung's authorization.

9. Circuit Descriptions

9-1 PCB Circuit Descriptions

9-1-1 Indoor Unit

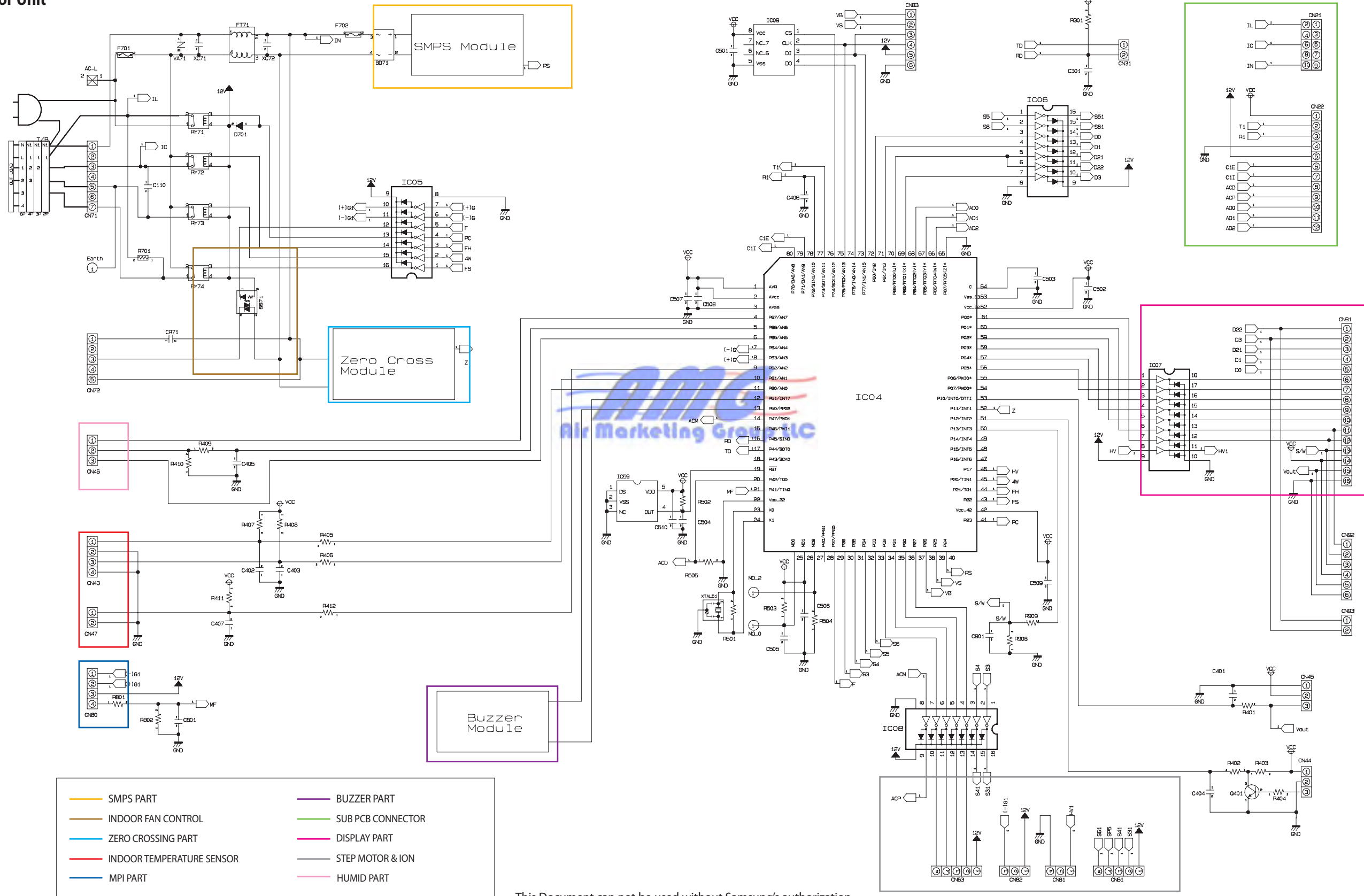

This Document can not be used without Samsung's authorization.

9-1-2 Outdoor Unit

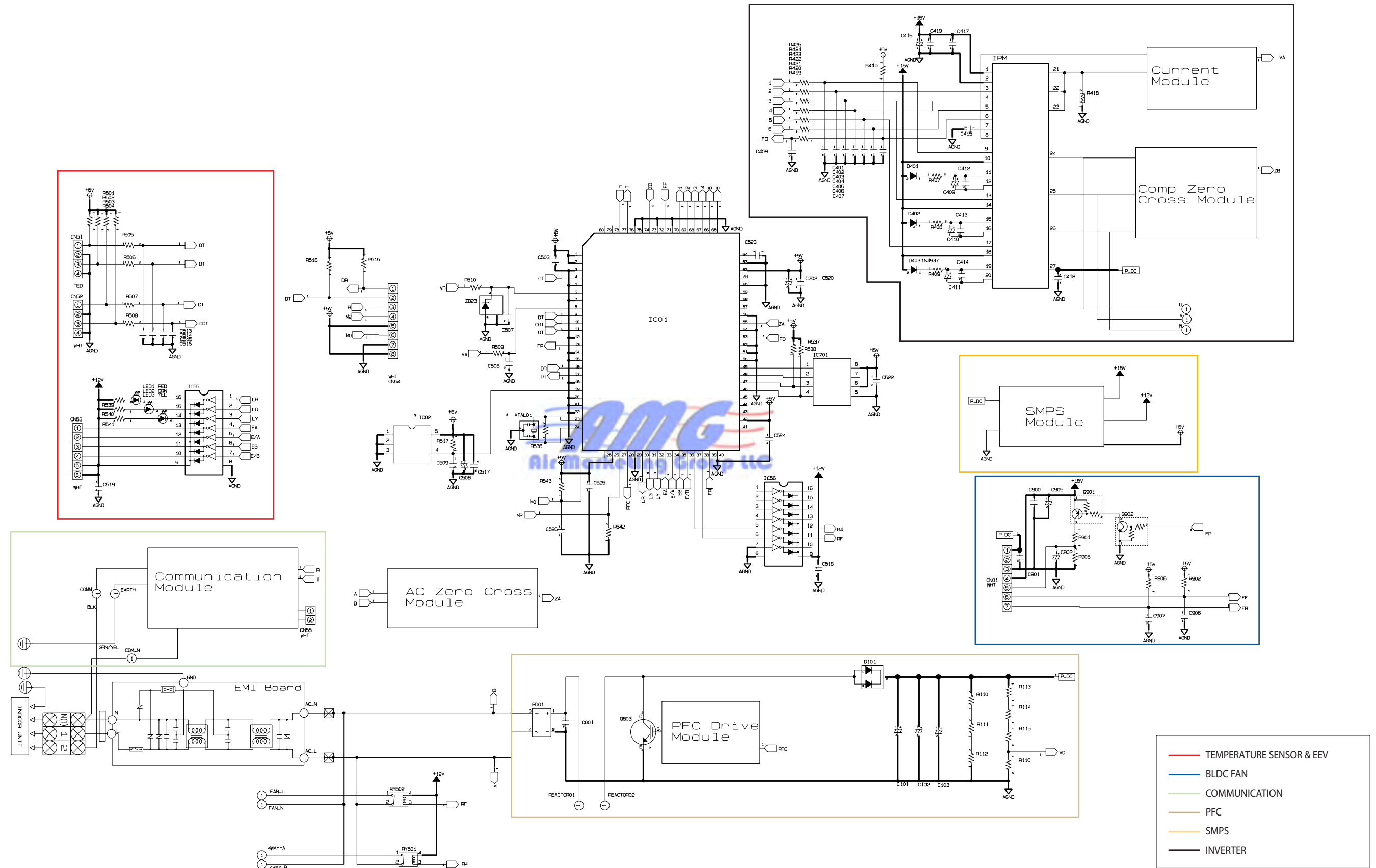

This Document can not be used without Samsung's authorization.

9-2 Refrigerating Cycle Diagram

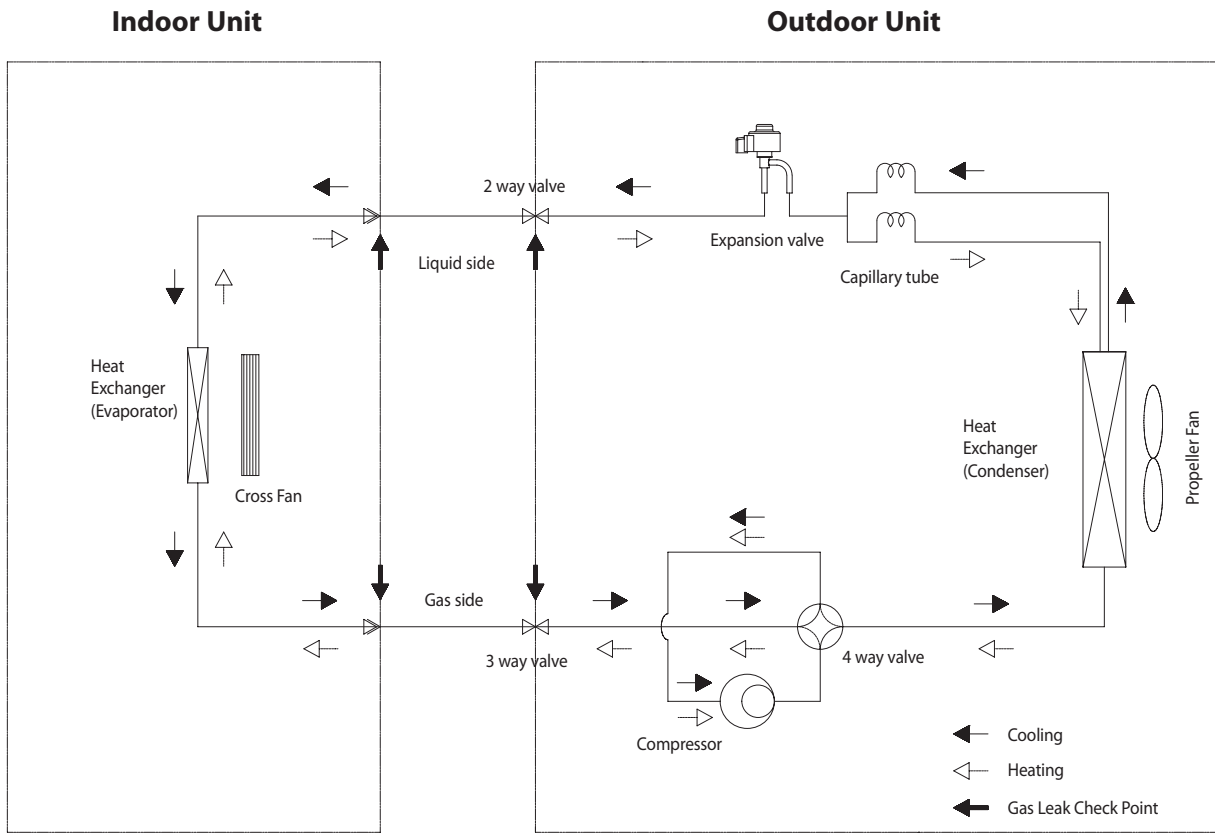

Air Marketing Group LLC

10. PCB Diagram

10-1 Indoor PCB

⚠ The red number connector is not used.

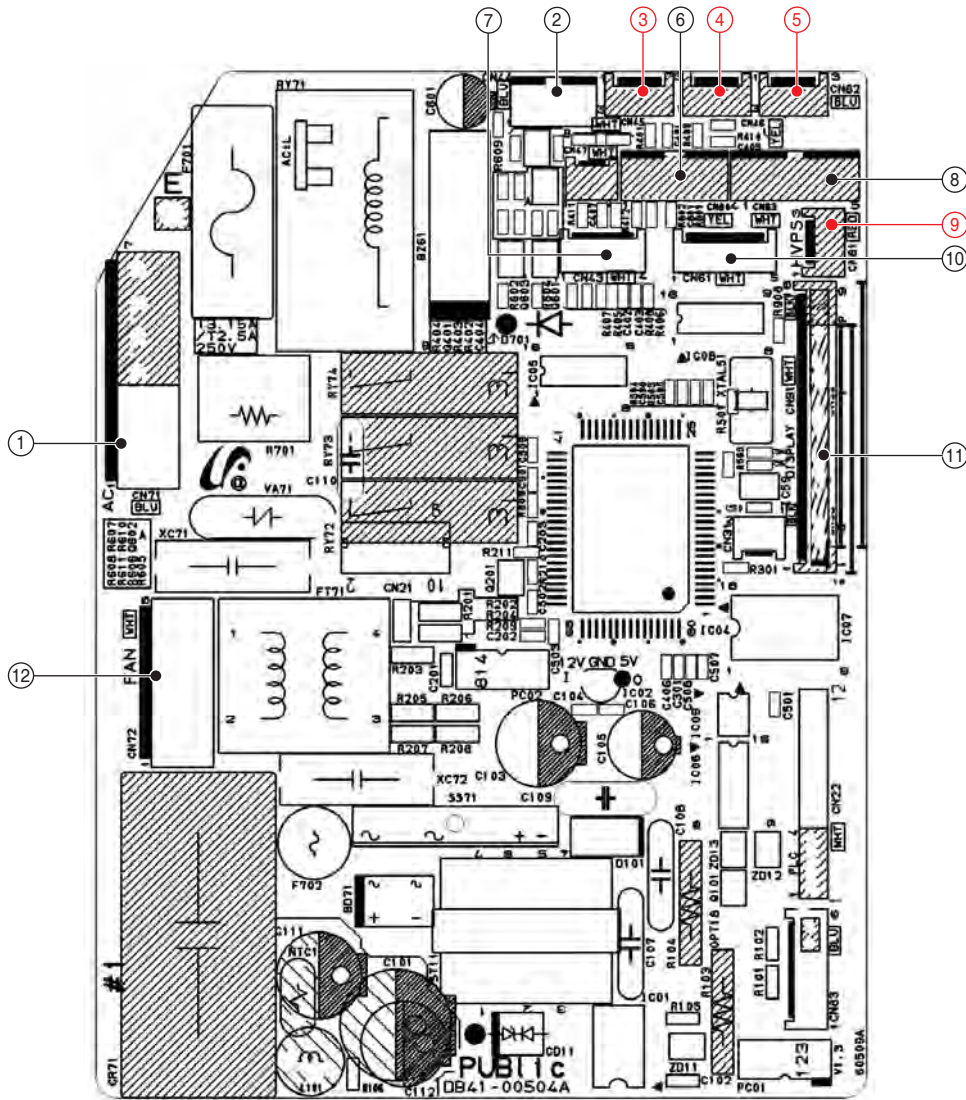

①	Power	⑦	Temperature Sensor
②	Motor RPM Feedback	⑧	Auto Grill
③	Remocon Module	⑨	HVPS(High voltage Generator)
④	Humidity Sensor	⑩	BLADE-H Step Motor
⑤	Anions	⑪	Display
⑥	MPI	⑫	Indoor Fan Motor

10-2 Outdoor PCB

⚠ The red number connector is not used.

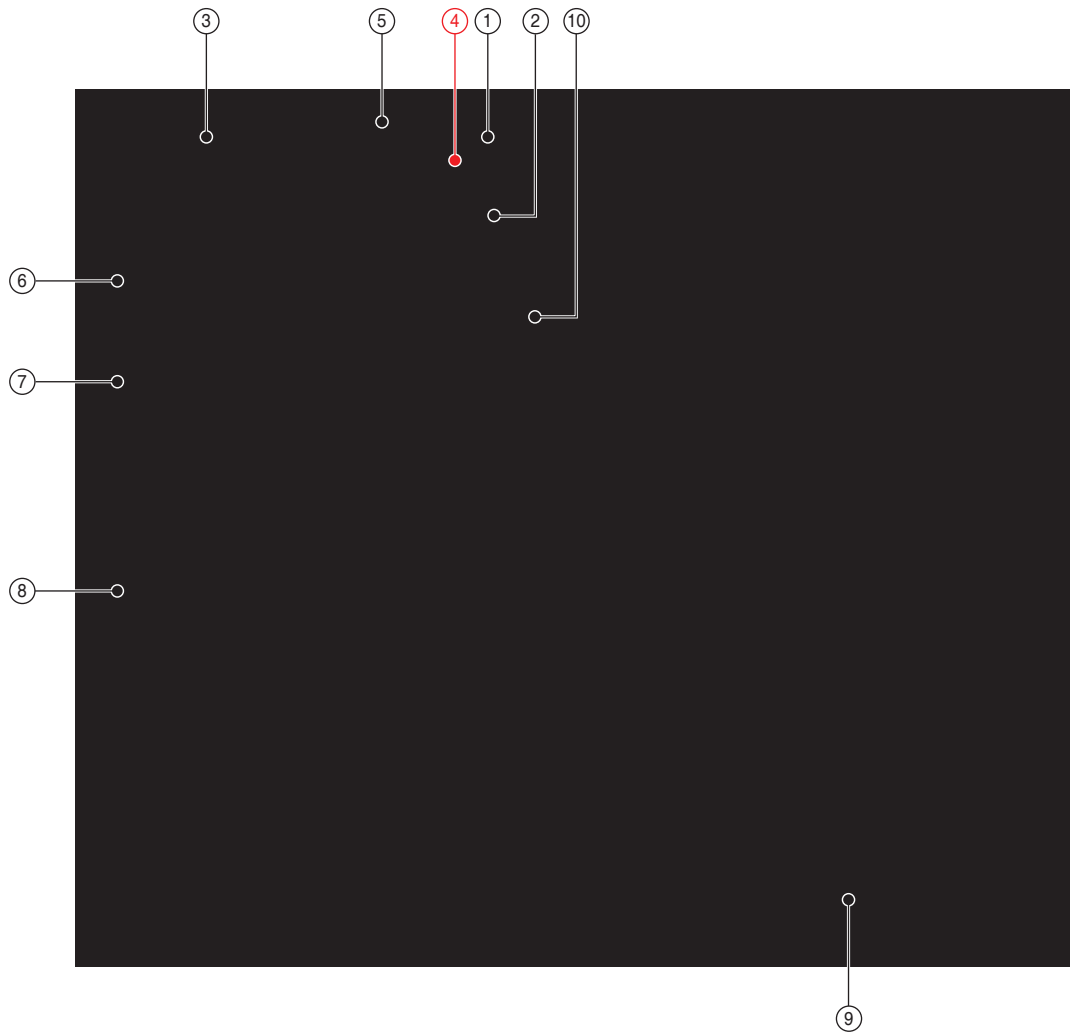

①	Power N	⑥	COND/OLP Temperature Sensor
②	Power L	⑦	DIS/OUT Temperature Sensor
③	BLDC FAN	⑧	EEV Connector
④	AC FAN	⑨	Comp. Connector Wire
⑤	Communication AC	⑩	Reactor Connector Wire

11. Operating Instructions

11-1 Name of Each Part

11-1-1 Indoor Unit

The design and shape are subject to change according to the model.

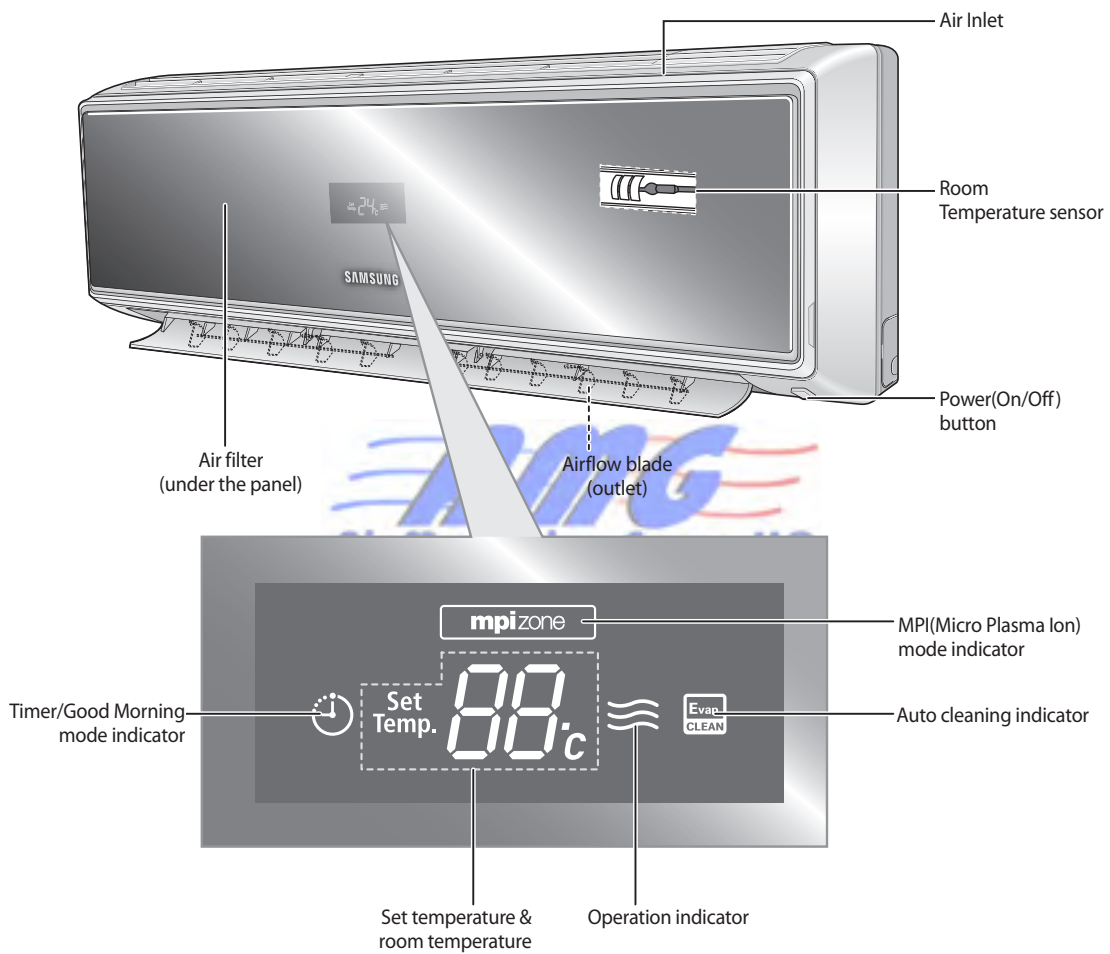

11-1-2 Outdoor Unit

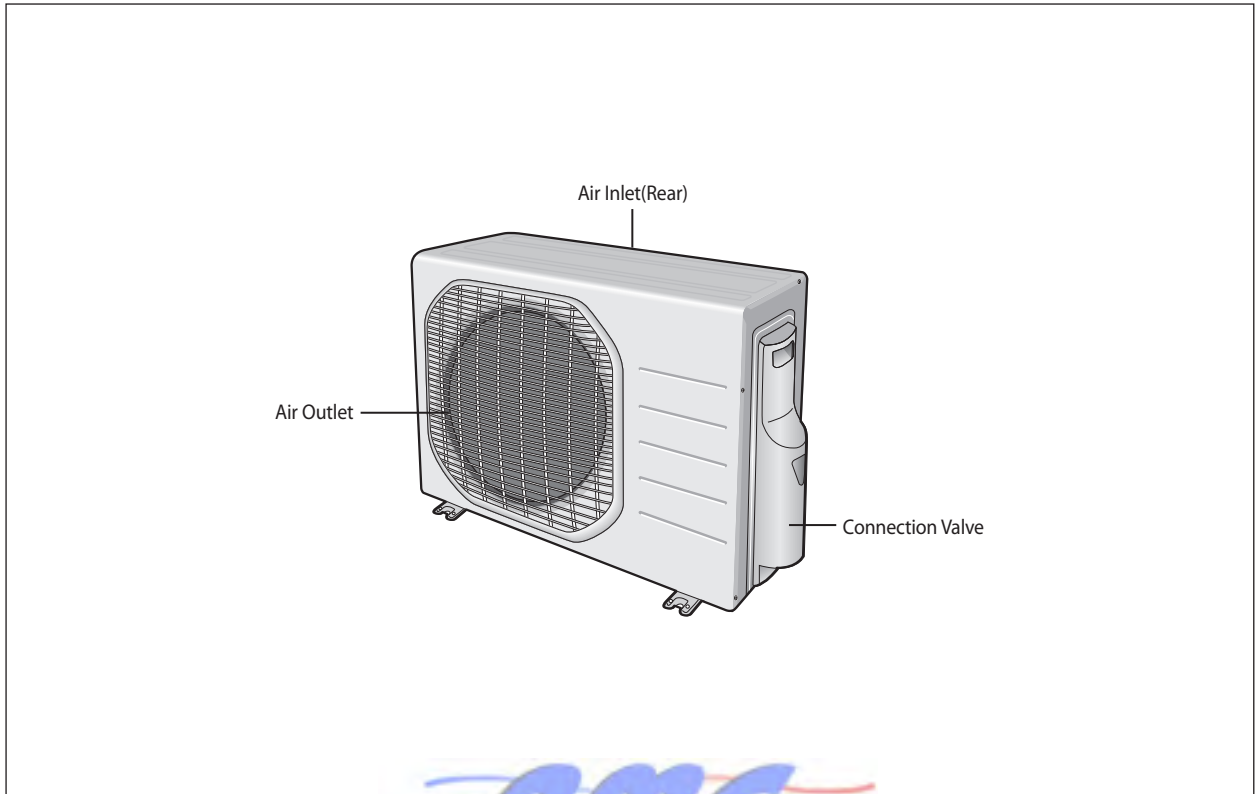



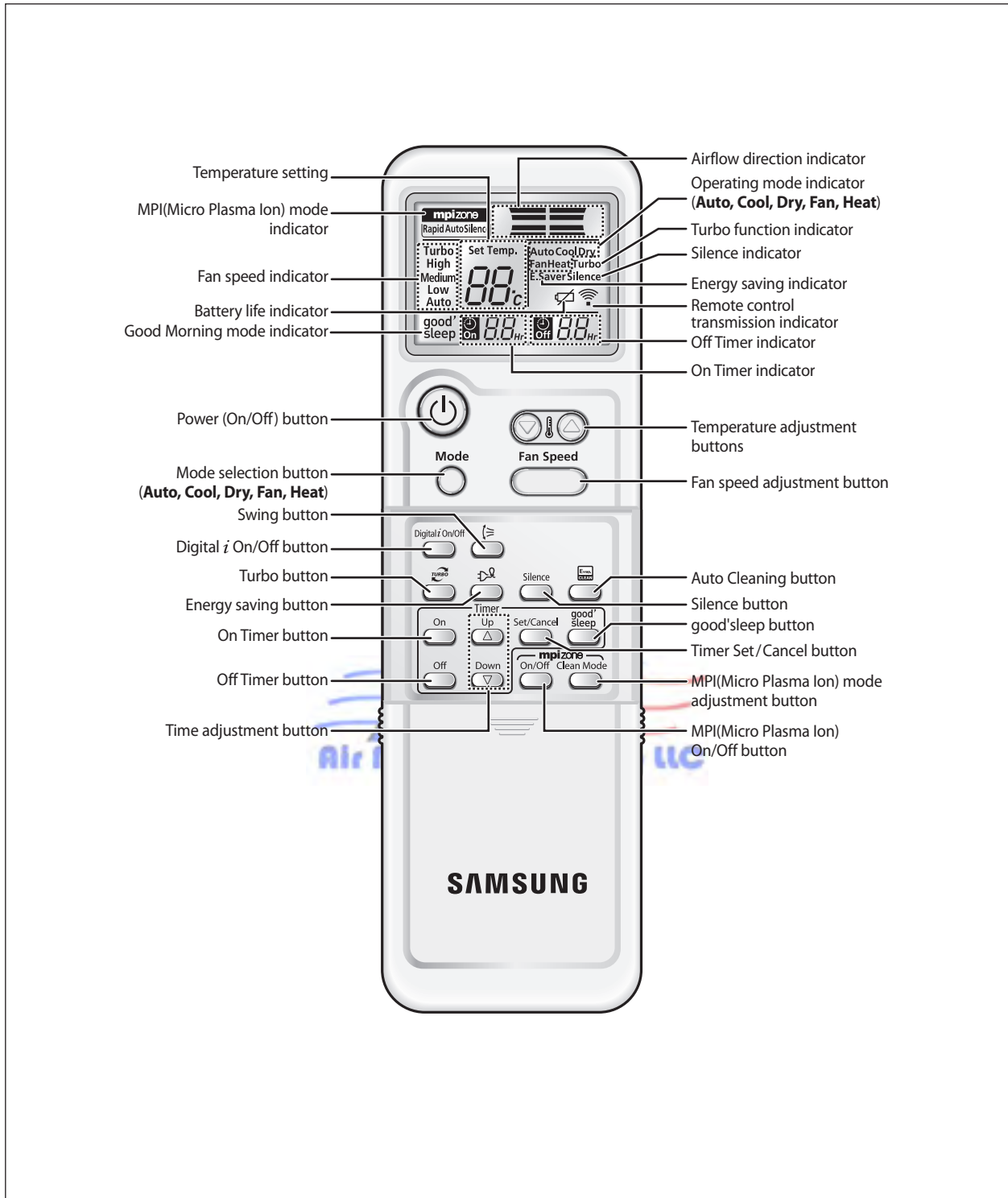



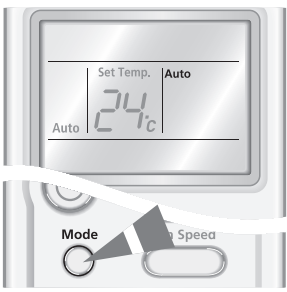

11-2 Wireless Remote Control-Buttons and Display

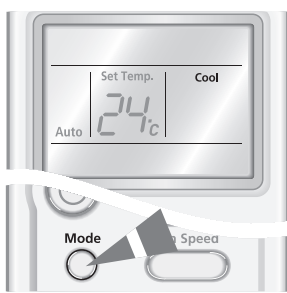

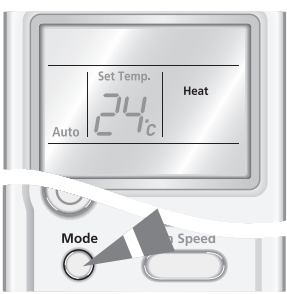

11-3 Main Function





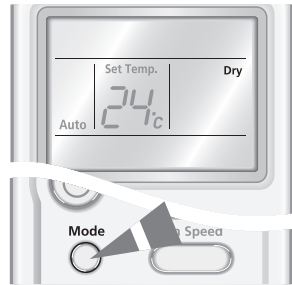

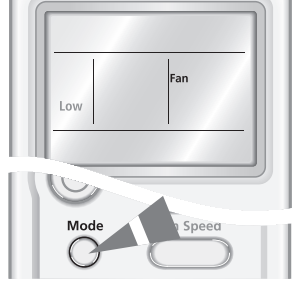
11-3-1 Basic Function

Mode	Explanation	Remark
<p>Auto Mode</p>	<p>Press the  button on the remote control until Auto is displayed.</p>	
<p>Cool Mode</p>	<p>Press the  button on the remote control until Cool is displayed.</p> <p>Press the  button to select the fan speed until the required setting is displayed.</p> <p>Auto → Low → Medium → High</p>	 
<p>Heat Mode</p>	<p>Press the  button on the remote control until Heat is displayed.</p> <p>Press the  button to select the fan speed until the required setting is displayed.</p> <p>Auto → Low → Medium → High</p>	 

Basic Function(cont.)

Mode	Explanation	Remark
Dry Mode	Press the  button on the remote control until Dry is displayed.	
Fan Mode	Press the  button on the remote control until Fan is displayed.	

11-3-2 Applied Function

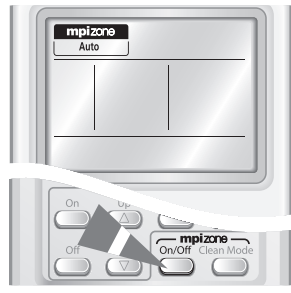
Mode	Explanation	Remark
good'sleep Mode	Press the  button. <ul style="list-style-type: none"> ◆ The timer indicator is displayed. ◆ The Off timer is blinking on the remote control. 	
Silence Mode	Press the  button.	
MPI Mode	Press the  button. <ul style="list-style-type: none"> ◆ The air conditioner starts up in MPI-Auto mode automatically. ◆ The MPI mode also runs when the air conditioner is turned on. ◆ By pressing the  button again, the MPI mode is canceled. 	

12. Troubleshooting

12-1 Items to be checked first

- The input voltage should be rating voltage $\pm 10\%$ range.
The air conditioner may not operate properly if the voltage is out of this range.
- Is the link cable linking the indoor unit and the outdoor unit linked properly?
The indoor unit and the outdoor unit shall be linked by 5 cables.
Check the terminals if the indoor unit and outdoor unit are properly linked by the same number of cables.
Otherwise the air conditioner may not operate properly.
- When a problem occurs due to the contents illustrated in the table below it is a symptom not related to the malfunction of the air conditioner.

No	Operation of air conditioner	Explanation
1	The OPERATION indication LED(BLUE) blinks when a power plug of the indoor unit is plugged in for the first time.	It indicates power is on. The LED stops blinking if the operation ON/OFF button on the remote control unit is pushed.
2	In a COOL operation mode, the compressor does not operate at a room temperature higher than the setting temperature that the INDOOR FAN should operate. [In case of heat pump model] In a HEAT operation mode, the compressor does not operate at a room temperature lower than the setting temperature that indoor fan should operate.	In happens after a delay of 3 minutes when the compressor is reoperated. The same phenomenon occurs when a power is on. As a phenomenon that the compressor is reoperated after a delay of 3 minutes, the indoor fan is adjusted automatically with reference to a temperature of the air blew.
3	Fan speed setting is not allowed in DRY mode.	The speed of the indoor fan is set to LL in DRY mode. Fan speed is selected automatically in AUTO mode.
4	Compressor stops operation intermittently in DRY mode.	Compressor operation is controlled automatically in DRY mode depending on the room temperature and humidity.
5	Timer LED(ORANGE) of the indoor unit lights up and the air conditioner does not operate.	Timer is being activated and the unit is in ready mode. The unit operates normally if the timer operation is cancelled.
6	The compressor stops intermittently in a COOL mode or DRY mode, and fan speed of the indoor unit decreases.	The compressor stops intermittently or the fan speed of the indoor unit decreases to prevent inside/outside air frozen depending on the inside/outside air temperature.
7	[In case of heat pump model] Compressor of the outdoor unit is operating although it is turned off in a HEAT mode.	When the unit is turned off while de-ice is activated, the compressor continues operation for up to 9 minutes(maximum) until the deice is completed.
8	[In case of heat pump model] The compressor and indoor fan stop intermittently in HEAT mode.	The compressor and indoor fan stop intermittently if room temperature exceeds a setting temperature in order to protect the compressor from overheated air in a HEAT mode.
9	[In case of heat pump model] Indoor fan and outdoor fan stop operation intermittently in a HEAT mode.	The compressor operates in a reverse cycle to remove exterior ice in a HEAT mode, and indoor fan and outdoor fan do not operate intermittently for within 20% of the total heater operation

12-2 Fault Diagnosis by Symptom

12-2-1 No Power (completely dead)-Initial diagnosis

1. Checklist :

- 1) Is input voltage normal?
- 2) Is AC power linked correctly?
- 3) Is input voltage of DC regulator IC KA7805 (IC02) normal? (11VDC-12.5VDC)
- 4) Is output voltage of DC regulator IC KA7805 (IC02) normal? (4.5VDC-5.5VDC)

2. Troubleshooting procedure

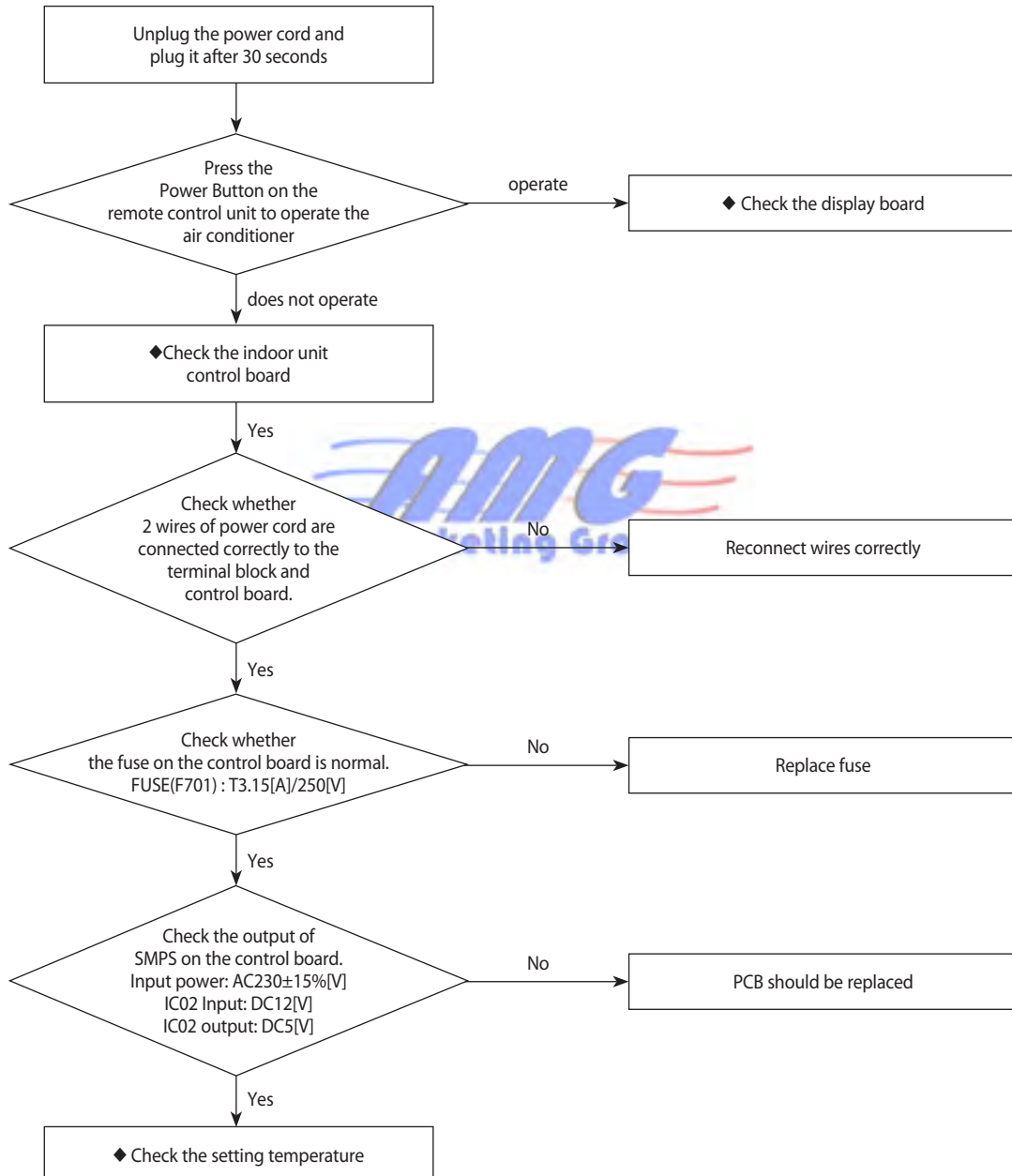

12-2-2 The Outdoor unit power supply error

1. Checklist :

- 1) Are the input power voltage and the power connection correct?
- 2) Is there no Fuse short in the indoor unit and outdoor unit?
- 3) Is the cable connected correctly between the indoor unit and outdoor unit in order.
- 4) Is the wire connected correctly to the terminal block of the indoor unit and outdoor unit?

2. Troubleshooting procedure

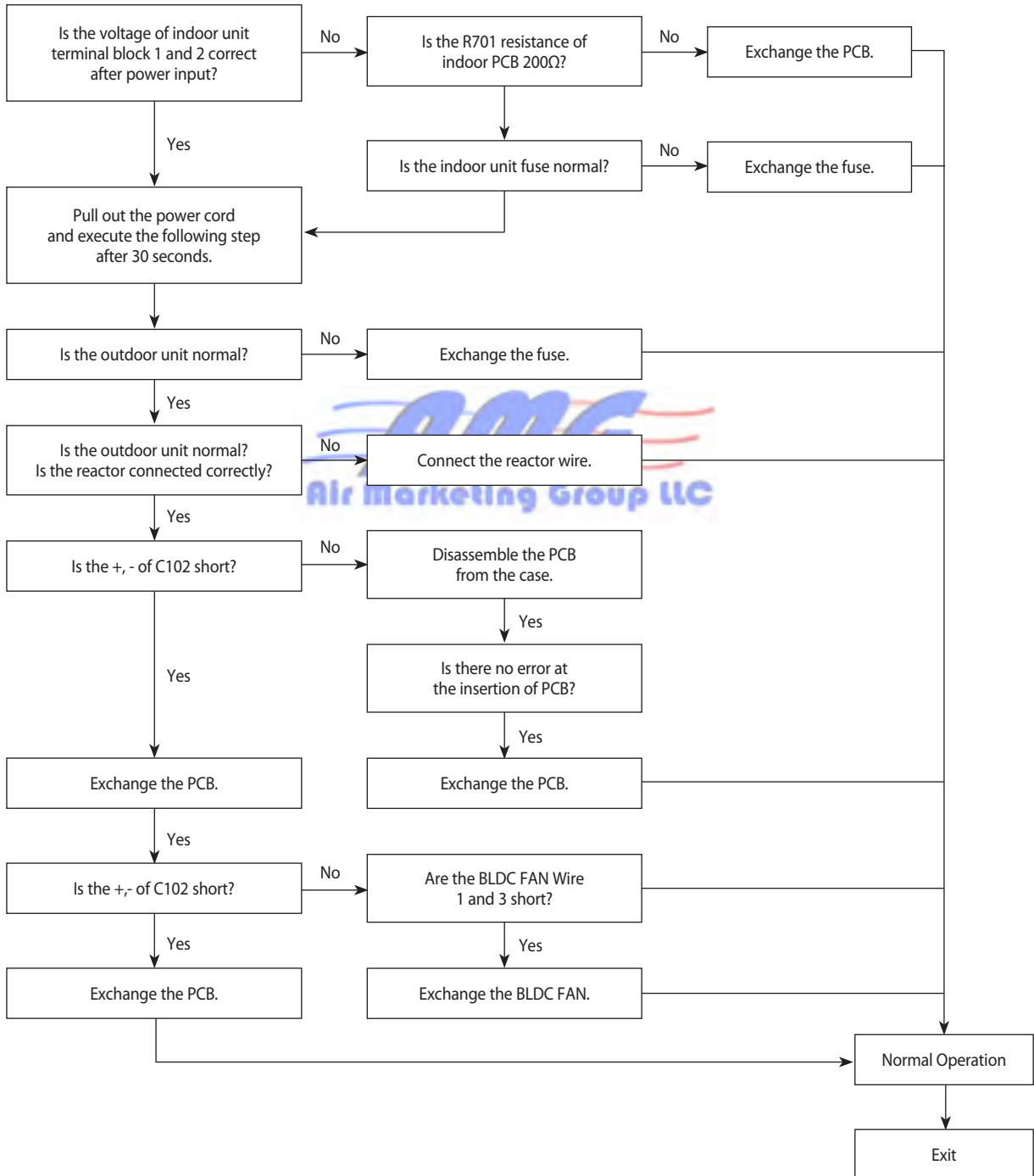

12-2-3 When the Up/Down Louver Motor Does Not Operate. (Initial Diagnosis)

1. Checklist :
 - 1) Is input voltage normal?
 - 2) Is the Up/Down louver motor properly connected with the connector (CN61)?
2. Troubleshooting procedure

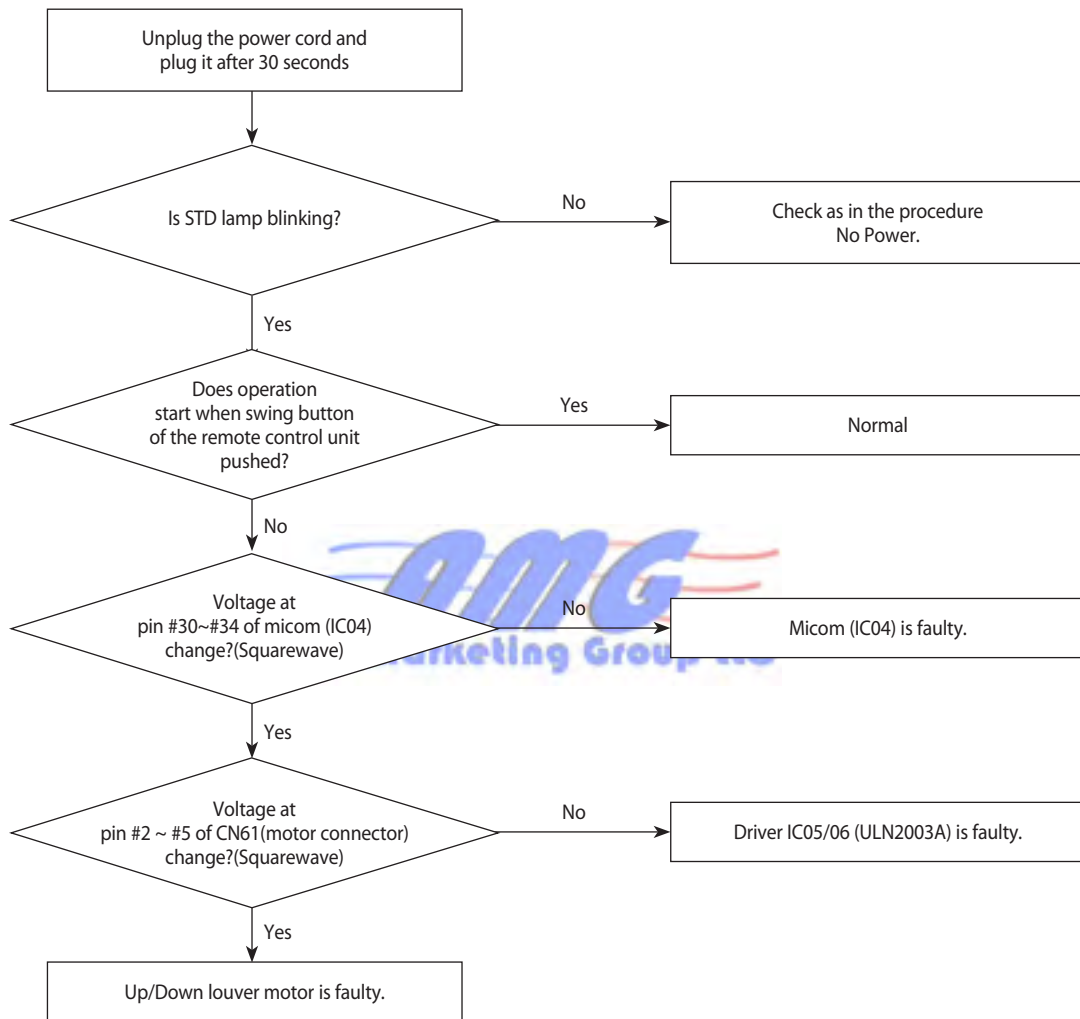

12-2-4 The Outdoor unit Fan error

1. Checklist :

- 1) Are the input power voltage and the power connection correct?
- 2) Is the motor wire connected to the outdoor PCB correctly?
- 3) Is there no assembly error or none-assembly in the terminal of motor wire connector?
- 4) Is there no obstacle at the surrounding of motor and propeller?

2. Troubleshooting procedure

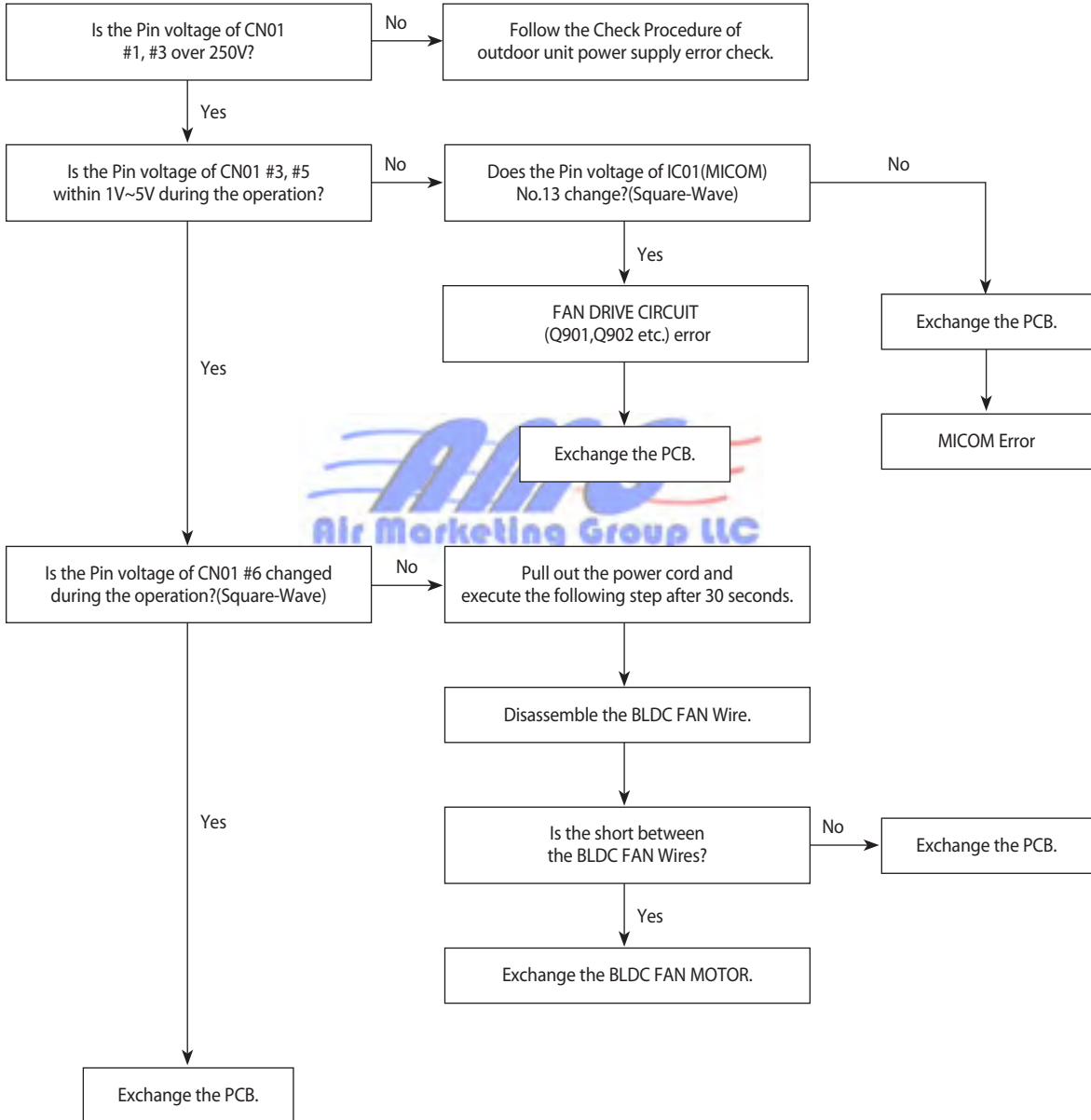

12-2-5 Total current Trip error

1. Checklist :

- 1) Is the input power voltage proper?
- 2) Is the refrigerant charged properly?
- 3) Does the compressor rotate normally? (Reverse rotation, Locking etc.)
- 4) Dose the outdoor fan operate normally? (Fan propeller loss, Motor error etc.)
- 5) Is the installation condition of outdoor unit good? (Piping, Space etc.)
- 6) Is there no ventilation obstruction at the surrounding of outdoor? (Outdoor unit cover, Fan front obstruction etc.)

2. Troubleshooting procedure

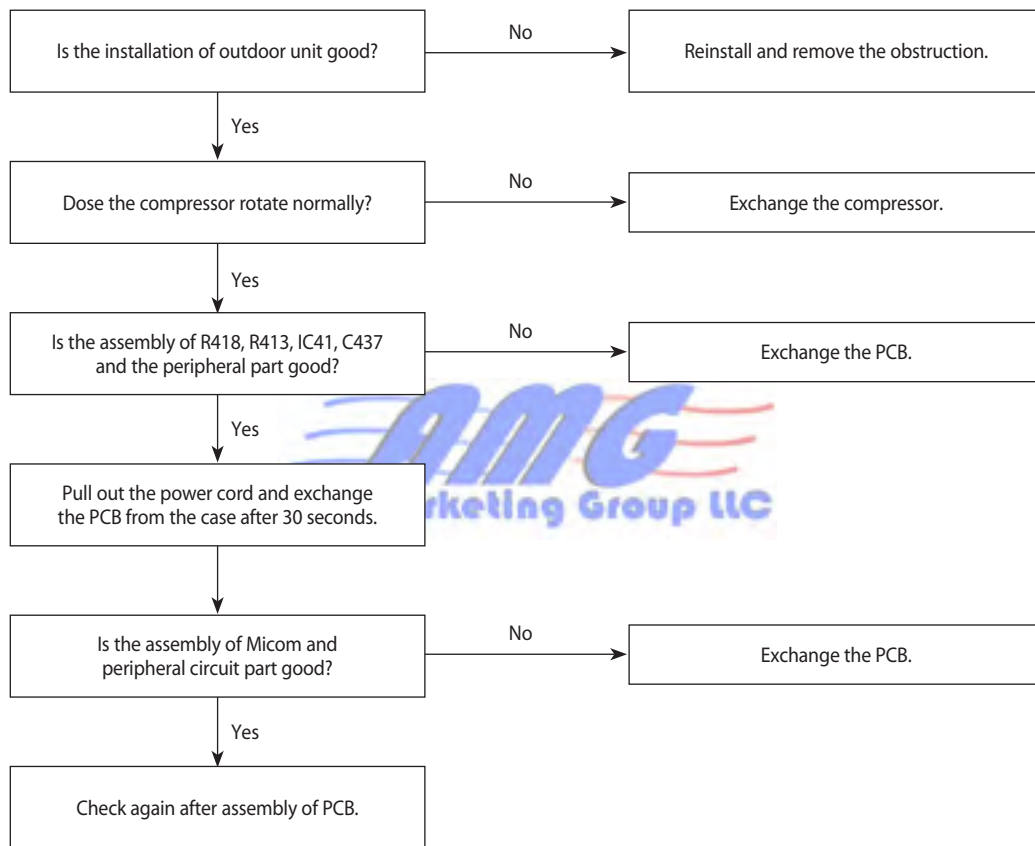

12-2-6 In case of heating at the cooling mode or cooling at the heating mode

1. Troubleshooting procedure

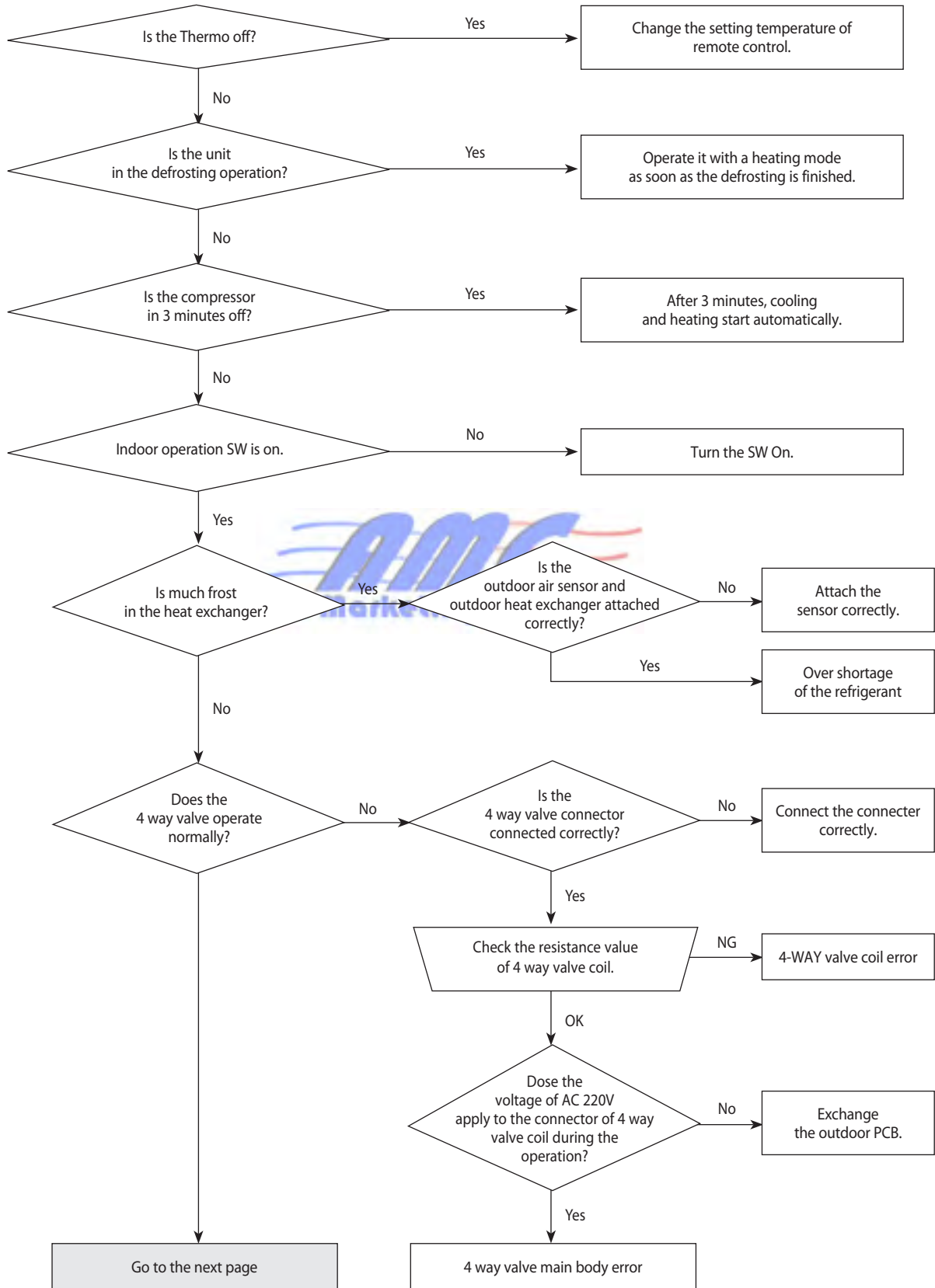

In case of heating at the cooling mode or cooling at the heating mode(cont.)

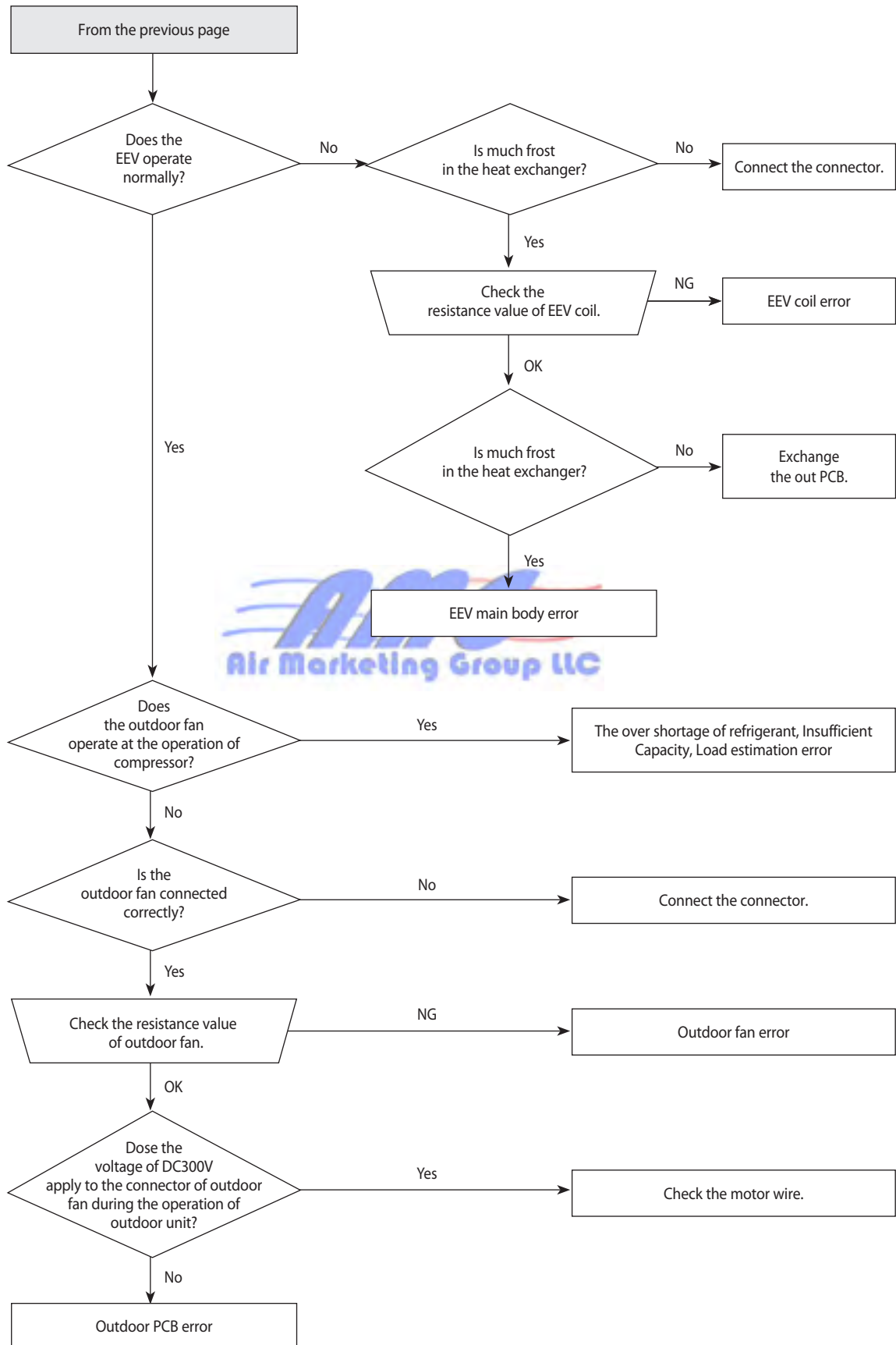

12-2-7 Outdoor temperature sensor error

1. Checklist :

- 1) Is the sensor connector connected correctly?
- 2) Is the sensor placed correctly?
- 3) Does the both terminal of sensor satisfy the resistance value in accordance with temperature?
- 4) Is the resistance value of sensor connection pull_up correct?

2. Troubleshooting procedure

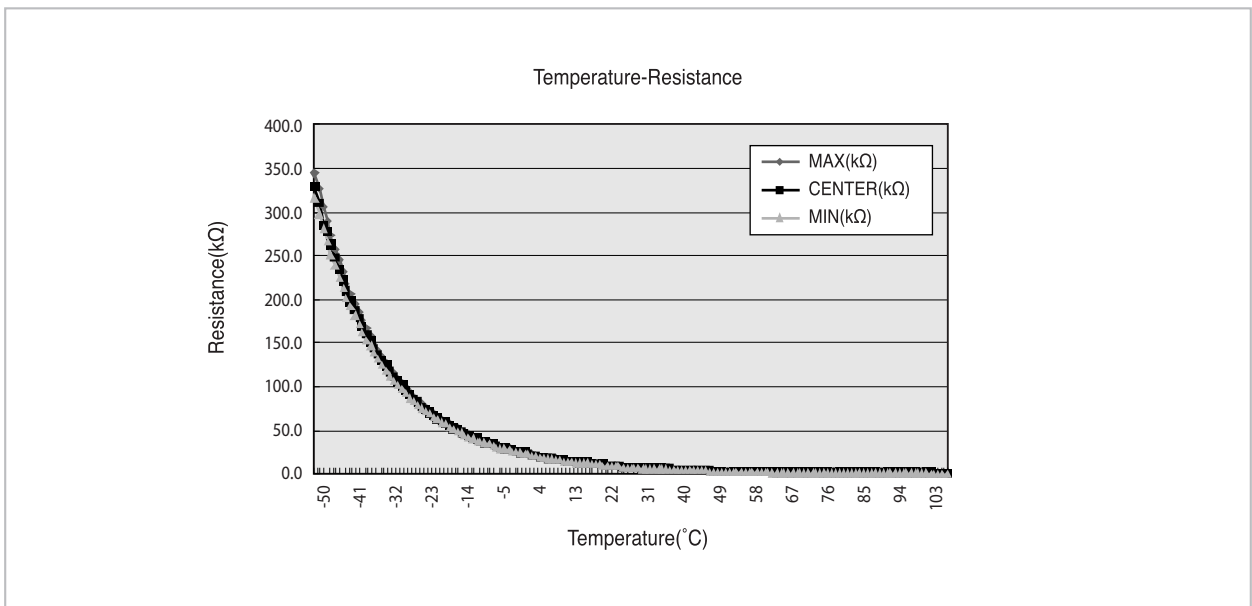
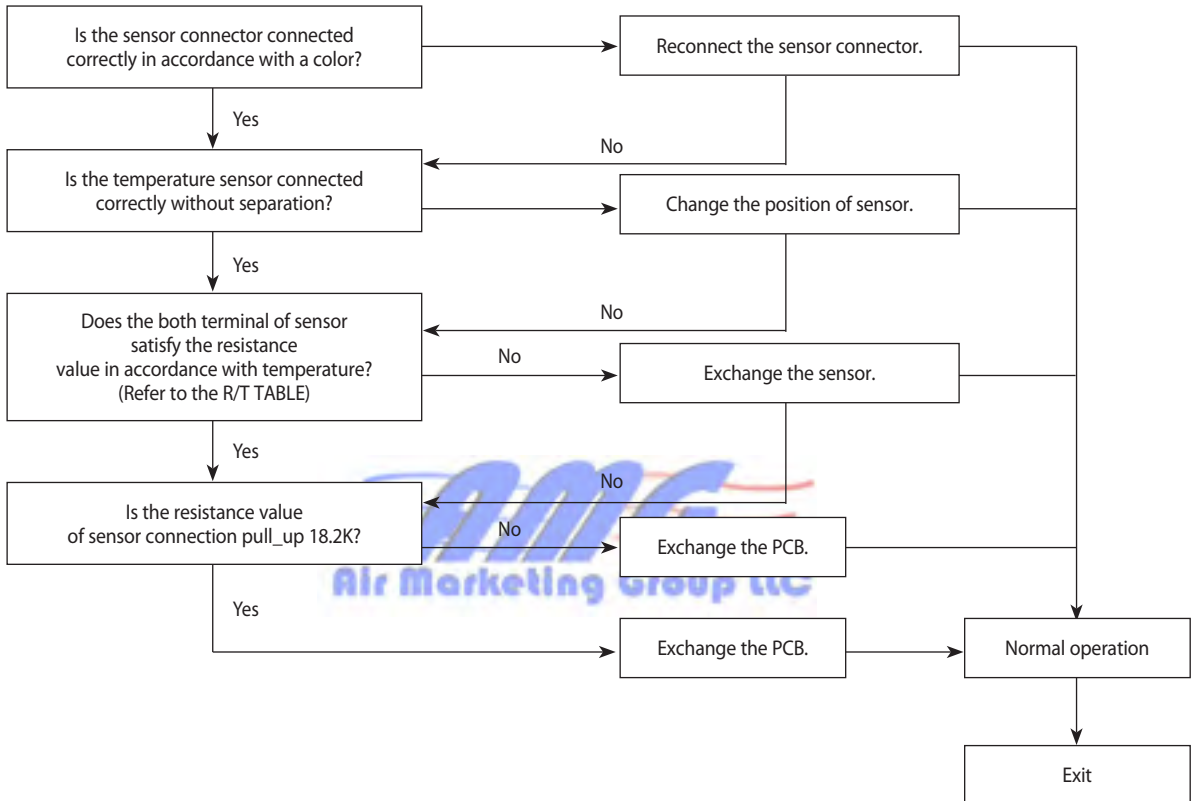

12-2-8 Discharge temperature sensor error

1. Checklist :

- 1) Is the sensor connector connected correctly?
- 2) Is the sensor placed correctly?
- 3) Does the both terminal of sensor satisfy the resistance value in accordance with temperature?
- 4) Is the resistance value of sensor connection pull_up correct?

2. Troubleshooting procedure

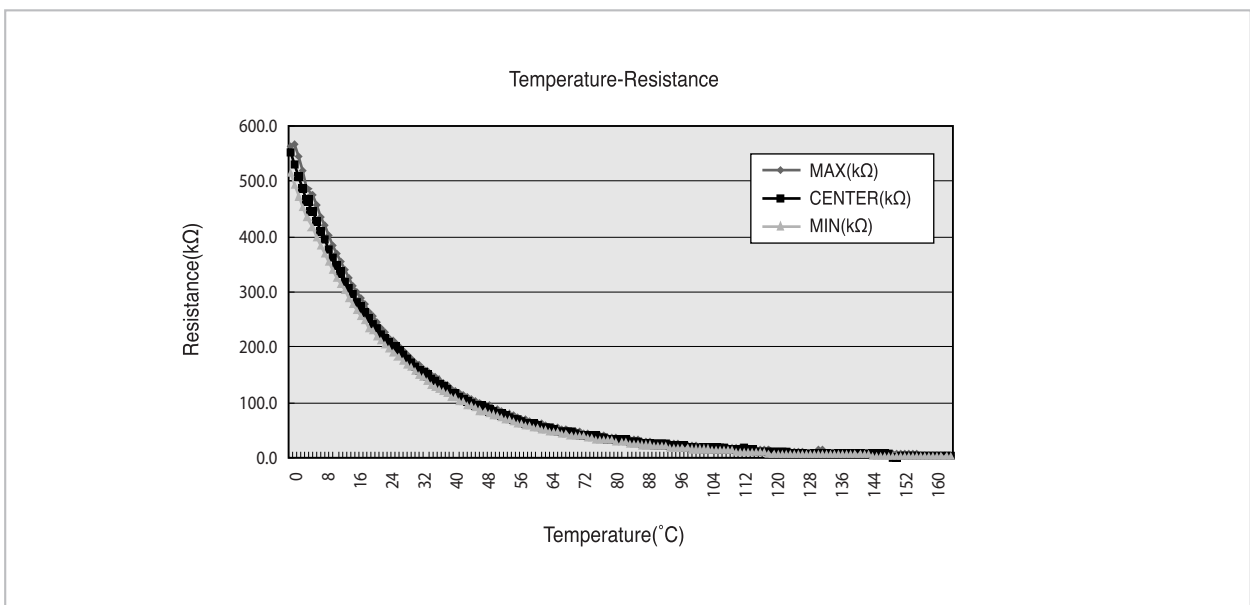
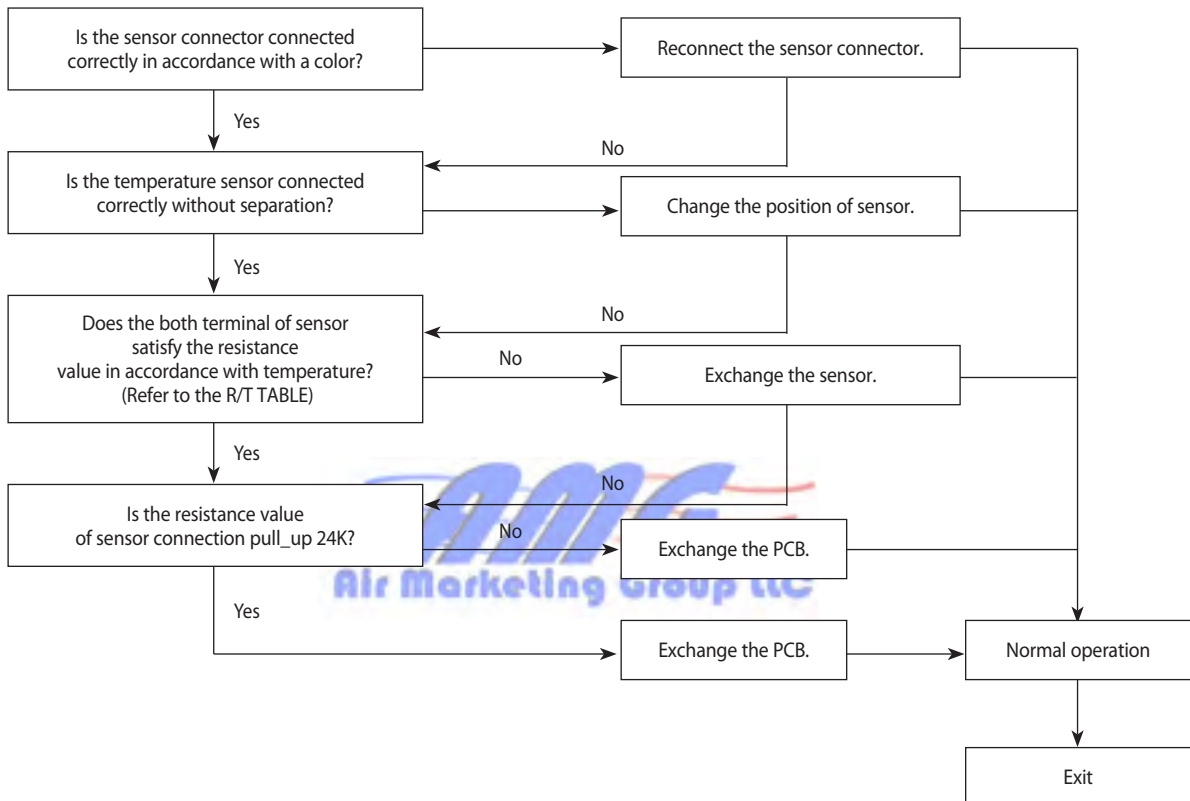

12-2-9 Coil temperature sensor error

1. Checklist :

- 1) Is the sensor connector connected correctly?
- 2) Is the sensor placed correctly?
- 3) Does the both terminal of sensor satisfy the resistance value in accordance with temperature?
- 4) Is the resistance value of sensor connection pull_up correct?

2. Troubleshooting procedure

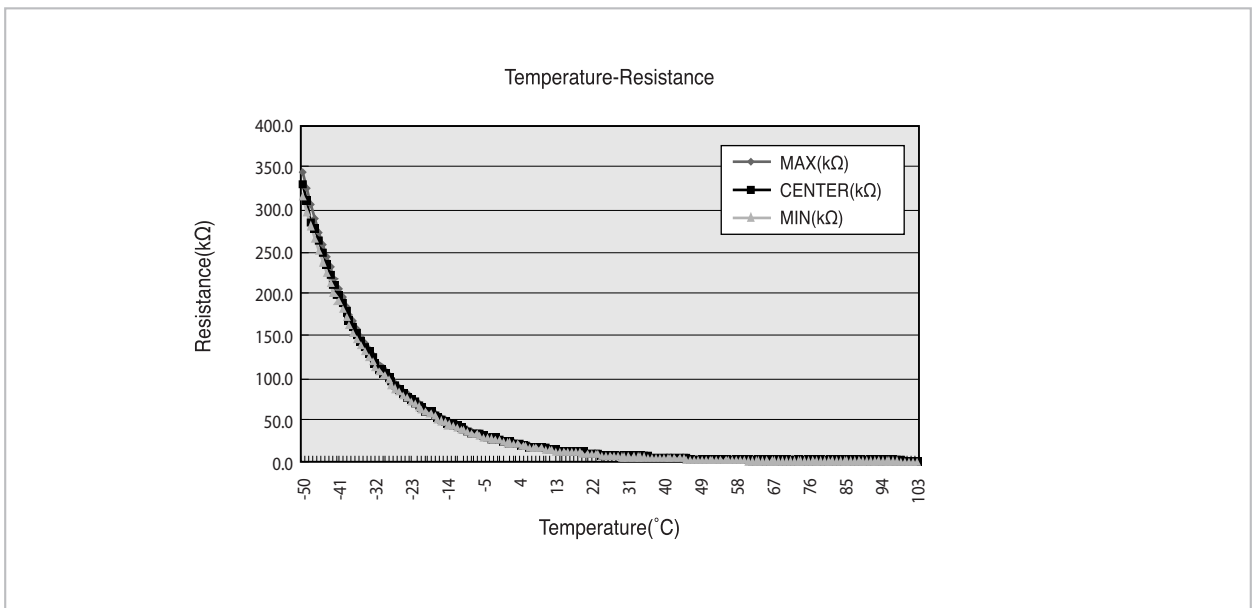
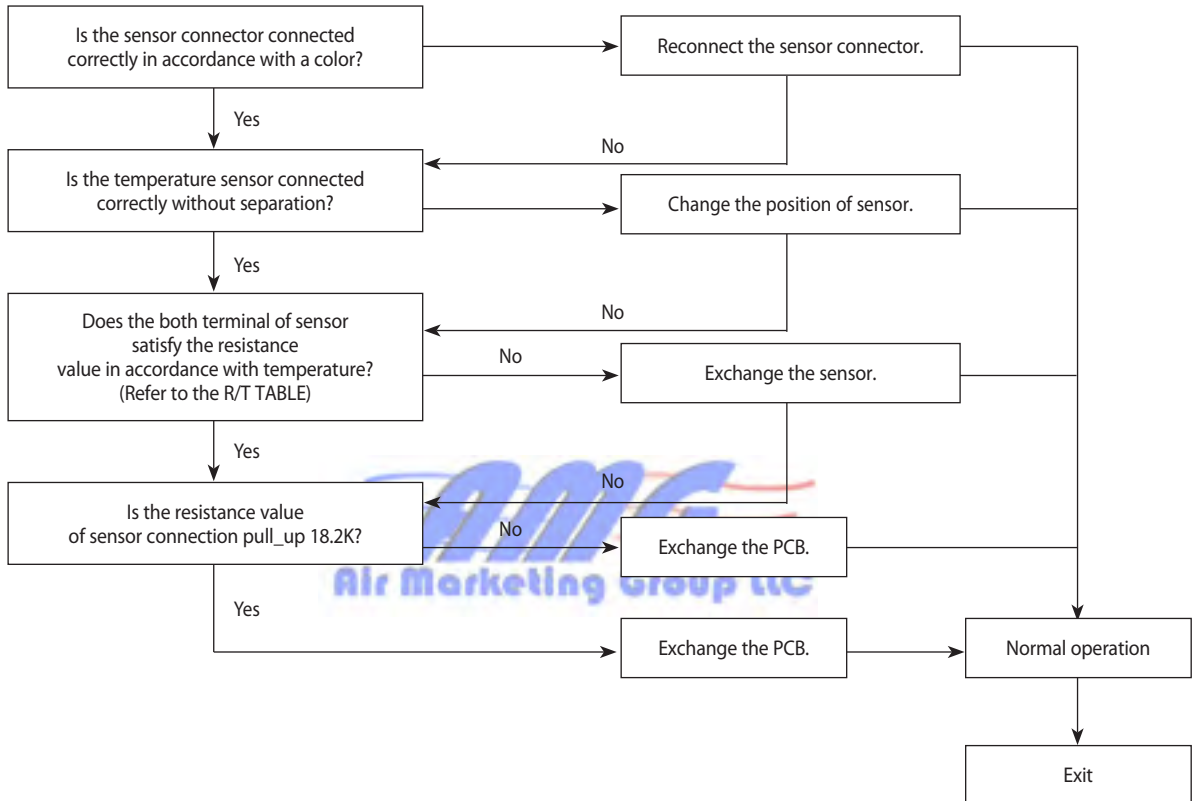

12-2-10 Fan error

1. Checklist :

- 1) Isn't the fan locked?
- 2) Is the sensor placed correctly?
- 3) Does the both terminal of sensor satisfy the resistance value in accordance with temperature?
- 4) Is the resistance value of sensor connection pull_up correct?

2. Troubleshooting procedure

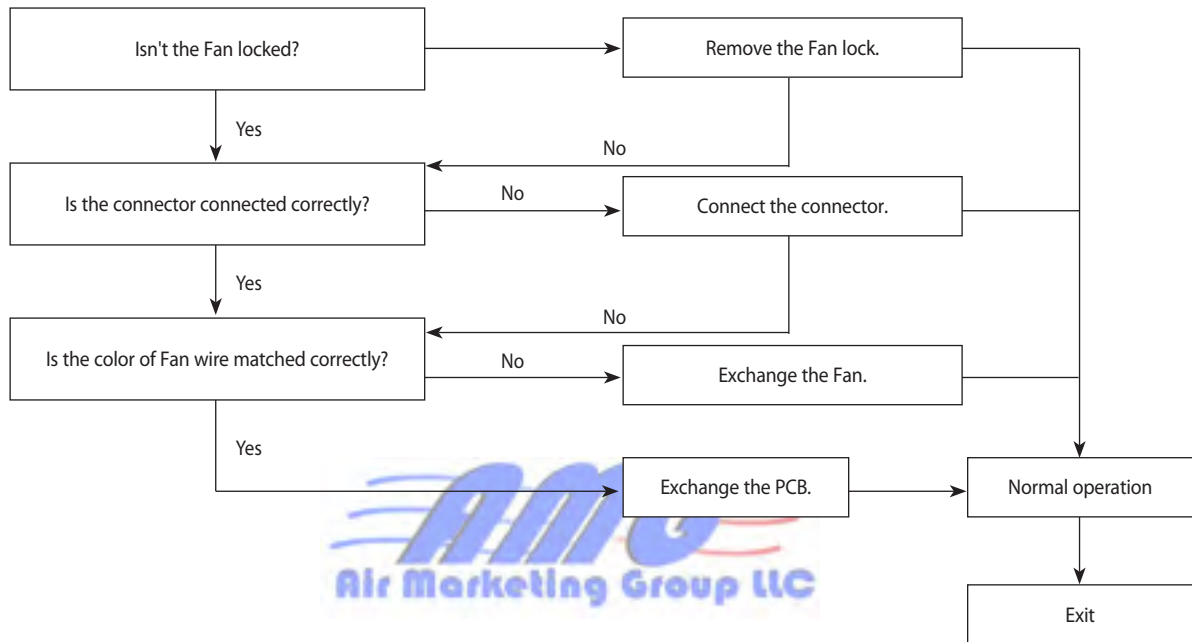

12-2-11 DC-Link voltage sensor error

1. Checklist :

- 1) Is the voltage of indoor unit terminal block 1, 2 correct after power supply?
- 2) Is the capacitor(C101, C102, C103) for DC-Link assembled in accordance the specification?
- 3) Are R112, R113, R114 470 Kohm?
- 4) Is R115 14.3Kohm?

2. Troubleshooting procedure

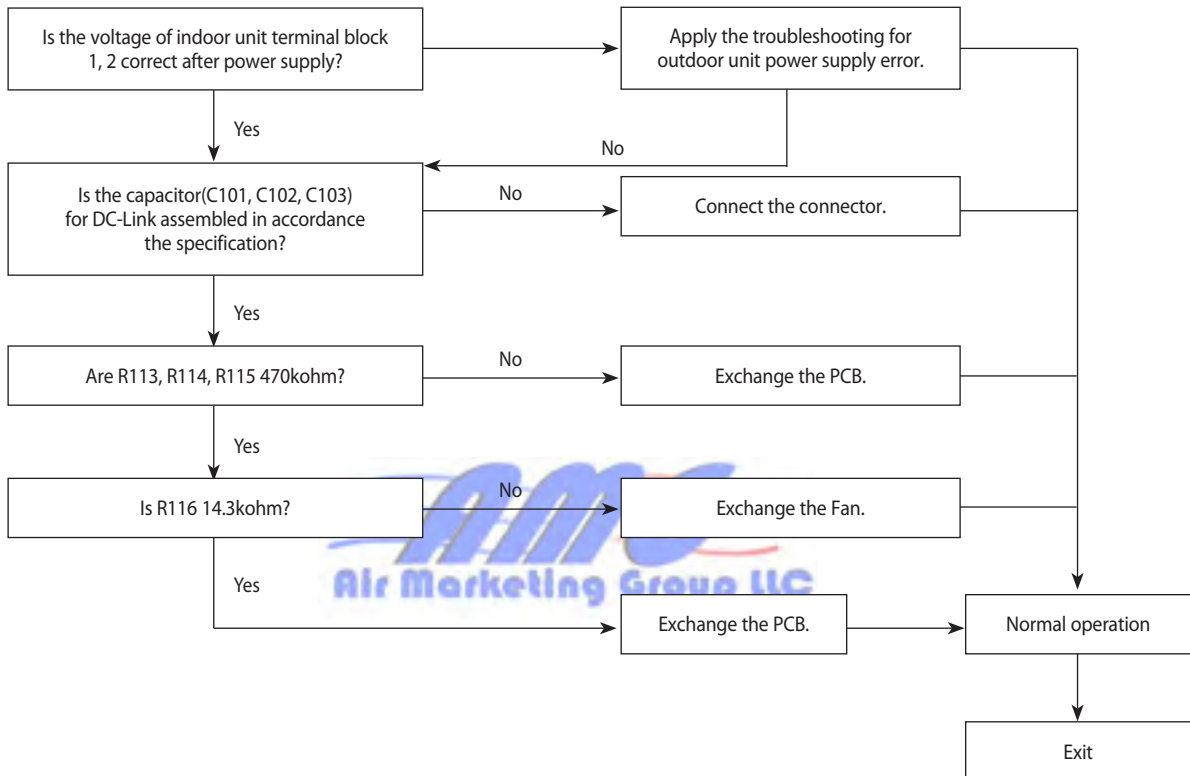

12-2-12 O.C.(Over Current) error

1. Checklist :

- 1) Is the Shunt resistance value correct?
- 2) Is the condition of surrounding temperature abnormal overload?
- 3) Is there any problem as like the temperature sensor separation or measurement value error?
- 4) Is the interphase resistance of compressor normal?

2. Troubleshooting procedure

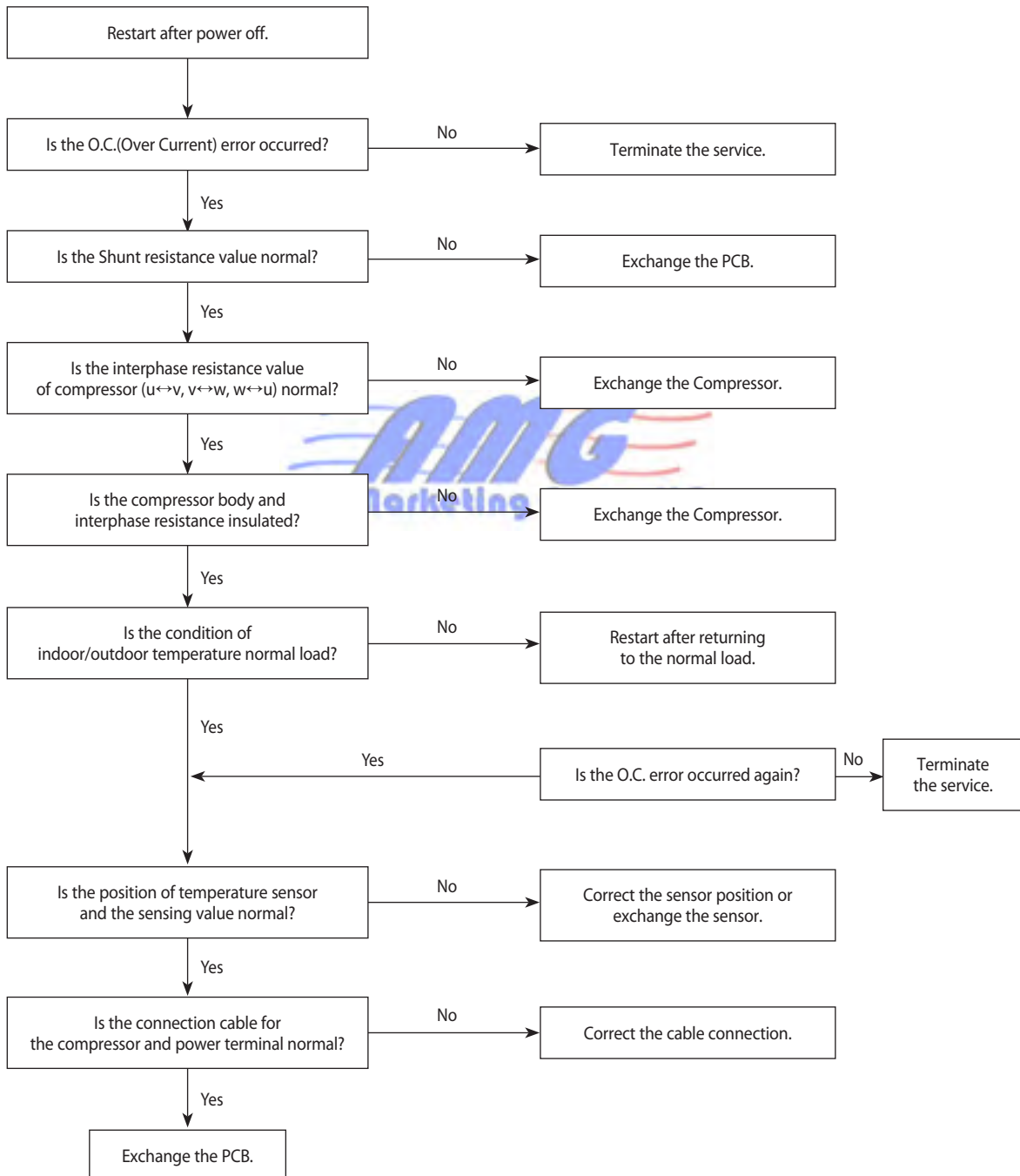

12-2-13 Communication error

1. Checklist :

- 1) Is the communication cable between the indoor unit and outdoor unit connected correctly?
- 2) Isn't the power cable and communication cable error?

2. Troubleshooting procedure

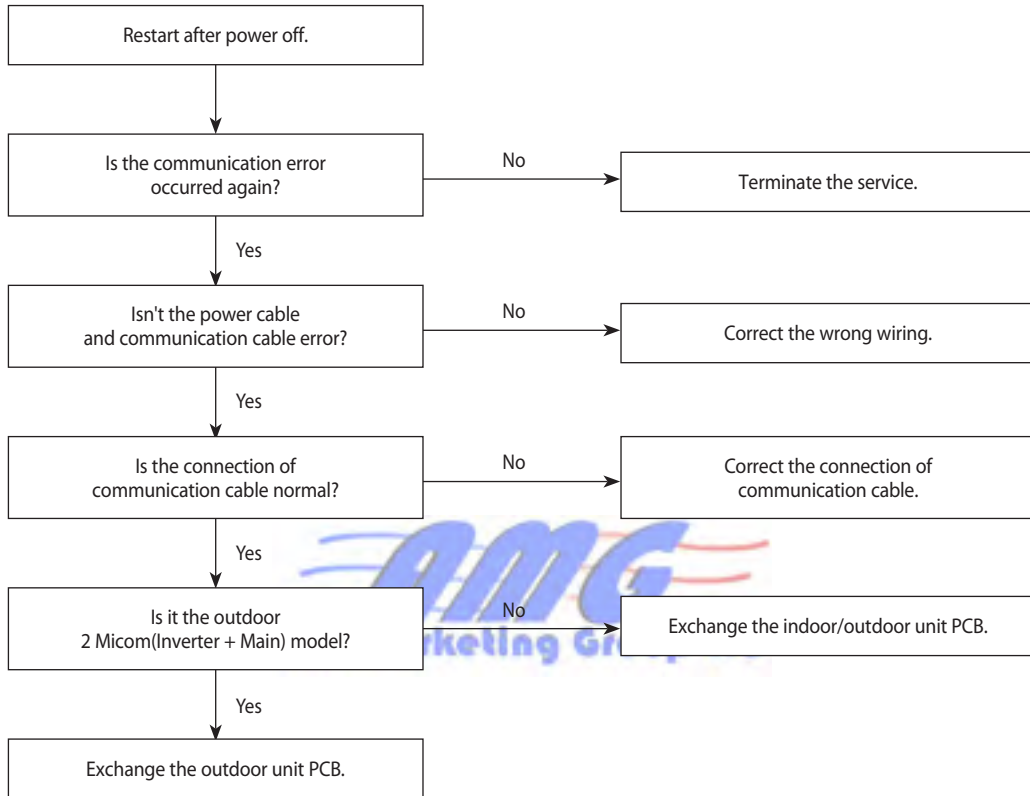

12-2-14 Compressor start error

1. Checklist :
 - 1) Is the connection of cable for the compressor and power?
 - 2) Is the interphase resistance of compressor normal?
2. Troubleshooting procedure

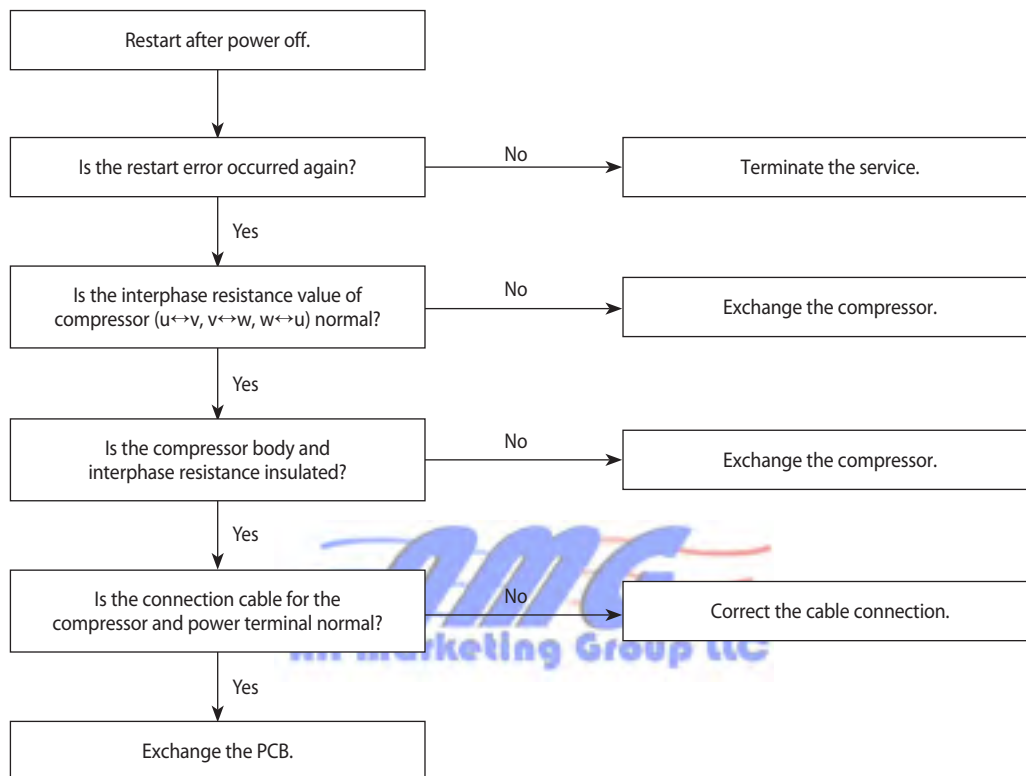

12-2-15 Compressor lock error

1. Checklist :
 - 1) Is the connection of cable for the compressor and power?
 - 2) Is the interphase resistance of compressor normal?
2. Troubleshooting procedure

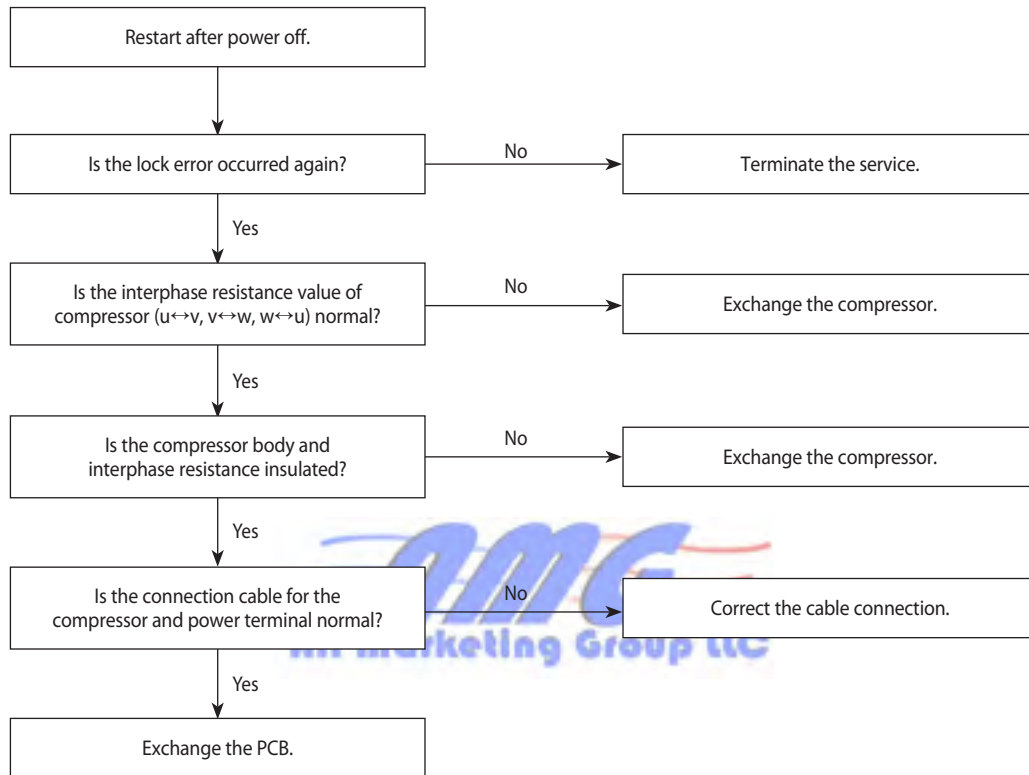

12-2-16 DC Link Over voltage/ Low voltage error

1. Checklist :

- 1) Is the power voltage normal?
- 2) Is the voltage of front and back terminal of indoor(outdoor) power relay normal?
- 3) Is the resistance value for DC Link voltage detection NORMAL?
- 4) Is the resistance value of DC Link discharge normal?
- 5) Is the appearance of DC Link Capacitor normal?

2. Troubleshooting procedure

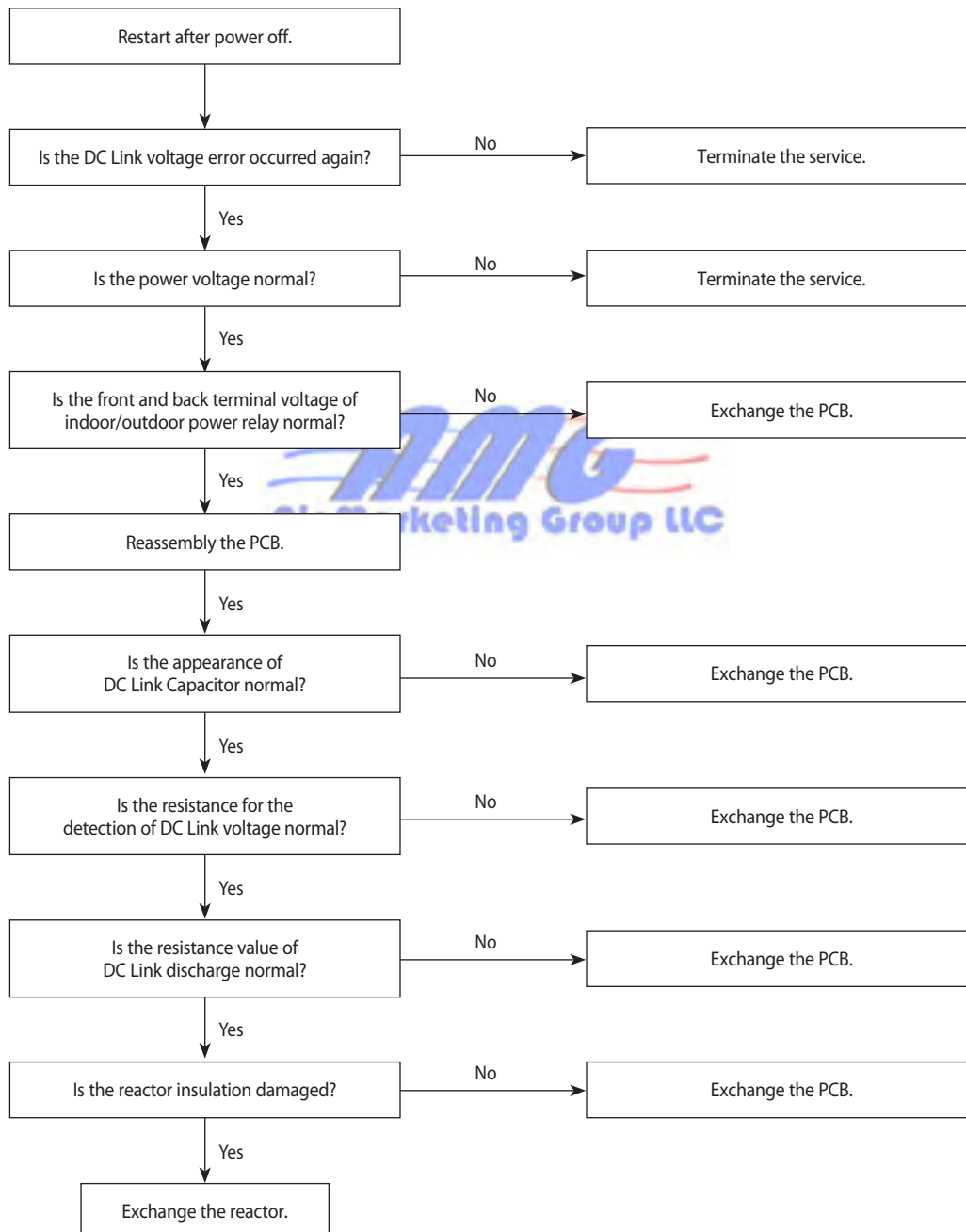

12-2-17 When the remote control is not receiving

1. Check if the connector was normally assembled.
2. Put the set in operation and check the voltage of No. 15(+) and No. 16(-) of the main PCB CN91 while operating the remote control. When the voltage descends below 3V, the assembly module PCB is normal and the main PCB is poor. Then replace the main PCB.
3. Replace the assembly display PCB because the module PCB is poor if the voltage between No. 15~16 of CN91 maintains 5V after the remote control starts operation.

12-2-18 The others

1. AC Line Zero Cross Signal OUT
 - Check the assembly condition of peripheral part of IC21, ZD21, ZD20 and D200 on the PCB.
2. Capacity miss match
 - Check again the indoor unit option code.

12-3 PCB Inspection Method

12-3-1 Pre-inspection Notices

1. Check if you pulled out the AC power plug when you eliminate the PCB or front panel.
2. Don't hold the PCB side not impose excessive force on it to eliminate the PCB.
3. Don't pull the lead wire but hold the whole housing to connect or disconnect a connector to the PCB.
4. In case of outdoor PCB disassembly, check first the complete discharge of condenser (C103) after 30 seconds power off.

12-3-2 Inspection Procedure

1. Check connector connection and peeling of PCB or bronze coating pattern when you think the PCB is broken.
2. The PCB is composed of the 3 parts.
 - Indoor Main PCB Part : MICOM and surrounding circuit, relay, room fan motor driving circuit and control circuit, sensor driving circuit, power circuit of DC12V and DC5V, and buzzer driving circuit.
 - Display part : LED lamp, Switch, Remocon module
 - Outdoor Main PCB part : MICOM and surrounding circuit. IPM and PFC circuit and control circuit.
 - EMI PCB Part : Line filter and Noise Capacitor, Varistor

12-3-3 Indoor Detailed Inspection Procedure

No	Procedure	Inspection Method	Cause
1	Plug out and pull the PCB out of the electronic box. Check the PCB fuse.	1) Is the fuse disconnected?	<ul style="list-style-type: none"> • Over current • Indoor Fan Motor Short • AC Part Pattern Short of the MAIN PCB
2	Supply power. If the operating lamp twinkles at this time, the above 1)~3) have no relation.	Checking the power voltage.	
		1) Is the DB71 input voltage AC200V~AC240V?	<ul style="list-style-type: none"> • Power Cord is fault, Fuse open. Wrong Power Cable Wiring, AC Part is faulty.
		2) Is the voltage between both terminals of the C104 on the 2 nd side of the transformer DC12V $\pm 0.5V$?	<ul style="list-style-type: none"> • Switching Trans or Power Circuit is faulty
3	Press the ON/OFF button.	Checking the power voltage.	
		1) Is the voltage over AC180V being imposed on terminal #3 and #5 of the fan motor connector(CN72)?	<ul style="list-style-type: none"> • Relay(RY71) Coil Disconnection, IC05 is faulty
		2) Check the voltage of both terminals of terminal block 1 and N(1) after 3 minute operation.: AC220V	<ul style="list-style-type: none"> • Relay(RY71) Contact is faulty
4	Press the ON/OFF button. 1. FAN Speed [High] 2. Continuous Operation	1) Is the voltage over AC180V being imposed on terminal #3 and #5 of the fan motor connector(CN72)?	<ul style="list-style-type: none"> • Fan Motor of the indoor is faulty
		2) The fan motor of the indoor unit doesn't run.	<ul style="list-style-type: none"> • Fan Motor Connector(CN72) is faulty
		3) The power voltage between terminal #3 and #5 of the connector(CN72) is 0V.	<ul style="list-style-type: none"> • ASS'Y Main PCB is faulty • Connection is faulty

12-3-4 Outdoor Detailed Inspection Procedure

No	Procedure	Inspection Method	Cause
1	Wait 30 seconds over after disconnecting the power cable Check the outdoor PCB.	1) Is C101 discharged? 2) Is the resistance of both terminals of C101 opened? 3) Is the fuse of EMI PCB normal? 4) Is the reactor wire connected?	<ul style="list-style-type: none"> • Over Current • Inner short of PCB • BLDC FAN Motor Error
2	Check the Outdoor unit PCB.	1) Is R701 200ohm? 2) Does ry74 operate normally? (IC05 & 16:0V, 1:5V) 3) Is the fuse(F701) normal? 4) Is the Sub PCB assembled normally?	<ul style="list-style-type: none"> • Outdoor PCB Error • SUB Relay(RY74) Error • IC05 Error • Indoor PCB Error
3	Check the LED lighting after power supply.	1) Normal: Red: Light On, Green: Flickering, Yellow: Light Off? 2) Is the voltage of C101 250V over? 3) Is the input of IC19 8V, and the output 5V? 4) Recheck after disassembling BLDC FAN Wire.	<ul style="list-style-type: none"> • Inner short of outdoor PCB • Wrong assembly of outdoor PCB • BLDC FAN Error
4	Check the condition of indoor & outdoor connection cable.	1) Is the green LED light on once per second? 2) Is the indoor & outdoor connection cable connected in order? 3) Is the grounding wire connected to the both of indoor & outdoor unit? 4) Is the voltage of terminal block N(1), 225V?	<ul style="list-style-type: none"> • Wrong connection of Indoor/Outdoor wiring • Wrong assembly of outdoor communication circuit
5	Check the Comp Wire.	1) Is it connected red, blue, and yellow in order in counterclockwise. 2) Are the valve and its installation condition good? 3) Is the installation condition of outdoor unit?	<ul style="list-style-type: none"> • Wrong assembly • Installation condition is bad.
6	Check the BLDC Fan.	1) Is CN01 1, 3 over 250V? 2) Is CN01 3, 5 within 1V~5V? 3) Is the voltage of CN01 6 changed? 4) Is the resistance of BLDC Motor 1, 3 opened after power off?	<ul style="list-style-type: none"> • Outdoor PCB Error • BLDC Motor Error

12-4 Main Part Inspection Method

Part	Breakdown Inspection Method										
Room Temperature Sensor	Measure resistance with a tester										
	Normal	At the normal temperature $37k\Omega \sim 8.3k\Omega (-7^{\circ}C \sim +30^{\circ}C)$ *Refer to Table 12-3-4.									
	Abnormal	$\infty, 0\Omega \dots$ Open or Short									
Room Fan Motor	Measure the resistance between terminals of the connector (CN72) with a tester.										
	Normal	At the normal temperature ($10^{\circ}C \sim 30^{\circ}C$)									
		<table border="1"> <thead> <tr> <th>Compare terminal</th> <th>Resistance</th> <th>Remark</th> </tr> </thead> <tbody> <tr> <td>Yellow, Blue</td> <td>$404.4\Omega \pm 10\%$</td> <td>Main</td> </tr> <tr> <td>Yellow, Red</td> <td>$340\Omega \pm 10\%$</td> <td>Sub</td> </tr> </tbody> </table>	Compare terminal	Resistance	Remark	Yellow, Blue	$404.4\Omega \pm 10\%$	Main	Yellow, Red	$340\Omega \pm 10\%$	Sub
		Compare terminal	Resistance	Remark							
Yellow, Blue	$404.4\Omega \pm 10\%$	Main									
Yellow, Red	$340\Omega \pm 10\%$	Sub									
Abnormal	$\infty, 0\Omega \dots$ Open or Short										
Stepping Motor	Measure the resistance between the red wire and each terminal wire with a tester.										
	Normal	About 300Ω at the normal temperature ($20^{\circ}C \sim 30^{\circ}C$)									
	Abnormal	$\infty, 0\Omega \dots$ Open or Short									



13. Block Diagram

13-1 Indoor Unit

* : OPTION

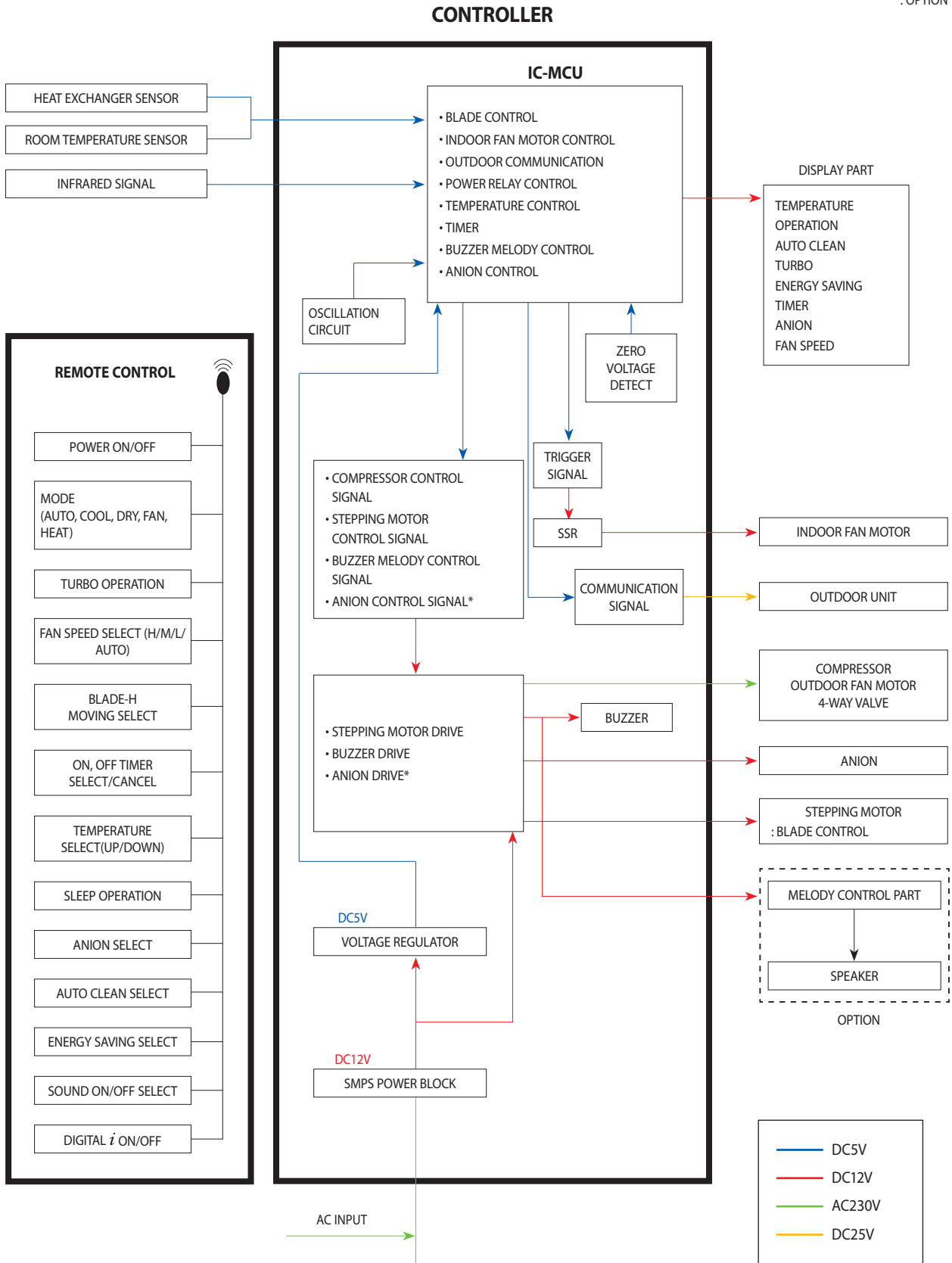

13-2 Outdoor Unit

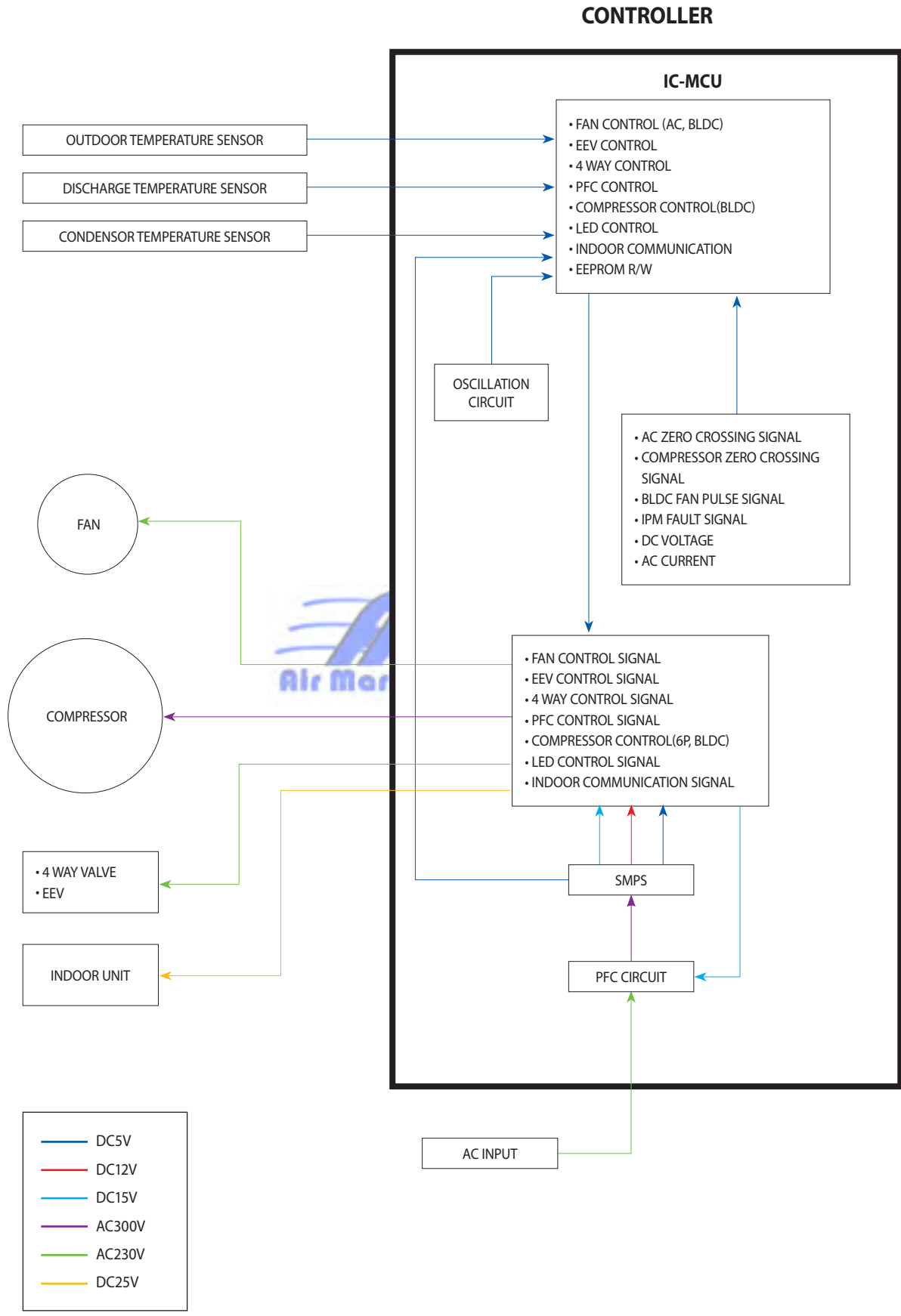

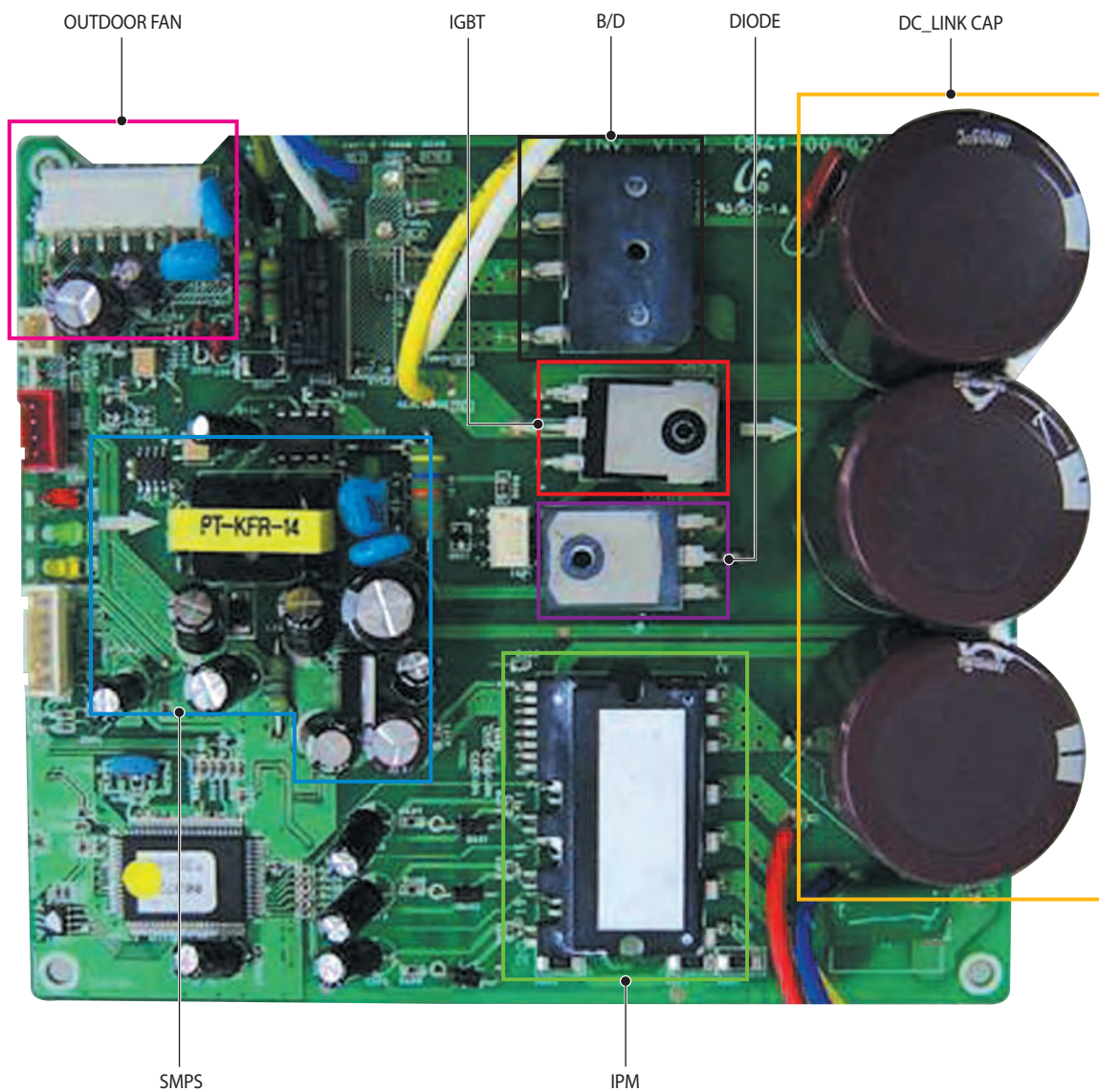

14. Reference Sheet

14-1 Index for Model Name

* Project model code for overseas from 2007(For RAC Export Models)

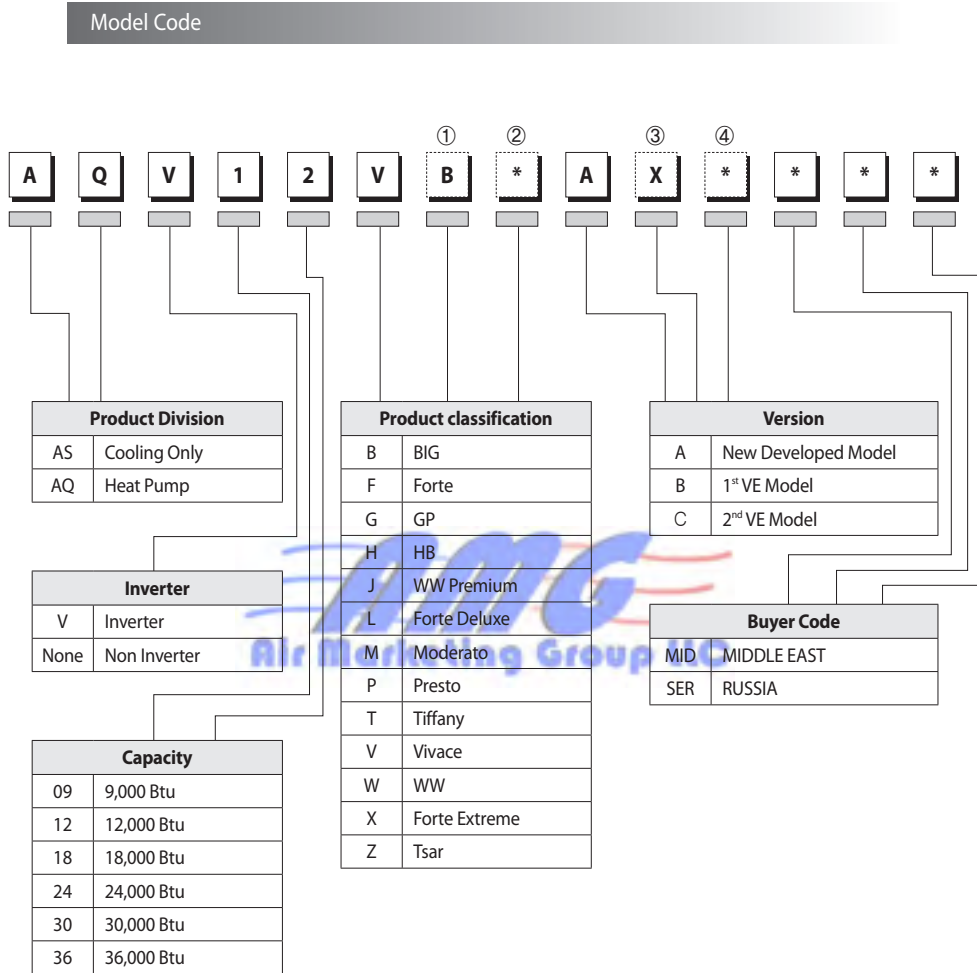

- ①: Use the " ① " digit for Grille Color deviation.
: Don't use the digit for Basic White model.
ex) Silver : S, Black : B, White : W, etc.
- ②: Use the " ② " digit for Electric Source deviation.
: Only for "XAP", "XAX", "GEM" Buyer.
- ③: Use the " ③ " digit for classification between indoor and outdoor.
Indoor ⇒ "N" & Outdoor ⇒ "X".
- ④: Use the " ④ " digit for KD models.
"CKD" ⇒ "1" & "SKD" ⇒ "2".

□ Except the RAC Export Models for China.

14-2 Low Refrigerant Pressure Distribution

Note : • Please measure the refrigerant pressure after the air conditioner operates on testing cooling mode during more than 10 minutes.

- Indoor Temp. Variation : 20°C ~ 32°C
- Outdoor Temp. Variation : -5°C ~ 45°C

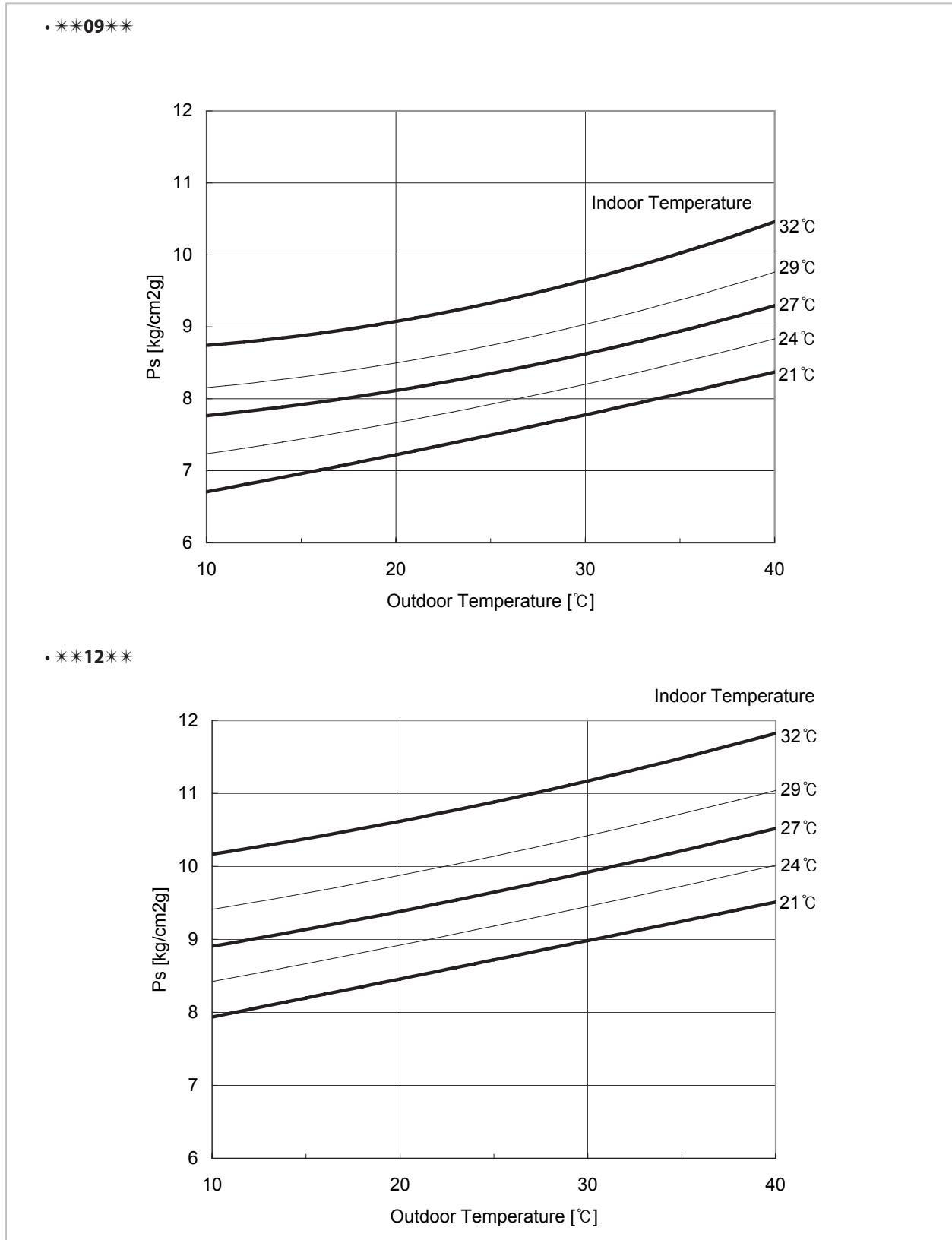

14-3 Pressure & Capacity mark

■Power/Heat

W	cal/s	kcal/h	Btu/h	HP	kg·m/s	lb·m/s
1	0.23885	0.85985	3.4121	0.001341	0.10197	0.73756
4.1868	1	3.6	14.286	0.0056146	0.42693	3.088
1.163	0.27778	1	3.9683	0.0015596	0.11859	0.85778
0.29307	0.06999	0.252	1	3.9302×10^{-4}	0.029885	0.21616
745.7	178.11	641.19	2,544.4	1	76.04	550
9.8067	2.3423	8.4322	33.462	0.013151	1	7.233
1.3558	0.32383	1.1658	4.6262	0.0018182	0.13826	1



14-4 Q & A for Non-trouble

Classification	Class	Description
Cooling	Q	The cooling is weak.
	A	When it is hot outside, its cooling capacity decreases due to the increase of the ambient temperature. When the dust filter gets blocked or warm outside air gets in, the cooling capacity will decrease. So, make sure to clean the dust filter frequently, prevent heat loss by closing the doors and insulate the cooling area by using curtains, blinds, shades or window tinting.
	Q	The cooling is good generally. But, it gets weak when it is considerably hot.
	A	It occurs when the outdoor unit is exposed to direct sun light and heat-up air is not ventilated well. So, set up a sunblind over the outdoor unit and keep stuff away from the unit to increase the ventilation. When the cooling capacity decreases during a heat wave, clean the heat exchanger of the outdoor unit or spray some cold water to the heat exchanger to increase the cooling capability.
	Q	The cooling is weak. Does it need refrigerant charging?
	A	It is not correct charging refrigerant regularly. Except that you have moved in several times or the connection pipes are broken, the refrigerant does not run low. So, when refrigerant is additionally charged, it could be costly and cause a product's failure. When the refrigerant leaks, all of it will escape in a short time resulting in cooling failure and no water coming out of the drain hose. So, if water comes out from the drain hose, it indicates the normal operation of the product and it does not need refrigerant charging.
	Q	It fails to do cooling.
	A	When the air conditioner is set to Ventilation or the desired temperature is set higher than the current temperature, it fails to do cooling. In this case, select Cooling or set the desired temperature lower.
Leakage	Q	It floods the floor.
	A	Place the drain hose properly. When it is not placed properly, the drain water would flow back flooding the floor. So, straighten out the drain hose for the water to be drained well.
	Q	Water drips at the drain connection (service valve) of the outdoor unit.
	A	When a glass bottle is taken out of the refrigerator, moisture gets condensed on its surface due to the temperature differences. The same principle applies to the air conditioner. When cold refrigerant goes through the copper tube, moisture gets condensed on the surface of the tube and the connection areas. To prevent the water condensation, the pipes are insulated. But, the connection areas of the outdoor unit are not insulated for the purpose of maintenance or repair, and water gets condensed due to the temperature differences and drips down. Generally, it evaporates right away. But, when it drips much during muggy days, put a water pan on the floor.
	Q	It leaks even though a drain pump is used.
A	It occurs when the drain pump is plugged out or it is out of order. Check the power of the drain pump and the position of the drain hose, and when the pump is faulty, contact the drain pump manufacturer. Samsung Electronics do not manufacture drain pumps. So, we are not able to correct the drain pump problems.	
Smells	Q	Whenever the air conditioner is turned on, it irritates my eyes and gives me a headache.
	A	There are no components in the air conditioner irritating the eyes and sending out chemical smells. But, when the air conditioner is turned on, other smell sources are sucked into the air conditioner and get out of it. So, find and root out the smell sources. Generally, it occurs at a interior renovated place, a pharmacy, a gasoline handling place, a tire shop, a second-hand book shop or an electronic component handling place; when its chemical or musty smells are sucked in and sent out, it can be misled that the air conditioner generates them. So, find and root out the problem or refresh the room frequently.

Classification	Class	Description
Smells	Q	Whenever the air conditioner is turned on, it stinks.
	A	There are no components in the air conditioner sending out chemical smells. But, when the air conditioner is turned on, other smell sources are sucked into the air conditioner and get out of it. So, find and root out the smell sources. Generally, when the drain hose is taken out to the washing room or there are sources of smells such as a diaper bin, a shoe shelf or a socks bin, bad smells generate. Also, it occurs where glass cleaners or air fresheners are used; when they are sucked in interacting with dusts and moistures inside, bad smells generate. These kinds of organic materials noxious to human bodies. So, we recommend against the use of them.
	Q	Whenever the air conditioner is turned on, it smells sour.
	A	When the room is papered recently, its paste smells would be sucked inside. Also, when the air conditioner is installed in the study room of young boys loving sweat-generating activities such as the basketball, excessive sweats evaporate and get sucked into the air conditioner resulting in bad smells. So, find and root out the problem or refresh the room frequently.
	Q	Whenever the air conditioner is turned on, it smells musty.
	A	It is due to the improper keeping of the product after its use. When keeping the product, dry up the inside with the operation of Ventilation to prevent must. When the product is kept without drying up the inside with Ventilation, mold would grow inside resulting in must. So, open the windows and switch on the Ventilation function to get rid of the saturated smell inside.
	Q	Whenever the air conditioner is turned on, it sends out bad smells such as stale smells.
	A	It occurs generally when there are pet animals in the house. Their smells stay at the same place. But, when the air conditioner is turned on, the air gets circulated resulting in the circulation of the smells. So, find and root out the problem or refresh the room frequently.
	Q	It sends out bad smells.
A	When the air filter is filthy, it could send out bad smells. So, clean the filter and ventilate the room with the windows open while operating the Ventilation function.	
Operation	Q	It won't start.
	A	There is a power failure or it is plugged out. Also, check if the power distribution panel is switched off.
	Q	It goes off during operation.
	A	When the hot air does not escape properly, it goes off during operation. It occurs when it does not ventilate properly because the outdoor unit is covered, the back of the outdoor unit is blocked by a cardboard or a plywood panel, and the front of the outdoor unit is blocked by the closed window or other obstacles. Clear the above obstacles from the outdoor unit.
	Q	It generally works properly. But, when it's considerably hot, it goes off during operation.
	A	It occurs when the outdoor unit is exposed to direct sunlight and the hot air does not escape properly. Set up a sun blind over the outdoor unit and clear the neighboring obstacles from the outdoor unit to provide good ventilation. When it goes off frequently during a heat wave, it would prevent the turn-off and increase the cooling capacity cleaning the outdoor unit or spraying some water to the heat exchanger.
Q	The remote controller won't operate.	
A	When the batteries run out or the transmitter or receiver of the remote controller is blocked by obstacles, change the batteries or keep the obstacles away from the controlling area. Also, the remote controller may not work under intensive light from a 3-wave length lamp or a neon sign due to the EMI. In this case, take the remote controller closer to the receiver.	

Classification	Class	Description
Installation	Q	Who installs the air conditioner? (Relocation/Re-installation)
	A	When relocating or re-installing the air conditioner, make sure to contact Samsung Electronics Service Center or Authorized Service Agent and have them to do the job. (If not, it could cause personal injury or product damage.) The cost for the relocation/re-installation of the air conditioner is subject to the customer's expense. There is a cost table. But, our service engineer needs to visit to total up the cost correctly. When you move in, make sure to contact Samsung Electronics Service Center or Authorized Service Agent in advance to streamline the process.
	Q	Is it possible to install the outdoor unit outside?
	A	It is possible to install it at a designated place in the apartment or on the rooftop nearby. But, it's illegal hanging an angle iron case with the outdoor unit in it outside the apartment. Also, it is illegal obstructing passers-by with the outdoor unit installed outside.
	Q	What can be done to install the outdoor unit facing the road because it is a commercial building?
	A	The following is an excerpt from Building Code going into effect from JUNE 1st 2005. "The exhaust pipe of a cooling or ventilation facility installed in a building adjacent to the streets of commercial or residential areas shall be installed higher than 2 m to prevent the exhaust air from blowing directly to passers-by and the current facilities shall be corrected by MAY 31st 2005." So, please install it higher than 2 m or not to blow the hot exhausting air directly to passers-by.
	Q	What about installing a windscreen during installation not to blow hot air directly to passers-by?
A	When the hot air from the front of the outdoor unit is blocked, the product's performance will be affected and it will fail to operate properly. So, keep it at least 300mm away from its surrounding walls and give it good ventilation.	

14-5 Cleaning/Filter Change

14-5-1 Cleaning your Air Conditioner

To get the best possible use out of your air conditioner, you must clean it regularly to remove the dust that accumulates on the air filter.



• Before cleaning your air conditioner, ensure that you have switched off the breaker used for the unit.

1. Open the front panel by pulling tabs on the lower right and left sides of the indoor unit.

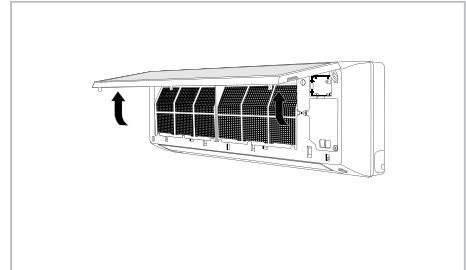

2. Detach the front panel by pulling it forwards.
3. Hold the edge of the air filter under the front panel and pull to release.
4. Remove all dust on the air filter with a vacuum cleaner or brush.
5. WHEN YOU FINISH, INSERT THE TOP OF THE FILTER INTO THE SLOT AND FIX IT TO 5 tabs or 3 tabs of the panel.

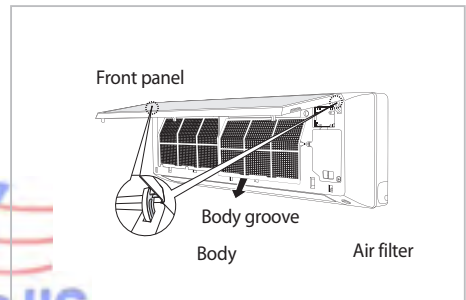

6. CLEAN THE FRONT PANEL WITH A DAMP CLOTH AND MILD DETERGENT (do NOT use benzene, solvents or other chemicals).
7. Reassemble the air filter and the front panel.

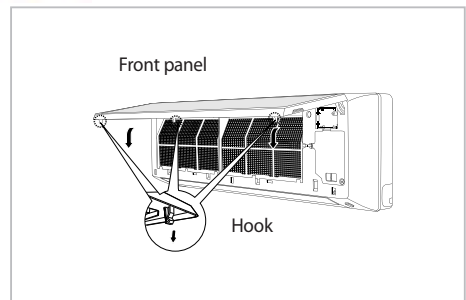

Note : • If you have not used the air conditioner for a long period of time, set the fan going for three to four hours to dry the inside of the air conditioner thoroughly.

14-5-2 Cleaning Anti-allergy Filter

Anti-allergy filter protects you from allergy-causing particles, even if you raise pets at home.

- 1 Open the upper front panel by pulling the lower right and left tabs of the panel.
- 2 Detach the anti-allergy filter(sky blue) by pulling it forwards.
- 3 Wash the filter with clean water.
 - ◆ Make sure not to rub the filter when washing.
- 4 Dry it in the shade, and then insert it in its place.
 - ◆ Avoid direct sunlight when dry the anti-allergy filter. If not, it may cause variation.
- 5 Close the front panel.

Note

- ◆ **You should clean the filters every 3 months even if the cleaning period might be different depending on how long and where you are using.**
- ◆ **The filter function is not affected even if deodorizing filter and anti-allergy filter are inverted.**

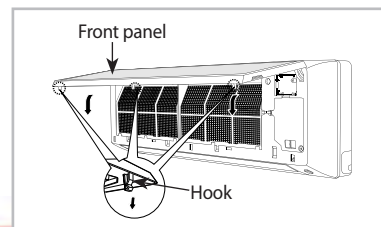
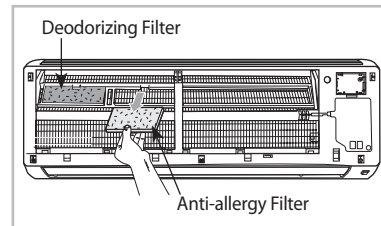
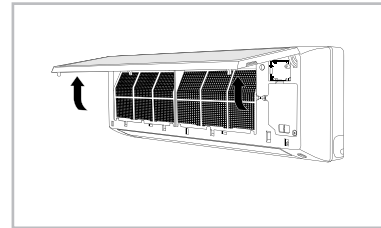

14-5-3 Replacing Deodorizing Filter



Activated carbon is incorporated in the Deodorizing filter, efficiently absorbing cigarette smoke, pet odors and other unpleasant smells.

- 1 Open the upper front panel by pulling the lower right and left tabs of the panel.
- 2 Detach the deodorizing filter(black) by pulling it forwards.
- 3 Replace the deodorizing filter with a new one into the slot.
 - ◆ Use the deodorizing filter you purchased after removing the vinyl wrap.
- 4 Close the front panel.

Note

- ◆ **You should clean the filters every year even if the replacing period might be different depending on how long and where you are using.**
- ◆ **You can purchase deodorizing filter at the customer care center.**
- ◆ **The filter function is not affected even if deodorizing filter and anti-allergy filter are inverted.**

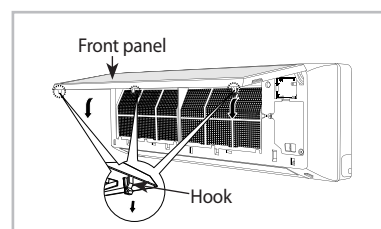
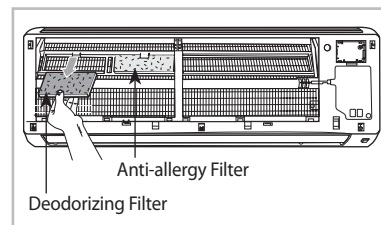
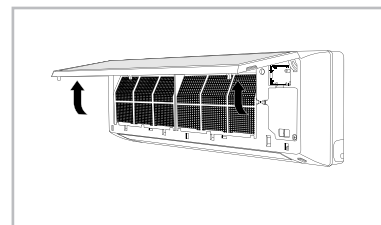

14-6 Installation

14-6-1 Before Installation

Keep the air conditioner outlet and inlet free from its surroundings.
In case of installation, keep the symmetry and fix it to prevent vibration.
The pipe length shall meet the standard as far as possible.

14-6-2 Installation Procedure

■ Location

Install the product in an area to guarantee the best cooling effect, convenience of piping and electric work, and inexistence of vibration or wind.

■ Wall Drilling

Drill the wall downward in a diameter of 60 to 65mm.

■ Fixing Indoor Unit & Outdoor Unit

Fix the air conditioner indoor unit securely to the wall. Secure the outdoor unit in a suitable position.

■ Pipe Spooling & Connecting

You shall cut the pipe with a pipe cutter and grind all the burrs of the cut surface.
Pipe expansion may continue until the pipe surface becomes uneven or torn apart.
Be sure to use a torque wrench to tighten pipes or flare nuts.

<Torque & Depth>

Outer Diameter(D)	Torque(kgf-cm)	Depth(A)
6.35mm(1/4")	140~170	1.3mm
9.52mm(3/8")	250~280	1.8mm
12.70mm(1/2")	380~420	2.0mm
15.88mm(5/8")	440~480	2.2mm
19.05mm(3/4")	990~1,210	2.2mm

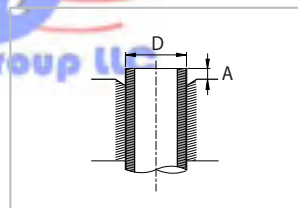

■ Leak Test

Put an inert gas like nitrogen in the outdoor unit pipe and put soap bubbles or other test liquids on the pipe surface for the leak test.

■ Drain Hose Connecting

Install the drain hose downward to drain water naturally. Be sure to pour water into the hose to check if it drains well.

■ Electric & Earth Work

Electric and earth work shall meet the "Electric Facility Technology Standard" and the "Internal Wire Regulation" of the Electric Business Laws.

■ Inspection & Trial Run

Upon completion of the tests, you shall make a trial run while you explain the main functions of the air conditioner to finish the installation.

14-7 Installation Diagram of Indoor Unit and Outdoor Unit

14-7-1 Air-Purge Procedure

- 1) Connect each assembly pipe to the appropriate valve on the outdoor unit and tighten the flare nut.



- 2) Connect the charging hose of low pressure side of manifold gauge to the packed valve having a service port as shown at the figure.



- 3) Open the valve of the low pressure side of manifold gauge counter-clockwise.



- 4) Purge the air from the system using vacuum pump for about 30 minutes.

- Make sure that pressure gauge show $-0.1\text{MPa}(-76\text{cmHg})$ after about 30 minutes.
- This procedure is very important in order to avoid gas leak.
- Turn off the vacuum pump.
- Close the valve of the low pressure side of manifold gauge clockwise.
- Remove the hose of the low pressure side of manifold gauge.



- 5) Set valve cork of both liquid side and gas side of packed valve to the open position.



- 6) Mount the valve stem nuts and the service port cap to the valve, and tighten them at the torque of $183\text{kgf}\cdot\text{cm}$ with a torque wrench.



- 7) Check for gas leakage.

- At this time, especially check for gas leakage from the 3 way valve's stem nuts, and from the service port cap.

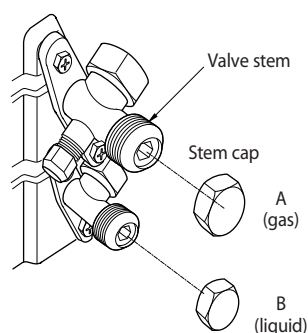
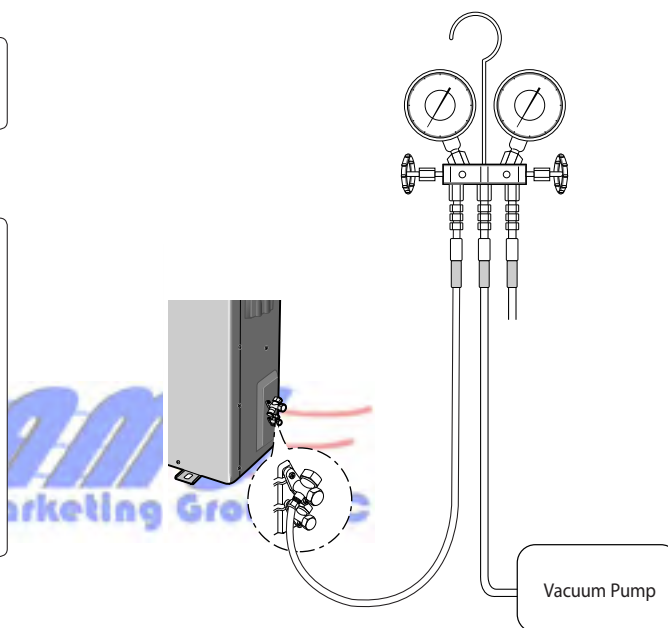
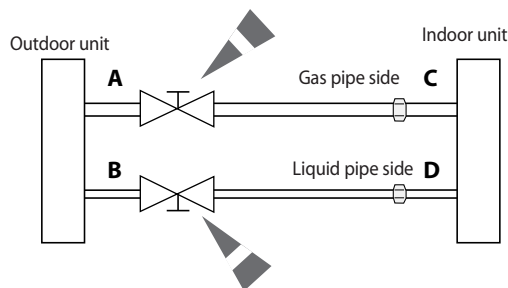

14-7-2 "Pump down" Procedure

Pump down will be carried out when an evaporator is replaced or when the unit is relocated in another area.

1) Remove the caps from the 3 way valve and the 3-Way valve.



2) Turn the 3-Way valve clockwise to close and connect a pressure gauge (low pressure side) to the service valve, and open the 3 way valve again.



3) Set the unit to cool operation mode.
(Check if the compressor is operating.)



4) Turn the 3-Way valve clockwise to close.



5) When the pressure gauge indicates "0" turn the 3-Way valve clockwise to close.



6) Stop operation of the air conditioner.



7) Close the cap of each valve.

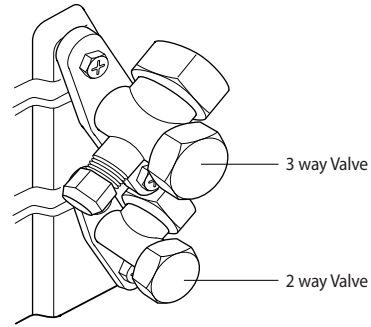

Remarks

Relocation of the air conditioner

- Refer to this procedure when the unit is relocated.
- Carry out the pump down procedure (refer to the details of 'pump down').
- Remove the power cord.
- Disconnect the assembly cable from the indoor and outdoor units.
- Remove the flare nut connecting the indoor unit and the pipe.
- At this time, cover the pipe of the indoor unit and the other pipe using a cap or vinyl plug to avoid foreign material entering.
- Disconnect the pipe connected to the outdoor unit.
- At this time, cover the valve of the outdoor unit and the other pipe using a cap or vinyl plug to avoid foreign material entering.
- Make sure you do not bend the connection pipes in the middle and store together with the cables.
- Move the indoor and outdoor units to a new location.
- Remove the mounting plate for the indoor unit and move it to a new location.



GSPN(Global Service Partner Network)

Area	Web Site
North America	http://service.samsungportal.com
Latin America	http://latin.samsungportal.com
CIS	http://cis.samsungportal.com
Europe	http://europe.samsungportal.com
China	http://china.samsungportal.com
Asia	http://asia.samsungportal.com
Mideast & Africa	http://mea.samsungportal.com

This Service Manual is a property of Samsung Electronics Co., Ltd.
 Any unauthorized use of Manual can be punished under applicable
 International and/or domestic law.

© Samsung Electronics Co., Ltd. Dec. 2007.
 Printed in China.
 Code No. DB98-29098A(1)