



INSTALLATION MANUAL

**EH035CAV
EH052CAV
EH070CAV**

ENGLISH

ESPAÑOL

FRANÇAIS



System Air Conditioner (Cooling and Heating)

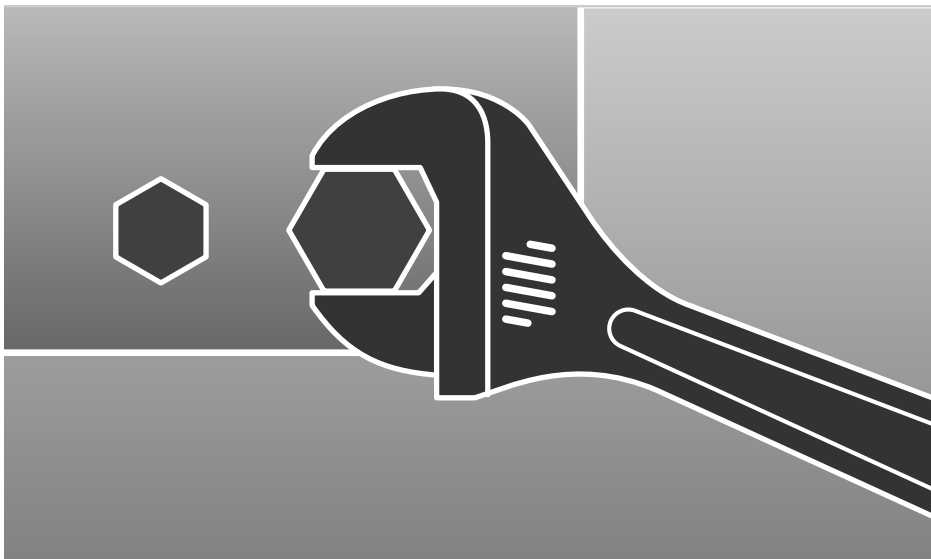

Safety Precautions

The following safety precautions must be taken when using your air conditioner.



WARNING

- Risk of electric shock can cause injury or death.
- Disconnect all remote electric power supplies before servicing, installing or cleaning.
- This must be done by the manufacturer or its service agent or a similar qualified person in order to avoid a hazard.

INSTALLING THE UNIT

- ◆ The unit should not be installed by the user. Ask the dealer or authorized company to install the units except room air conditioners for the U.S.A and Canada area.
- ◆ If the unit is installed improperly, water leakage, electric shock or fire may result.
- ◆ Mount with the lowest moving parts at least 2.5 m above the floor or grade level. (If applicable)
- ◆ The manufacturer does not assume responsibility for accidents or injury caused by an incorrectly installed air conditioner. If you are unsure about installation, contact an installation specialist.
- ◆ When installing the built-in type air conditioner, keep all electrical cables such as the power cable and the connection cord in pipe, ducts, cable channels e.t.c to protect them against liquids, outside impacts and so on.
- ◆ This appliance is not accessible to the general public. This appliance should be installed according to the provided installation instruction.

POWER SUPPLY LINE, FUSE OR CIRCUIT BREAKER

- ◆ If the power cord of this air conditioner is damaged, it must be replaced by the manufacturer, its service agent or similarly qualified persons in order to avoid a hazard.
- ◆ The unit must be plugged into an independent circuit if applicable or connect the power cable to the auxiliary circuit breaker. An all pole disconnection from the power supply must be incorporated in the fixed wiring with a contact opening of >3mm.
- ◆ Do not use an extension cord with this product.
- ◆ If the unit is equipped with a power supply cord and a plug, the plug must be accessible after installation.
- ◆ The air conditioner must be installed in accordance with national wiring regulations and safety regulations wherever applicable.

Contents

■ Deciding on Where to Install the Air Conditioner.....	4
■ Deciding on Where to Install the Indoor Unit.....	6
■ Indoor Unit Installation	8
■ Purging the Unit	9
■ Connecting the Refrigerant Pipe	10
■ Cutting/Flaring the Pipes	11
■ Performing Leak Test & Insulation	12
■ Drain Pipe and Drain Hose Installation.....	13
■ Connecting the Connection Cord.....	15
■ Adjusting Air Flow	17
■ Setting Up the Mode Option	18
■ Assigning Address to Indoor Unit	21
■ Additional Functions	22
■ Filter Replacement (Optional)	24
■ Drain pump Installation (Optional)	26
■ Troubleshooting	28
■ Parts list	32



Deciding on Where to Install the Air Conditioner

When deciding on the location of the air conditioner with the owner, the following restrictions must be taken into account.

General







Do NOT install the air conditioner in a location where it will come into contact with the following elements:

- ◆ Combustible gases
- ◆ Saline air
- ◆ Machine oil
- ◆ Sulphide gas
- ◆ Special environmental conditions



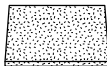
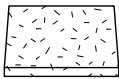
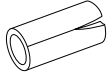
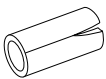
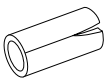



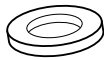

If you must install the unit in such conditions, first consult your dealer.

Accessories

- ◆ The following accessories are supplied with the indoor unit.
The type and quantity may differ depending on the specifications.

User's manual 	Installation Manual 	Insulation Cover Pipe in 	Insulation Cover Pipe out 
Insulation Drain 	Insulation Cover Drain 	Insulation Pipe in 	Insulation Pipe out 
Cable-Tie 	Flexible hose 	Flexible hose clamp 	Rubber 

Wired Remote Controller Accessories

Wired remote controller 	Cable-tie 	Cable clamp 	M4x16 tapped screw 
Indoor unit power drawing cable 	Communication cable of the wired remote controller 	Wire joint 	User's manual 
Installation Manual 			

Indoor Unit

- ◆ There must be no obstacles near the air inlet and outlet.
- ◆ Install the indoor unit on a ceiling that can support its weight.
- ◆ Maintain sufficient clearance around the indoor unit.
- ◆ Make sure that the water dripping from the drain hose runs away correctly and safely.
- ◆ The indoor unit must be installed in this way, that they are out of public access. (Not touchable by the users)
- ◆ After connecting a chamber, insulate the connection part between the indoor unit and the chamber with t10 or thicker insulation. Otherwise, there can be air leak or dew from the connection part.

Space Requirements for Indoor Unit

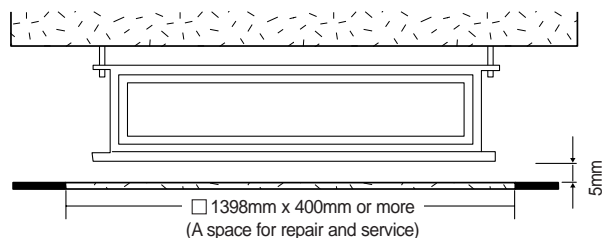
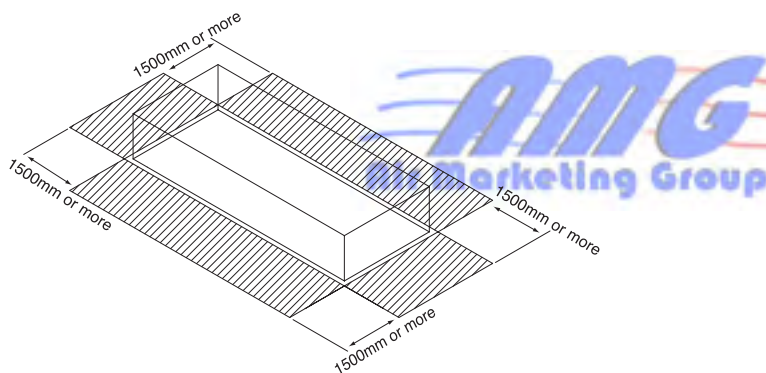

You must have 5mm or more space between the ceiling and the bottom of indoor unit. Otherwise, the noise from the vibration of indoor unit may bother the user. When the ceiling is under construction, the hole for check-up must be made to take service, clean and repair the unit.

Deciding on Where to Install the Indoor Unit

Drawing of the indoor unit

035

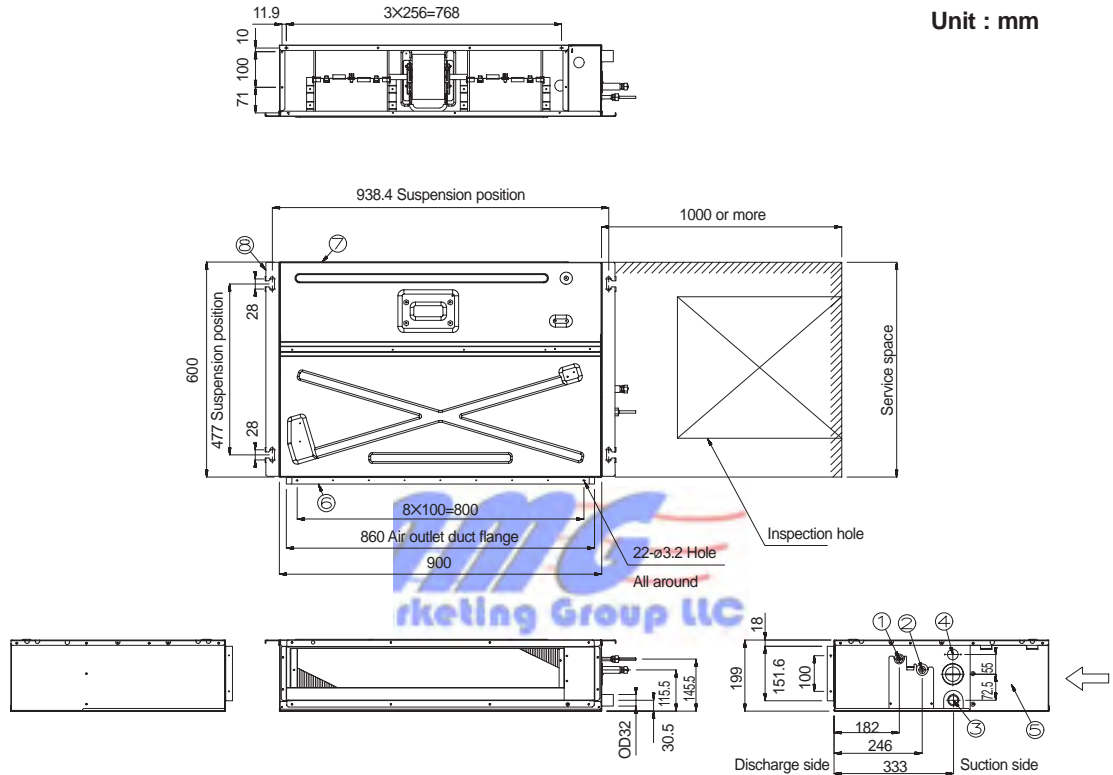

No.	Name	Remark
1	Liquid pipe connection	ø6.35 (1/4")
2	Gas pipe connection	ø9.52 (3/8")
3	Hose connection	
4	Hose connection	
5	Power supply/Communicaion connection	
6	Power supply connection	
7	Air discharge grille flange	
8	Air inlet grille flange	M8-M10

052/070

Unit : mm

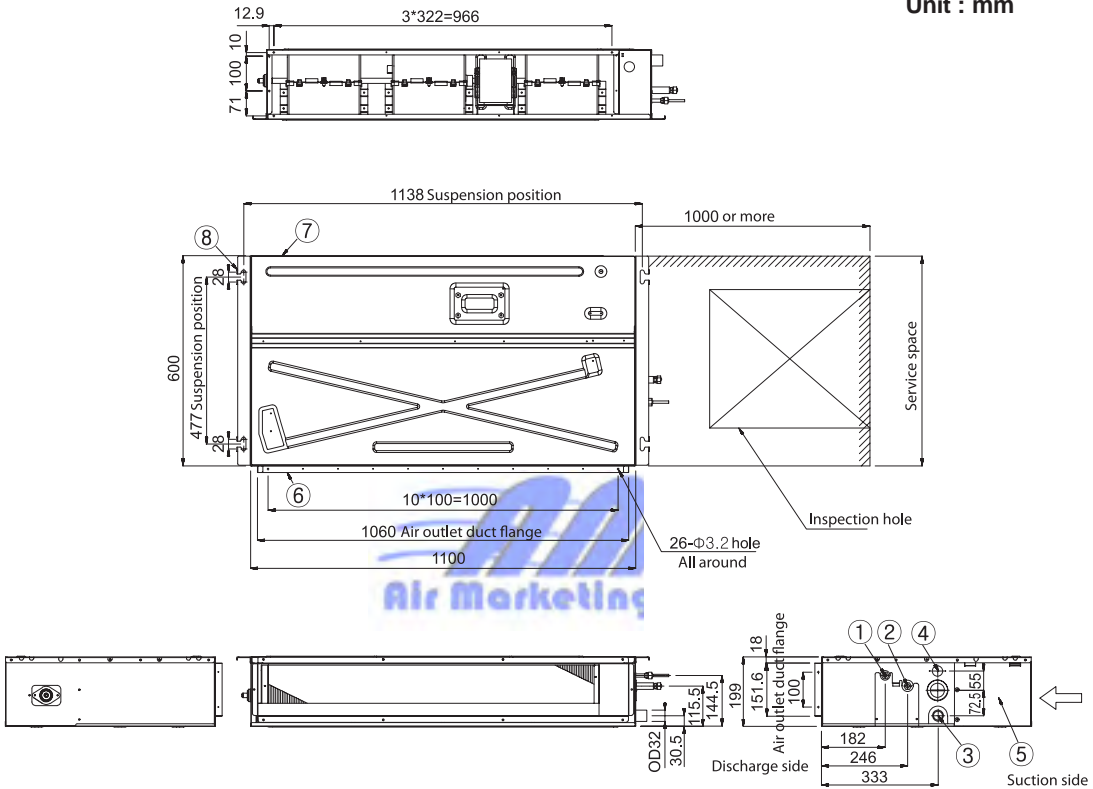

No.	Name	Remark
1	Liquid pipe connection	ø6.35
2	Gas pipe connection	ø12.70(**052**)/ ø15.88(**070**)
3	Drain pipe connection	OD32 ID26
4	Drain pipe connection	Using drain pump (Optional)
5	Power supply connection	
6	Air inlet grille flange	
7	Air filter	
8	Hook	For M8-M10

Indoor Unit Installation

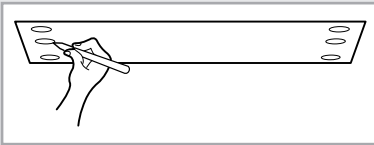

- 1 Mark the place to insert the suspension bolt where you want to install the indoor unit.

Note Refer to pages 6-7 for the dimension.

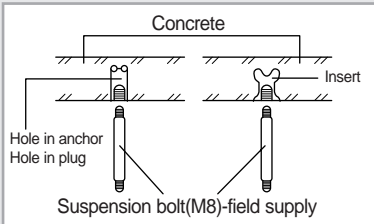

- 2 Insert bolt anchors. Use existing ceiling supports or construct a suitable support as shown in figure.

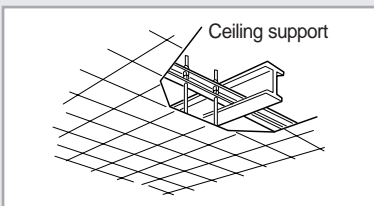

- 3 Install the suspension bolts depending on the ceiling type.

CAUTION Ensure that the ceiling is strong enough to support the weight of the indoor unit. Before hanging the unit, test the strength of each attached suspension bolt.

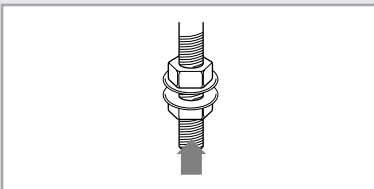

- 4 Screw eight nuts to the suspension bolts making space for hanging the indoor unit. Make sure you have space for hanging the indoor unit.

CAUTION You must install the suspension bolts more than four when installing the indoor unit.

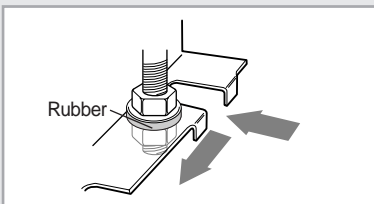

- 5 Hang the indoor unit to the suspension bolts between two nuts.

Note Tubing must be laid and connected inside the ceiling when suspending the unit. If the ceiling is already constructed, lay the piping into position for connection to the unit before placing the unit inside the ceiling.

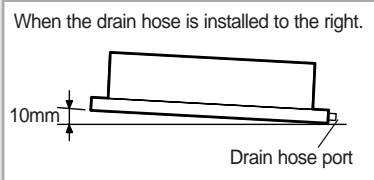

- 6 Screw the nuts to suspend the unit.

- 7 Adjust level of the unit by using measurement plate for all 4 sides.

Note For proper drainage of condensate, give a 3mm slant to the left or right side of the unit which will be connected with the drain hose, as shown in the figure. Make a tilt when you wish to install the drain pump, too.

Purging the Unit

On delivery, the indoor unit is loaded with refrigerant gas. All this gas must therefore be purged before connecting the assembly piping.

To purge the inert gas, proceed as follows.

Unscrew the pinch pipe at the end of each refrigerant pipe.

Result: All inert gas escapes from the indoor unit.

Note To prevent dirt or foreign objects from getting into the pipes during installation, do NOT remove the pinch pipe completely until you are ready to connect the piping.

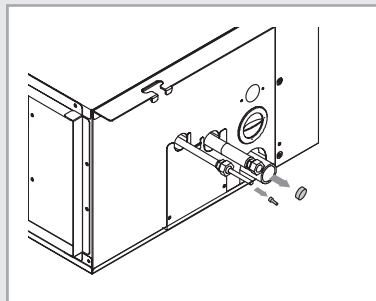

Connecting the Refrigerant Pipe

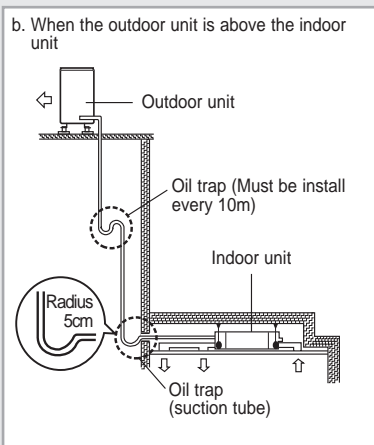
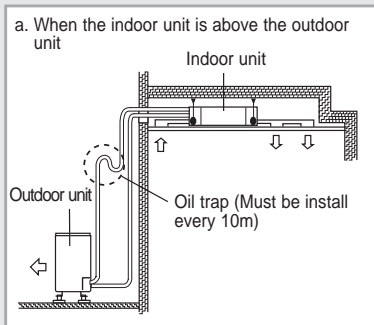
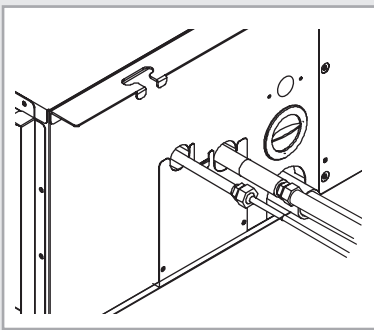
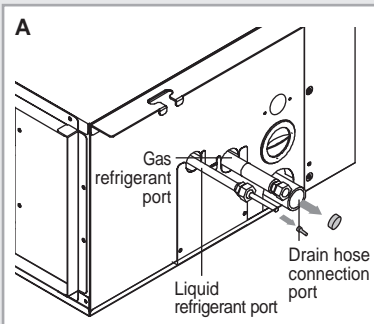

There are two refrigerant pipes of different diameters:

- ◆ A smaller one for the liquid refrigerant
- ◆ A larger one for the gas refrigerant
- ◆ The inside of copper tube must be clean & has no dust.

The connection procedure for the refrigerant pipes varies according to the exit position of the pipes from the indoor unit, as seen when facing the indoor in the "A" side.

- ◆ Liquid refrigerant port
- ◆ Gas refrigerant port
- ◆ Drain hose port

- 1 Remove the pinch pipe on the pipes and connect the assembly pipes to each pipe, tightening the nuts, first manually and then with a torque wrench, a spanner applying the following torque.

Outer Diameter	Torque (kgf·cm)
6.35 mm (1/4")	140~170
9.52 mm (3/8")	250~280
12.70 mm (1/2")	380~420
15.88 mm (5/8")	440~480
19.05 mm (3/4")	990~1210
22.23 mm (7/8")	990~1210

Note If the pipes must be shortened refer to page 11.

- 2 Must use insulator which is thick enough to cover the refrigerant tube to protect the condensate water on the outside of pipe falling onto the floor and the efficiency of the unit will be better.

- 3 Cut off any excess foam insulation.

- 4 Be sure that there must be no crack or wave on the bended area.

- 5 It would be necessary to double the insulation thickness(10mm or more) to prevent condensation even on the insulator when if the installed area is warm and humid.

Cutting/Flaring the Pipes

- 1 Make sure that you have the required tools available (pipe cutter, reamer, flaring tool and pipe holder).
- 2 If you wish to shorten the pipes, cut it with a pipe cutter, taking care to ensure that the cut edge remains at a 90° angle with the side of the pipe. Refer to the illustrations below for examples of edges cut correctly and incorrectly.

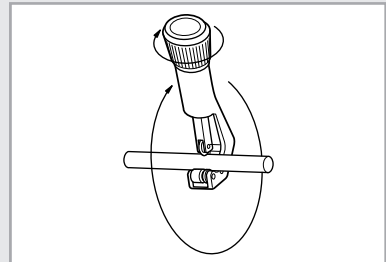
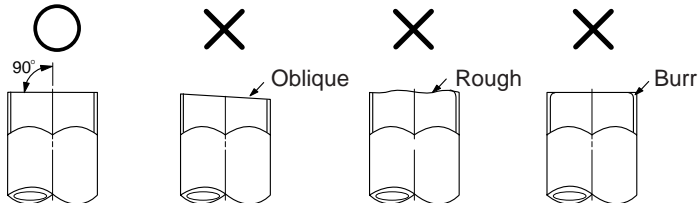

- 3 To prevent any gas from leaking out, remove all burrs at the cut edge of the pipe, using a reamer.

- 4 Slide a flare nut on to the pipe and modify the flare.

Outer Diameter (D)	Depth (A)
6.35 mm (1/4")	1.3mm
9.52 mm (3/8")	1.8mm
12.70 mm (1/2")	2.0mm
15.88 mm (5/8")	2.2mm
19.05 mm (3/4")	2.2mm
22.23 mm (7/8")	2.2mm

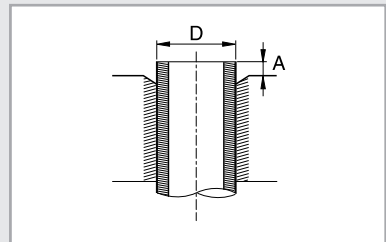

- 5 Check that the flaring is correct, referring to the illustrations below for examples of incorrect flaring.

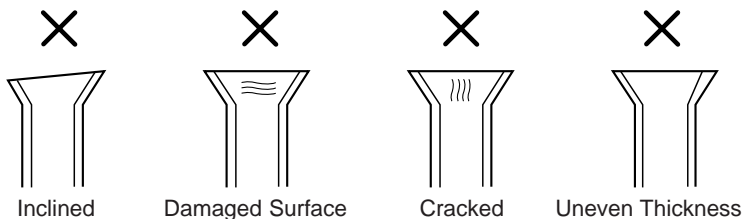

- 6 Align the pipes and tighten the flare nuts first manually and then with a torque wrench, applying the following torque.

Outer Diameter	Torque (kgf•cm)
6.35 mm (1/4")	140~170
9.52 mm (3/8")	250~280
12.70 mm (1/2")	380~420
15.88 mm (5/8")	440~480
19.05 mm (3/4")	990~1210
22.23 mm (7/8")	990~1210

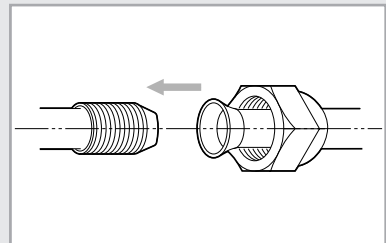

CAUTION

◆ In case of welding the pipe, you must weld with nitrogen gas blowing.

Performing Leak Test & Insulation

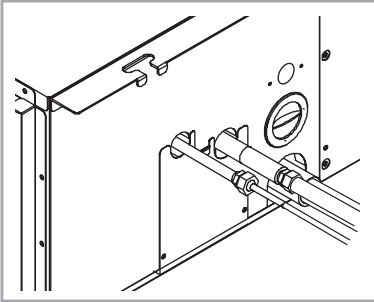

Leak Test

To check for gas leaks on the indoor unit, check the connection part of each refrigerant pipe by using a leak detector.

Insulation

Once you have checked that there are no leaks in the system, you can insulate the piping and hose.

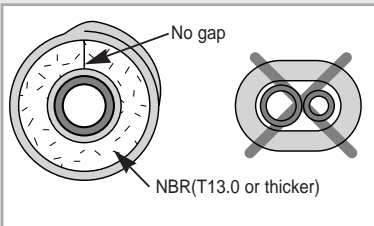

- 1 To avoid condensation problems, place **T13.0 or thicker Acrylonitrile Butadiene Rubber** separately around each refrigerant pipe.

Note Always make the seam of pipes face upwards.

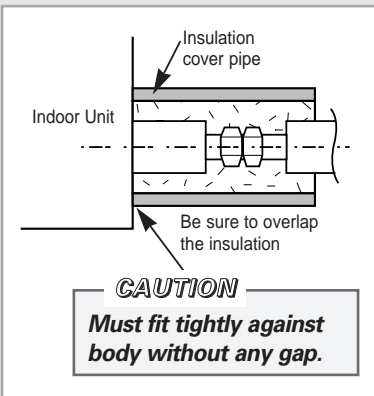

- 2 Wind insulating tape around the pipes.

- 3 Finish wrapping insulating tape around the rest of the pipes leading to the outdoor unit.
-

Drain Pipe and Drain Hose Installation

Care must be taken when installing the drain hose for the indoor unit to ensure that any condensate water is correctly drained outside. The drain hose can be installed to the right or left side of the base pan.

1 Install the drain hose as short as possible.

- Note**
- ◆ Give a 3mm slant to the drain hose for proper drainage of condensate.
 - ◆ Secure the drain hose with the cable-tie not to be separated from the unit.
 - ◆ The drain pump connection port is used when using a drain pump.

2 Insulate the drain hose and then fix it as a picture.

- Note**
- ◆ Assemble flexible hose with clamps between indoor unit and drain pipe.
 - ◆ Flexible hose clamps should be assembled tightly to prevent being loosen. If it is loosen, it may cause water drops.



1 Insert the flexible hose to the drain hose port.

- Note** Fix the flexible hose to the indoor unit with the supplied cable clamp securely.
(Use the screwdriver to fix the flexible hose securely.)

2 Install the drain hose so that its length can be as short as possible. Internal diameter of the drain hose should be the same or slightly bigger than the external diameter of the drain hose port.

◆ **Inner diameter of the drain hose**

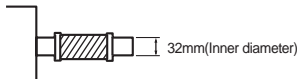

- Note**
- ◆ Give a slightly slant to the drain hose for proper drainage of condensate.
 - ◆ Fix the flexible hose to the PVC with the supplied cable tie securely.

3 Wrap the drain hose with the insulation drain as shown in figure and secure it.

035

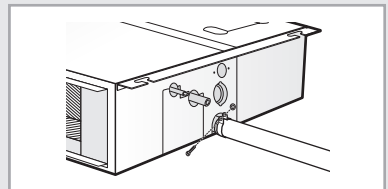
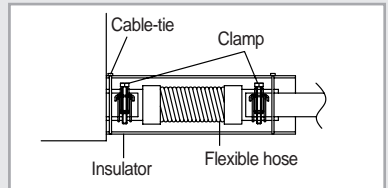
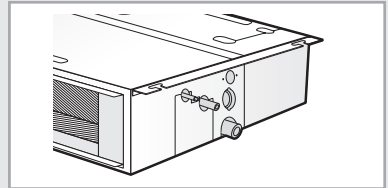

052/070

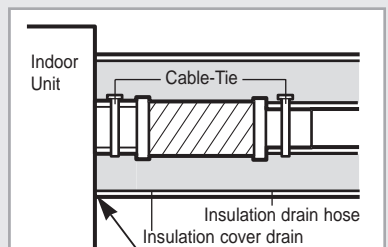
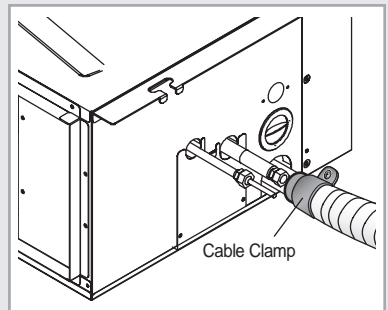

CAUTION
Must fit tightly against body without any gap.

Drain pipe and Drain Hose Installation (Continued)

CAUTION

When not installing the drain pump

Do not give the hose upward gradient after the connection port.
This will cause water to flow backwards when the unit is stopped, resulting in water leaks.

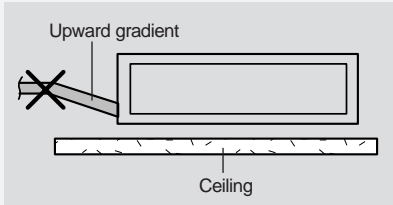

Do not apply force to the piping on the unit side when connecting the drain hose. The hose should not be allowed to hang loose from its connection to the unit. Fasten the hose to a wall, frame or other support as close to the unit as possible.

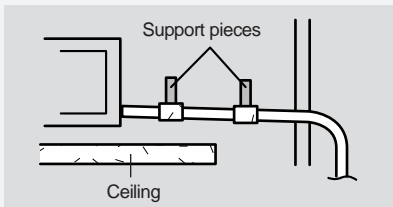

When installing the drain pump(**035**)

When installing a flexible hose, the difference of pivot of a drain hose port and a drain hose must be within 20mm. If the difference of each pivot is more than 20mm, or a flexible hose is bent steeply, a flexible hose may leak.

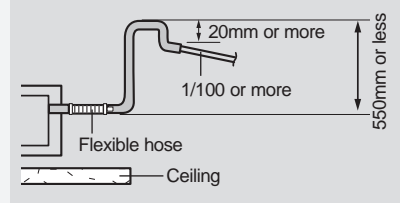

When installing the drain pump(**052/070**)

If it is necessary to increase the height of the drain hose somewhat, the portion directly after 75cm. If it is raised higher than 75cm, there can be water leaks.

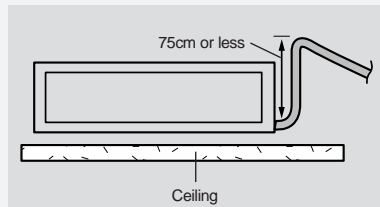

035

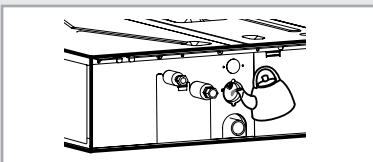
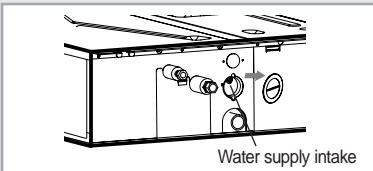

052/070

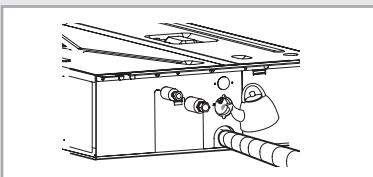
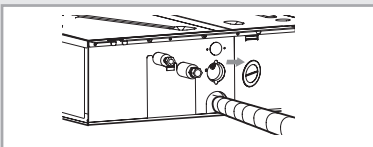

Testing the drainage

Prepare a little water about 5 liter.

- 1 Open the cover of water supply intake by turning and pulling the cover.
(Only for **035**)

- 2 Pour water into the the indoor unit as shown in figure.
Note If you do not pour water inside the water supply intake, water may spill from the indoor unit.

- 3 Confirm that the water flows out through the drain hose.

- 4 Reassemble the cover of water supply intake.
(Only for **035**)

Connecting the Connection Cord

The indoor unit is powered from the outdoor unit via the connection cord.

- 1 Remove the screw on the electrical component box and remove the cover plate.
- 2 Route the connection cord through the side of the indoor unit and connect the cable to terminals; refer to the figure below.

Note When connecting the cables, you must pass them through the cable clamp to fix them securely.

- 3 Route the other end of the cable to the outdoor unit through the ceiling & the hole on the wall.
- 4 Reassemble the electrical component box cover, carefully tightening the screw.

Between Indoor and Outdoor Connection Cord Specifications

Power Supply (Single Phase)			Earth Cable	Communication Cable	Home server
Power Supply	Max/Min(V)	Connection Wire			
208-230V~ /60Hz	±10%	0.75mm ² (2 wires)	Ø 1.6mm (1 wire)	0.75mm ² (2 wires)	0.75~ 1.25mm ² (2 wires)

* For connection cord, use the grade H07RN-F or H05RN-F materials.

CAUTION

Keep the power cable and the connection cord in a steel pipe to protect them against liquids, outside impacts and so on.

Connecting the Connection Cord (Continued)

Wiring and Communication Cable Connection

Connect the power cable, which is connected with the outdoor unit and supplied by another source, making sure that the power cable terminal should not be changed.
The F3 and F4 communication cable may be cross-connected, however, it is recommended that they are connected to the corresponding F3 and F4 terminal.

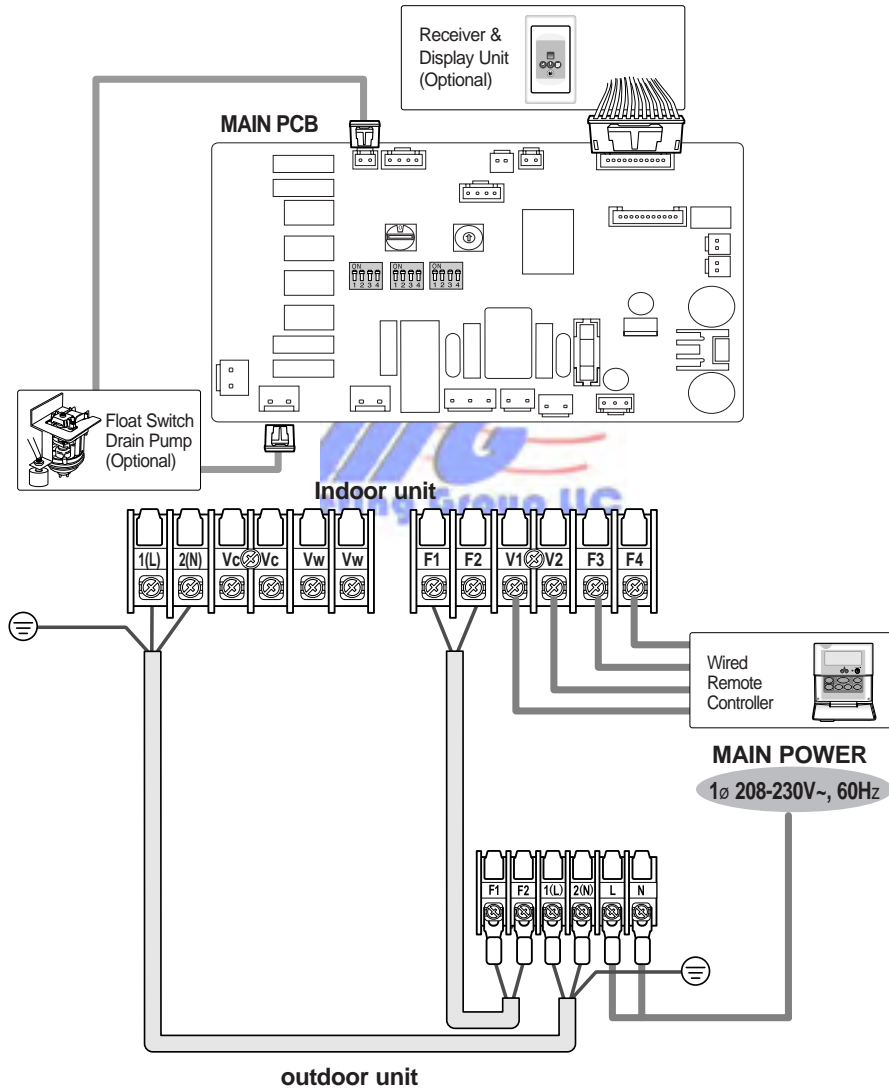

Adjusting Air Flow

E. S. P(External Static Pressure) Setting for Phase Control Motor

With its phase control motor, you can adjust the indoor unit fan speed depending on the installation condition. If the external static pressure is high so that the duct becomes longer or if the external static pressure is low so that the duct becomes shorter, adjust the fan speed by referring the following table. Refer to the page 18 to set the option code.

035

Static Pressure(mmAq)		0	2	3
Step	CMM (2mm Aq)	Option Code for Indoor Unit		
Hi	10.5	015771- 1583E6	015773- 158189	015773- 1583CE
Mid	9.0			
Low	7.5			

052

Static Pressure(mmAq)		0	2	4
Step	CMM (2mm Aq)	Option Code for Indoor Unit		
Hi	14.0	015773- 19812D	015773- 19814E	015774- 198071
Mid	12.5			
Low	11.0			

070

Static Pressure(mmAq)		0	2	4
Step	CMM (2mm Aq)	Option Code for Indoor Unit		
Hi	18.0	015774- 1C80A2	015774- 1C80D4	015774- 1C8206
Mid	16.0			
Low	14.0			

- Note**
- ◆ represents E. S. P(External Static Pressure) range of factory setting. You don't have to adjust the fan speed separately if the external static pressure of the installation place is in . When it is out of , input the appropriate option code.
 - ◆ If you input the inappropriate option code, error may occur or the air conditioner is out of order. The option code must be inputted correctly by the installation specialist or service agent.

Range of static pressure (Factory preset)

External static pressue(mmAq)		
Min.	Normal	Max.
0	2	3(** 035**)
		4(** 052/070 **)

Setting Up the Mode Option

Setting Option Setup Method

For example) Option Code : 085115-1d2340

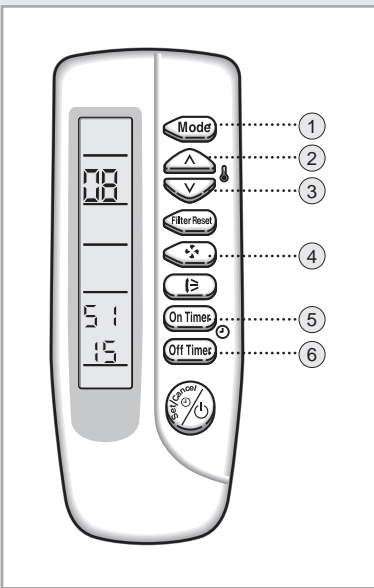
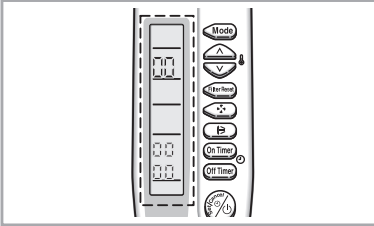

* Setting is not required if you want to input 00. 00 is displayed by default.

- 1 Prepare of the Option Setup mode.
 - a. Take out the batteries of remote control.
 - b. Press the button simultaneously and insert the battery again.
 - c. Make sure the remote control display shows as .

- 2 Enter the Option Setup mode and select your option according to the following procedure.

- ① The default value is . Otherwise, push the button to .

◆ Every time you press the button, the display panel reads 0 or 0 repeatedly.

- ② Press the button to set the display panel to 8.

◆ Every time you press the button, the display panel reads 0 → 1 → 2 → 3 → ... → 9 → A → b → c → d → repeatedly.

- ③ Press the button to set the display panel to 5.

◆ Every time you press the button, the display panel reads 0 → 1 → 2 → 3 → ... → 9 → A → b → c → d → repeatedly.

- ④ Press the button to set the display panel to 1.

◆ Every time you press the button, the display panel reads 0 → 1 → 2 → 3 → ... → 9 → A → b → c → d → repeatedly.

- ⑤ Press the button to set the display panel to 1.

◆ Every time you press the button, the display panel reads 0 → 1 → 2 → 3 → ... → 9 → A → b → c → d → repeatedly.

- ⑥ Press the button to set the display panel to 5.

◆ Every time you press the button, the display panel reads 0 → 1 → 2 → 3 → ... → 9 → A → b → c → d → repeatedly.

⑦ Press the **Mode** button, then the default value is 10.

00
00

⑧ Press the **▲** button to set the display panel to d.

◆ Every time you press the button, the display panel reads 0 → 1 → 2
3 → ... 9 → A → b → c → d → repeatedly.

⑨ Press the **▼** button to set the display panel to 2.

◆ Every time you press the button, the display panel reads 0 → 1 → 2
3 → ... 9 → A → b → c → d → repeatedly.

⑩ Press the **Filter Reset** button to set the display panel to 3.

◆ Every time you press the button, the display panel reads 0 → 1 → 2
3 → ... 9 → A → b → c → d → repeatedly.

⑪ Press the **On Timer** button to set the display panel to 4.

◆ Every time you press the button, the display panel reads 0 → 1 → 2
3 → ... 9 → A → b → c → d → repeatedly.

⑫ Press the **Off Timer** button to set the display panel to 0.

◆ Every time you press the button, the display panel reads 0 → 1 → 2
3 → ... 9 → A → b → c → d → repeatedly.

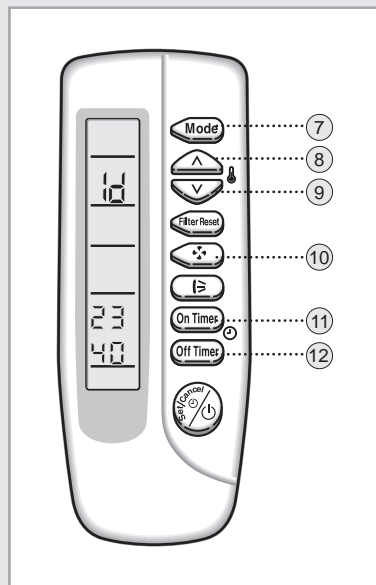

* Setting is not required if you want to input 0. 0 is displayed by default.

3 Check you made right selections upon completion of the selection.

a. Press the **Mode** button once to check the former part of option code you inputted.

◆ The display part shows 08.

51
15

b. Press the **Mode** button once more to check the latter part of option code you inputted.

◆ The display part shows 1d.

23
40

Setting Up the Mode Option (Continued)

4 Press the  button.

- ◆ When you press the  button towards the indoor unit, the sound 'Ding' or 'Diriring' is heard and the power indicator of the display flashes at the same time. Then the option code setting is completed.

(If the sound is not heard, press the  button again.)

5 Check the air conditioner operates normally.

- a. Remove the battery from the remote control.
- b. Insert the battery into the remote control again.
- c. Press the  towards the indoor unit.

Note

- ◆ If all indicators of the indoor unit are flashing, plug out the power plug and plug it in again. Then press the  button.

- ◆ If the air conditioner does not operate normally or all lamps indicators flash, check that the correct option code is set up.

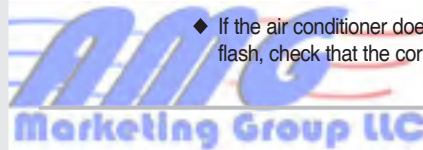

Option items

Model	SEG1	SEG2	SEG3	SEG4	SEG5	SEG6	SEG7	SEG8	SEG9	SEG10	SEG11	SEG12
EH035CAV	0	1	5	7	7	3	1	5	8	1	8	9
EH052CAV	0	1	5	7	7	3	1	9	8	1	4	E
EH070CAV	0	1	5	7	7	4	1	C	8	0	d	4

* This option code is pre-set when indoor unit is produced at the factory.

Assigning Address to Indoor Unit

- 1 Before installing the indoor unit, assign an address to the indoor unit according to the air conditioning system plan.
- 2 The address of the indoor unit is assigned by adjusting MAIN(SW02) and RMC(SW04) rotary switches.

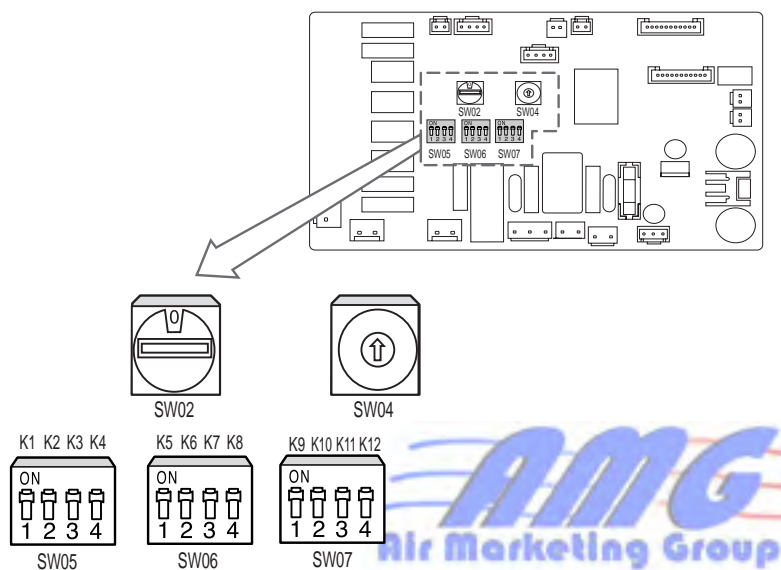

- 3 It is required to set the RMC address if you install the wired remote controller and/or the centralized controller.
- 4 If you install optional accessories such as the wired remote controller, centralized controller, etc. see an appropriate installation manual.
- 5 If an optional accessory is not installed, you do not have to set the RMC address. However, adjust K1 and K2 switches of the SW05 DIP switch to "ON" position in this case.

Additional Functions

K5 K6 K7 K8

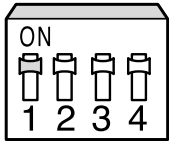

SW06

K5 K6 K7 K8

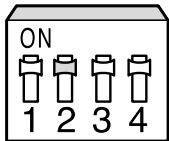

SW06

K5 K6 K7 K8

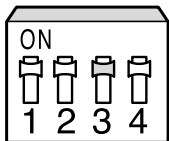

SW06

Compensation for lost temperature in heating operation

- ◆ Reduces the difference between an actual room temperature and a sensed temperature by the air conditioner when heating.

Switch No.	Switch ON	Switch OFF
K5	2°C compensation	5°C compensation

Adjusting filter cleaning cycle

- ◆ You can adjust the cycle for filter sign indicator.

Switch No.	Switch ON	Switch OFF
K6	1000 hours	2000 hours

Hot water heater

- ◆ You must adjust the K7 when you install the hot water heater.

Switch No.	Switch ON	Switch OFF
K7	No use of hot water heater	Use of hot water heater

External Control

- You must adjust the K11 when you use external control.

Switch No.	Switch ON	Switch OFF
K11	No use of external control	Use of external control

- You can use external control when the K11 switch is turned off.

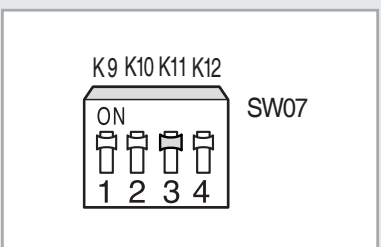

Operation ON/OFF Function

Connector No.	SHORT	OPEN
CN83(RED)	Operation ON	Operation OFF

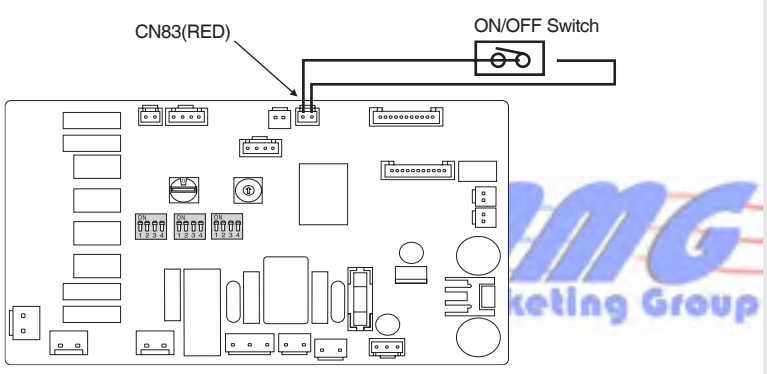

Operation State Display

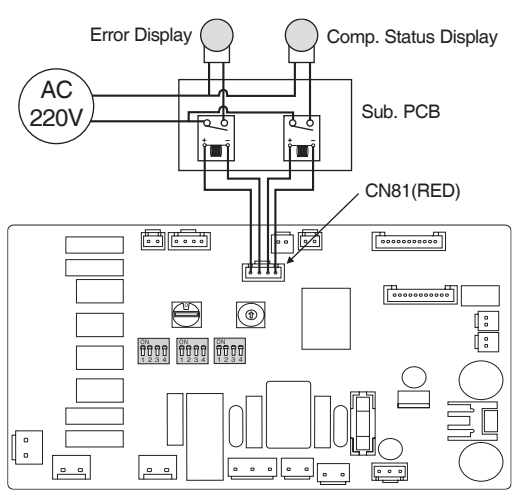

Connector No.	Function
PIN #1 and #2 of CN81(RED)	+12V Out if any error occurs
PIN #3 and #4 of CN81(RED)	+12V Out when the compressor is operating



Filter Replacement (Optional)

There are 2 kinds of air inlet as follows; they should be installed according to the following instruction.

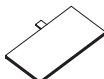
Accessories

Filter	Cap filter	Bracket filter
2	1	2
		

Appearance

When air enters back side

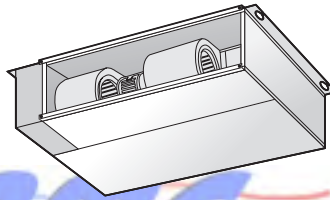

When air enters bottom side

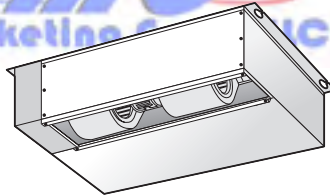

Installation Diagram

When air enters back side

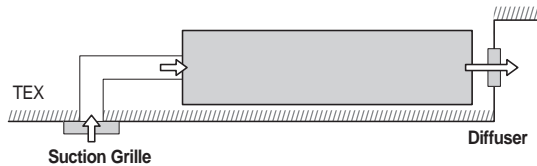

When air enters bottom side

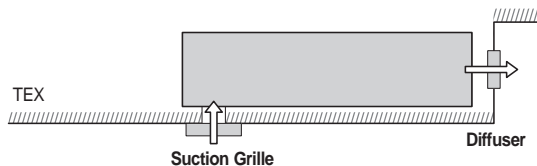

Installation Method

The shape and installation method are subject to change according to the models.

1 When air enters back side

Fix the indoor unit support to the top of the air inlet with screws.

When air enters bottom side

Fix the cover to the back of the product with screws.

2 Put pads on the support.

3 Put the indoor unit on the support.



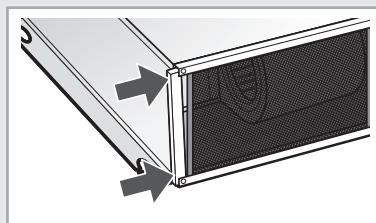
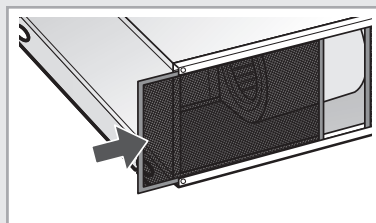
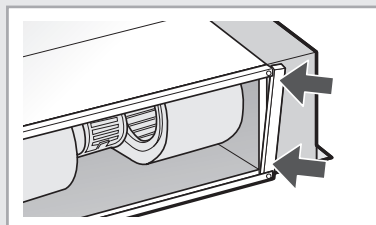
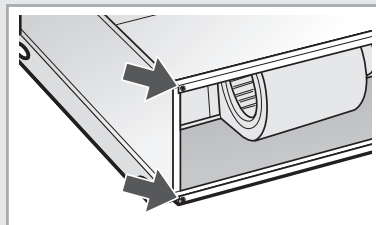

4 Insert another pad between the indoor unit and the support.



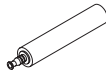

AMG
Air Marketing Group

Drain pump Installation (Optional)

Accessories

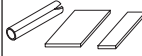
Drain pump & Float switch	Flexible hose pump	Flexible hose	Drain cap
1	1	1	1
			

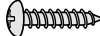
Clamp	Insulation	Cable-tie	Screw
1	1	4	3
			

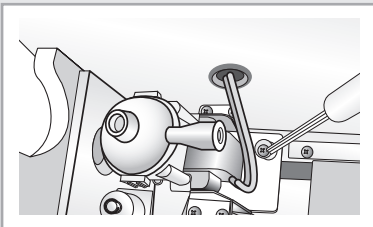

- 1 Separate the bracket of the indoor unit and fix it with the drain pump.

Note Fix it with 3 screws.

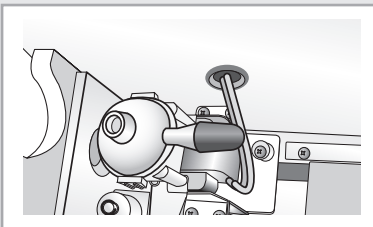
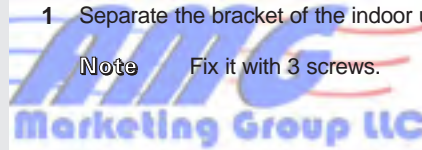

- 2 Connect the drain pump and the flexible hose pump.

Note

- ◆ Insert the flexible hose pump into a hole of the indoor unit.
- ◆ Connect the flexible hose to the connection of the drain pump with a clamp.
- ◆ Change a clamp under the drain pump.

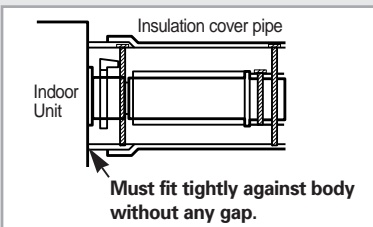

- 3 Connect the flexible hose to the flexible hose pump.

Note

- ◆ Check a rubber ring is installed to the drain pump.
- ◆ Stop the drain hole of the drain cushion with a drain cap.
- ◆ Insulate the flexible hose.

- 4 Connect the float switch of the drain pump(Yellow) and power supply unit(Black) to the PCB of the indoor unit.

Note Use a cable tie for managing the drain pump.

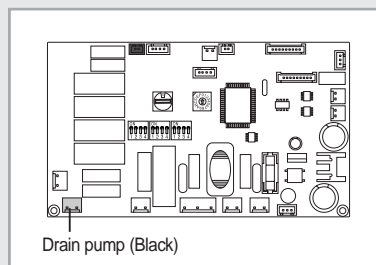

- 5 Adjust K4 DIP switch(SW05) to the "OFF" position.

Switch No.	Switch Position	Using Drain Pump
K4	ON	X
	OFF	O

Note Wrap the drain tube outlet on the right and left side of the indoor unit with an insulating materials.

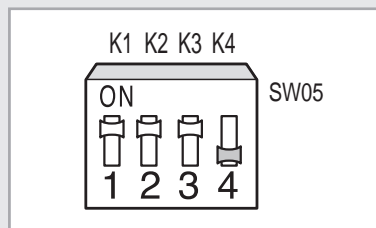

- 6 Check water leakage of the drain hose port and the drain pipe after completing installation.

CAUTION

- ◆ **The drain pump must be installed by an installation specialist.**
- ◆ **Before installing the optional kits, ensure that you have turned off the main power.**
- ◆ **You should use the original drain pump made in Samsung. If you assemble the drain pump, you are responsible for every claim caused from the drain pump you assembled.**
- ◆ **After completing the drain pump, fix the connection port of the drain hose with insulation.**



Troubleshooting

■ Detection of errors

- ◆ If an error occurs during the operation, an LED flickers and the operation is stopped except the LED.
- ◆ If you re-operate the air conditioner, it operates normally at first, then detect an error again.

LED Display on the receiver & display unit

■ LED Display

Abnormal conditions	Indicators					Remark
	Concealed Type		Green	Red	Standard Type	
	Green	Red				
	Standard Type	Concealed Type	Green	Red	Standard Type	
Power reset	●	X	X	X	X	
Error of temperature sensor in indoor unit (OPEN/SHORT)	X	X	●	X	X	
Error of heat exchanger sensor in indoor unit	●	X	●	X	X	
Error of outdoor temperature sensor Error of the condensor temperature sensor Error of the discharge temperature sensor	X	X	X	●	X	
Indoor and outdoor unit time out Abnormal data reception more than 60 packet Indoor unit is not connected Communication error between the outdoor unit Main-Inverter Micom (After 1 minute of Main-Inverter detection)	X	X	●	●	X	1. Indoor unit error (Display is unrelated with operation) 2. Outdoor unit error (Display is unrelated with operation)

● On ● Flickering X Off

- ◆ If you turn off the air conditioner when the LED is flickering, the LED is also turned off.
- ◆ If you re-operate the air conditioner, it operates normally at first, then detects an error again.

LED Display

Abnormal conditions	Indicators					Remark
	Concealed Type		Standard Type	Fan	Error	
	Green	Red				
	Power	Gas	Power	Fan	Error	
[Self diagnosis] Power voltage detection between indoor and outdoor unit communication cable						
[Self diagnosis] Outdoor unit refrigerant leakage (Gas leak)						
[Self diagnosis] Outdoor fan restriction error						
[Inverter] Inverter compressor operation failure						
[Inverter] DC peak error						
[Inverter] DC Link voltage 150V or less, 410V or more	X	X	●	●	●	
[Inverter] Compressor rotation error						
[Inverter] Electric current error						
[Inverter] DC Link sensor error						
[Inverter] EEPROM READ/WRITE error						
[Inverter] Inverter zero-crossing error						
Setting the outdoor unit capacity option error						
Detection of the float switch	X	X	X	●	●	
Error of setting option switches for optional accessories	X	X	●	X	●	
EEPROM error	●	X	●	●	X	
EEPROM option error	●	●	●	●	●	

● On ● Flickering X Off

- ◆ If you turn off the air conditioner when the LED is flickering, the LED is also turned off.
- ◆ If you re-operate the air conditioner, it operates normally at first, then detect an error again.

Troubleshooting (Continued)

Wired remote controller

- ◆ If an error occurs,  is displayed on the wired remote controller.
If you would like to see an error code, press the Test button.

Outdoor unit

Display	Explanation	Remark
101	Indoor unit Communication Error	Communication ERROR
102	Indoor/Outdoor unit Communication Time Out Error	
	60 Packet Over data	
201	Indoor unit is not connected	
203	Communication Error between Outdoor Main and Inverter Micom (Occurred after 1 minute detection in Main and Inverter)	Indoor Sensor Error
121	Indoor Temp. Sensor (OPEN/SHORT ERROR)	
122	Indoor Unit Eva in sensor (OPEN/SHORT ERROR)	
128	Indoor Unit Eva in sensor Separation	
221	Outdoor Temp. Sensor Error (OPEN/SHORT ERROR)	Outdoor Sensor Error
230	COND Temp. Sensor Error (OPEN/SHORT ERROR)	
260	Inverter Compressor Discharge Temp. sensor Error (OPEN/SHORT ERROR)	
453	Indoor Float S/W 2 nd Detection	
460	Outdoor unit-Indoor unit Communication wire Voltage Detection	Self Diagnosis Error
554	Outdoor unit Refrigerant Full Leakage (Gas Leak)	
458	Outdoor door Fan Error	
461	[Inverter] Inverter Comp. Start Failure	Outdoor Unit Protection Control Error
464	[Inverter] DC PEAK Error	
466	[Inverter] DC LINK Voltage 150V below, 410V Over	
467	[Inverter] Comp. Rotation Error	
468	[Inverter] Current Sensor Error	
469	[Inverter] DC LINK Sensor Error	
471	[Inverter] EEPROM READ/WRITE Error	
472	[Inverter] Inverter ZEROCROSSING Error	
556	Outdoor unit Capacity Setup Option Error	Wired Remote Control Error
601	Wired Liquid Crystal ↔ Indoor unit Comm. Error	
602	Master Wired Liquid Crystal ↔ Slave Liquid Crystal Comm. Error	
606	Wired Liquid Crystal COM1/COM2 Cross Error	
EF	Error of setting option for wired remote controller COM2	

Indoor unit





Display	Explanation
E101	Indoor unit communication reception error
E102	Communication error between the outdoor and indoor unit
E121	Indoor unit temperature sensor (Short/Open)
E122	Indoor unit Eva In sensor (Short/Open)
E123	Indoor unit Eva Out sensor (Short/Open)
E128	Indoor unit Eva In sensor secession
E129	Indoor unit Eva Out sensor secession
E130	Indoor Eva In and Out sensor secession error
E131	Secondary(Electronic)heater sensor 1 error
E132	Secondary(Electronic)heater sensor 2 error
E133	Secondary(Electronic)heater sensor 3 error
E153	Indoor unit float S/W 2nd detection
E154	Indoor fan error
E161	Mixed operation error
E162	EEPROM error
E163	EEPROM option setting error
E164	Error regarding special sales taxes
E165	Electronic heater discharge temperature protection error
E166	Electronic heater windless error
E201	Indoor unit number setting error(The outdoor unit informs the error)

Parts list

Receiver & Display Unit Accessories

Concealed type

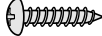
◆ Receiver & display unit





Receiver & display unit	STS 2S-2x10 tapped screw	2S-4x12 tapped screw	Owner's instructions	Installation manual
1	4	2	1	1
				

◆ Wire kit

Wire kit
1

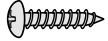
Standard type







◆ Receiver & display unit

Receiver & display unit	M4x16 tapped screw	Cable-tie	Cable clamp	Owner's instructions	Installation manual
1	7	2	5	1	1
					









◆ Wire kit

Wire kit
1

Wireless Remote Controller Accessories

Wireless remote controller	Battery	Remote control holder	STS 2S-2x10 tapped screw	Owner's instructions	Installation manual
1	2	1	2	1	1
					

Wired Remote Controller Accessories

Wired remote controller	Cable-tie	Cable clamp	M4x16 tapped screw	Indoor unit power drawing cable
1	2	5	7	1
				
	Communication cable of the wired remote controller	Wire joint	Owner's instructions	Installation manual
	1	1	1	1
				





INSTALLATION MANUAL

UH035CAV
UH052CAV
UH070CAV

ENGLISH

ESPAÑOL

FRANÇAIS

System Air Conditioner
(Cooling and Heating)

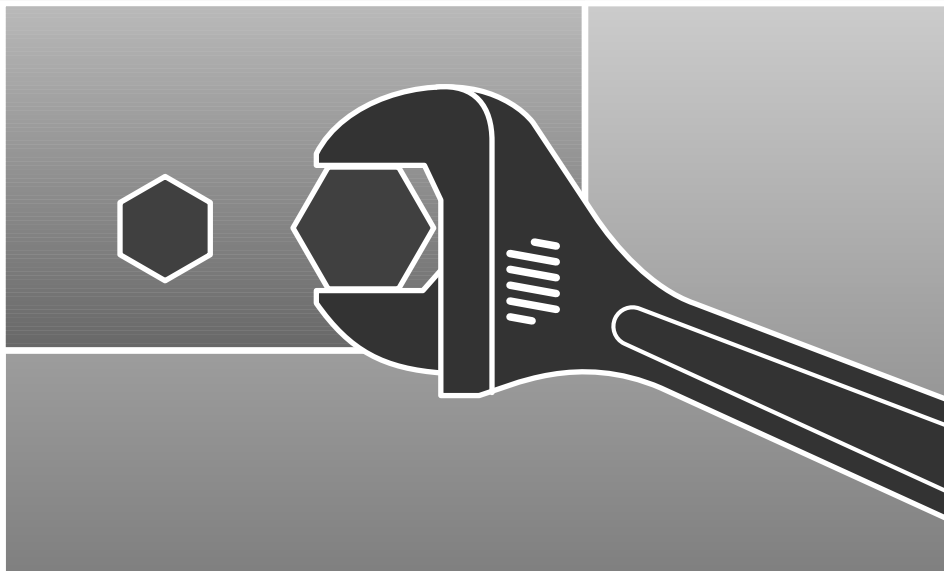

Safety Precautions

The following safety precautions must be taken when using your air conditioner.



WARNING

Risk of electric shock. • Can cause injury or death. • Disconnect all remote electric power supplies before servicing, installing or cleaning. • This must be done by the manufacturer or its service agent or a similar qualified person in order to avoid a hazard.

INSTALLING THE UNIT

- ◆ The unit should not be installed by the user. Ask the dealer or authorized company to install the units except room air conditioners for the U.S.A and Canada area.
- ◆ If the unit is installed improperly, water leakage, electric shock or fire may result.
- ◆ Mount with the lowest moving parts at least 2.5 m above the floor or grade level. (If applicable)
- ◆ The manufacturer does not assume responsibility for accidents or injury caused by an incorrectly installed air conditioner. If you are unsure about installation, contact an installation specialist.
- ◆ When installing the built-in type air conditioner, keep all electrical cables such as the power cable and the connection cord in pipe, ducts, cable channels e.t.c to protect them against liquids, outside impacts and so on.

POWER SUPPLY LINE, FUSE OR CIRCUIT BREAKER

- ◆ If the power cord of this air conditioner is damaged, it must be replaced by the manufacturer, its service agent or similarly qualified persons in order to avoid a hazard.
- ◆ The unit must be plugged into an independent circuit if applicable or connect the power cable to the auxiliary circuit breaker. An all pole disconnection from the power supply must be incorporated in the fixed wiring with a contact opening of >3mm.
- ◆ Do not use an extension cord with this product.
- ◆ If the unit is equipped with a power supply cord and a plug, the plug must be accessible after installation.
- ◆ The air conditioner must be installed in accordance with national wiring regulations and safety regulations wherever applicable.

Contents

■ Preparation for outdoor unit installation	5
■ Deciding on where to install the outdoor unit	6
■ Outdoor unit installation	9
■ Connecting the cable	10
■ Connecting the refrigerant pipe	13
■ Connecting up and removing air In the circuit	14
■ Cutting / Flaring the pipes	15
■ Performing leak tests	16
■ Connecting the drain hose to the outdoor unit	16
■ Insulation	16
■ Using stop valve	17
■ Adding refrigerant	18
■ Checking correct grounding	20
■ Setting up option switches	21
■ Testing operations	22
■ Troubleshooting	23
■ Parts list	24

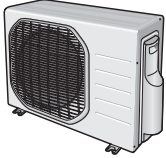
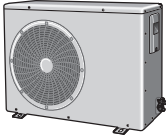
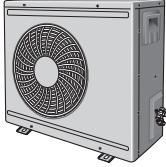

Type of outdoor unit			A	B	C
Design					
Model	Heat pump	R410A	UH035CAV	UH052CAV	UH070CAV



Preparation for outdoor unit installation

Moving the Outdoor Unit by Wire Rope

Fasten the outdoor unit by two 8m or longer wire ropes as shown at the figure. To prevent from damage or scratches, insert a piece of cloth between the outdoor unit and rope, then move the unit.

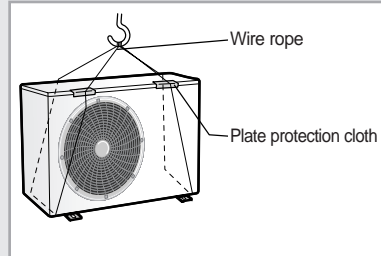

Deciding on where to install the outdoor unit

Outdoor Unit

- ◆ The outdoor unit must not be placed on its side or upside down, as the compressor lubrication oil will run into the cooling circuit and seriously damage the unit.
- ◆ Choose a location that is dry and sunny, but not exposed to direct sunlight or strong winds.
- ◆ Do not block any passageways or thoroughfares.
- ◆ Choose a location where the noise of the air conditioner when running and the discharged air do not disturb any neighbours.
- ◆ Choose a position that enables the pipes and cables to be easily connected to the indoor unit.
- ◆ Install the outdoor unit on a flat, stable surface that can support its weight and does not generate any unnecessary noise and vibration.
- ◆ Position the outdoor unit so that the air flow is directed towards the open area.
- ◆ Maintain sufficient clearance around the outdoor unit, especially from a radio, computer, stereo system, etc.

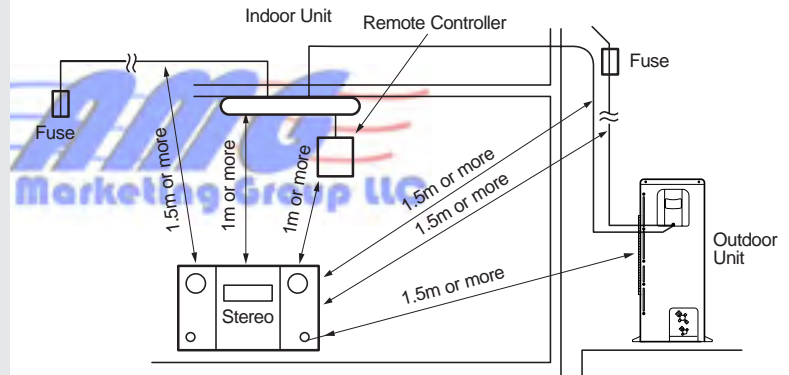

- ◆ If the outdoor unit is installed at a height, ensure that its base is firmly fixed in position.
- ◆ Make sure that the water dripping from the drain hose runs away correctly and safely.

CAUTION

- ◆ **You have just purchased a system air conditioner and it has been installed by your installation specialist.**
- ◆ **This device must be installed according to the national electrical rules.**

Space Requirements for Outdoor Unit

When installing 1 outdoor unit

Unit : mm

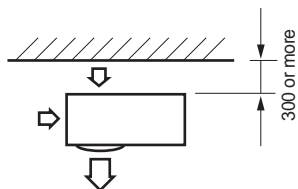

* When the air outlet is opposite the wall

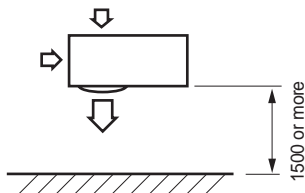

* When the air outlet is towards the wall

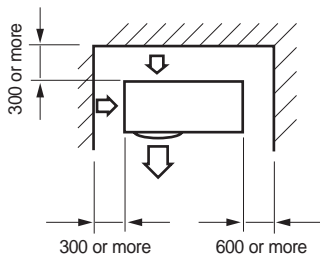

* When 3 sides of the outdoor unit are blocked by the wall

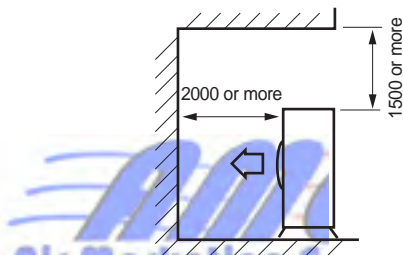

* The upper part of the outdoor unit and the air outlet is towards the wall

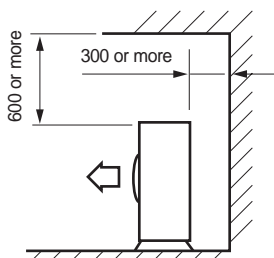

* The upper part of the outdoor unit and the air outlet is opposite the wall

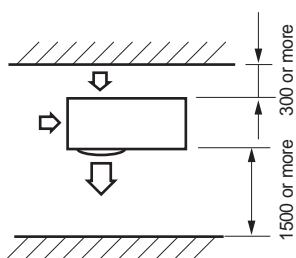

* When front and rear side of the outdoor unit is towards the wall

Deciding on where to install the outdoor unit (Continued)

When installing more than 1 outdoor unit

Unit : mm

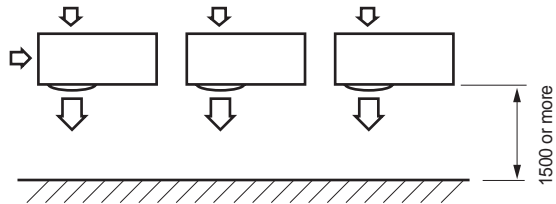

* When the air outlet is towards the wall

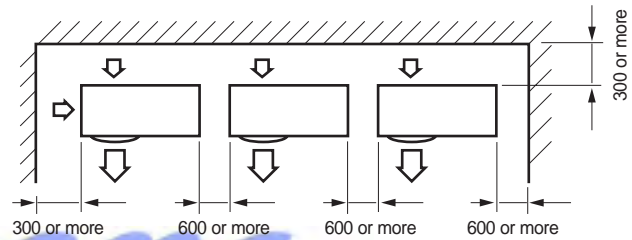

* When 3 sides of the outdoor unit are blocked by the wall

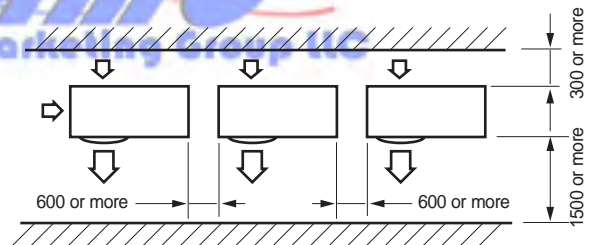

* When front and rear side of the outdoor unit is towards the wall

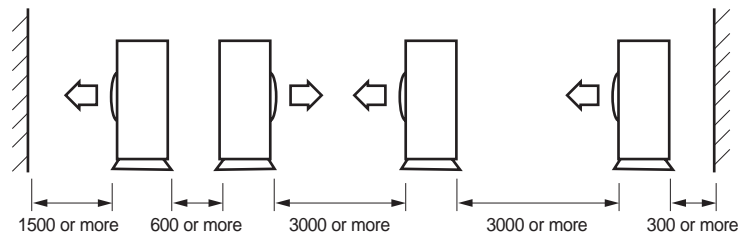

* When front and rear side of the outdoor unit is towards the wall

Outdoor unit installation

The outdoor unit must be installed on a rigid and stable base to avoid any increase in the noise level and vibration, particularly if the outdoor unit is to be installed in a location exposed to strong winds or at a height, the unit must be fixed to an appropriate support(wall or ground).

Fix the outdoor unit with anchor bolts.

Note ♦ The anchor bolt must be 20mm or higher from the base surface.

Unit : mm

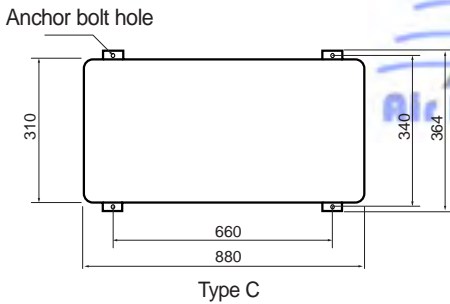
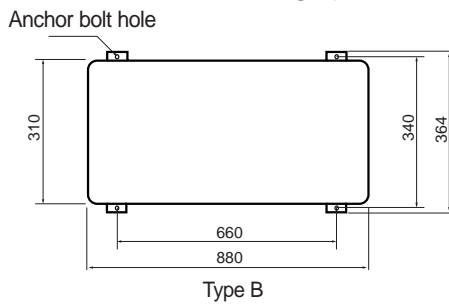
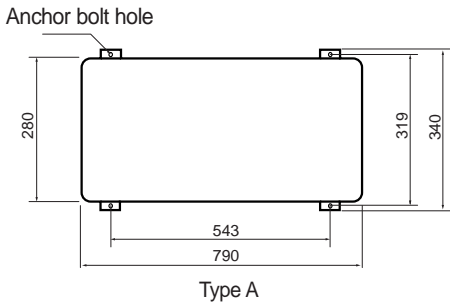

CAUTION

- ♦ **Make a drain outlet around the base for outdoor unit drainage.**
- ♦ **If the outdoor unit is installed on the roof, you have to check the ceiling strength and waterproof the unit.**

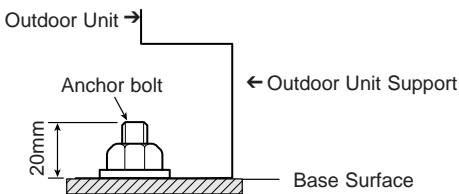

Connecting the cable

Two electronic cables must be connected to the outdoor unit.

- ◆ The connection cord between indoor unit and outdoor unit.
- ◆ The power cable between outdoor unit and auxiliary circuit breaker.
- ◆ Specially for Russian and European market, before installation, the supply authority should be consulted to determine the supply system impedance to ensure compliance.

Example of Air Conditioner System

When using ELB for 1 phase

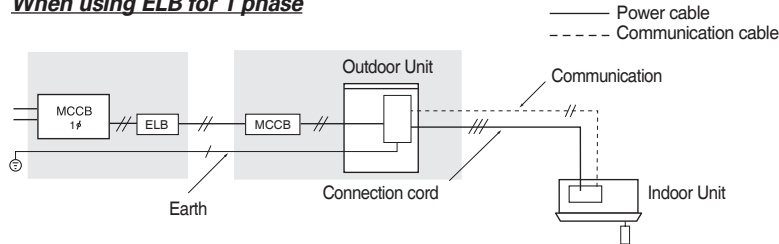

* If an outdoor unit is installed in a place in danger of an electric leak or submergence, you must install the ELB.

Power Cable Specifications

Type of outdoor unit	Power Supply											
	3 Phase						Single Phase					
	Power Supply	Max/Min (V)	MCCB	ELB	Power Cable	Length	Power Supply	Max/Min (V)	MCCB	ELB	Power Cable	Length
A	-	-	-	-	-	-	208-230V~/60Hz	187/253	Frame: 30A Trip: 20A	20A	2.5mm ² , 3 Wires	65.6ft or less
B	-	-	-	-	-	-	208-230V~/60Hz	187/253	Frame: 30A Trip: 25A	25A	2.5mm ² , 3 Wires	98.4ft or less
C	-	-	-	-	-	-	208-230V~/60Hz	187/253	Frame: 30A Trip: 30A	30A	2.5mm ² , 3 Wires	98.4ft or less

* The power cable is not supplied with air conditioner.

* For power cable, use the grade H07RN-F or H05RN-F materials.

Between Indoor and Outdoor Connection Cord Specifications

Type	Power Supply (Single Phase)			Communication Cable
	Power Supply	Max/Min(V)	Connection Wire	
A	208-230V~/60Hz	±10%	0.75mm ² 3 wires	0.75mm ² 2 wires
B			0.75mm ² 3 wires	0.75mm ² 2 wires
C				

* For connection cord, use the grade H07RN-F or H05RN-F materials.

Wiring Diagram of Power Cable

When using ELB for 1 phase

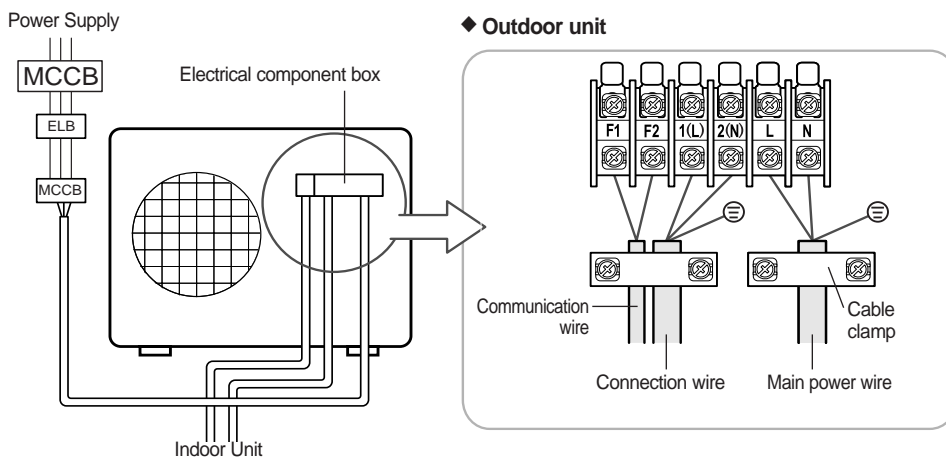

CAUTION

- ◆ You should connect the power cable into the power cable terminal and fasten it with a clamp.
- ◆ The unbalanced power must be maintained within 2% of supply rating.
- If the power is unbalanced greatly, it may shorten the life of the condenser. If the unbalanced power is exceeded over 4% of supply rating, the indoor unit is protected, stopped and the error mode indicates.
- ◆ To protect the product from water and possible shock, you should keep the power cable and the connection cord of the indoor and outdoor units in the iron pipe.
- ◆ Connect the power cable to the auxiliary circuit breaker. An all pole disconnection from the power supply must be incorporated in the fixed wiring ($\geq 3\text{mm}$).
- ◆ Must keep the cable in a protection tube.
- ◆ Keep distances of 50mm or more between power cable and communication cable.

Connecting the cable (Continued)

Wiring Diagram of Connection Cord

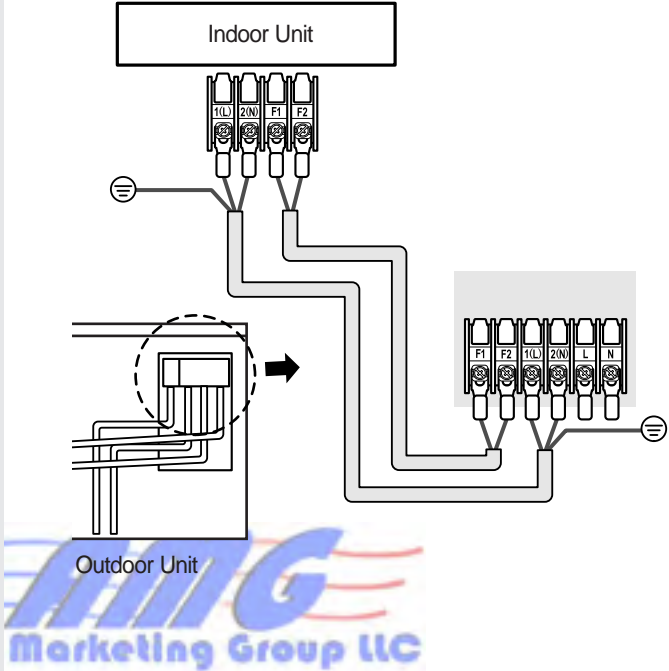

Connecting the refrigerant pipe

Refrigerant Piping System

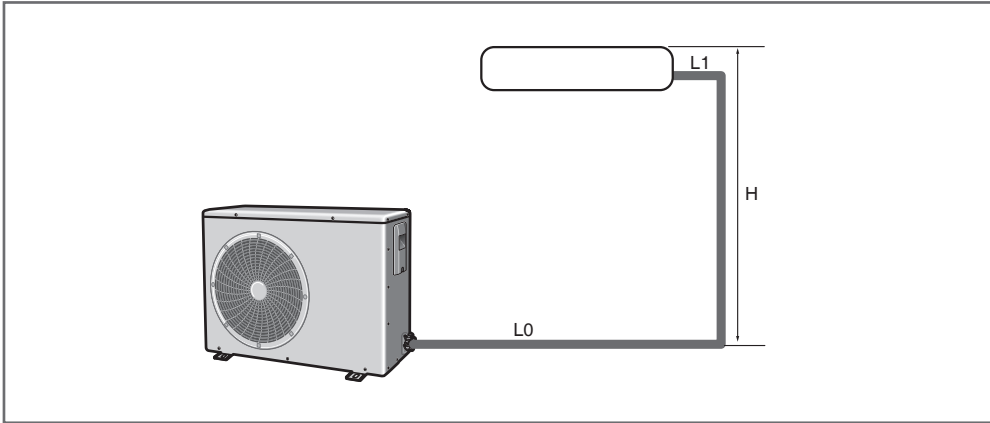

Refrigerant piping system table			Pipe length or height	
			UH035CAV	UH052CAV UH070CAV
Max. allowable length	Actual pipe length	$L_0 + H + L_1$	65.6ft or less	98.4ft or less
Allowable height length	Actual pipe length	H	39.4ft or less	49.2ft or less

Connecting up and removing air In the circuit

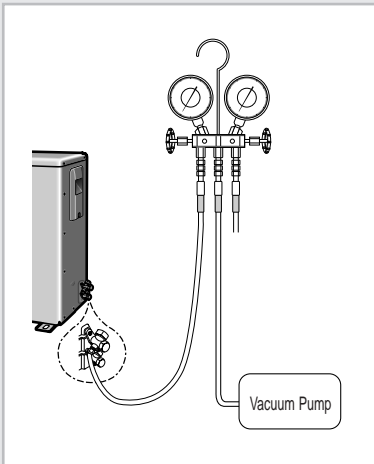
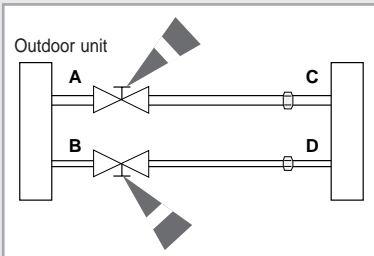

* The designs and shape are subject to change according to the model.

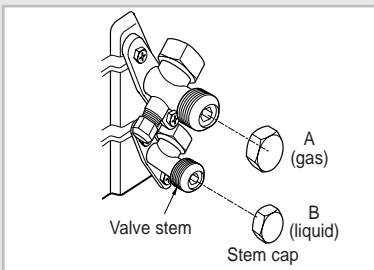

The air in the indoor unit and in the pipe must be purged. If air remains in the refrigeration pipes, it will affect the compressor, reduce to cooling capacity and could lead to a malfunction. Refrigerant for air purging is not charged in the outdoor unit. Use Vacuum Pump as shown at the figure.

1 Connect each assembly pipe to the appropriate valve on the outdoor unit and tighten the flare nut.

2 Referring to the illustration opposite, tighten the flare nut on section B first manually and then with a torque wrench, applying the following torque.

Outer Diameter	Torque (kgf•cm)
6.35 mm (1/4")	140~170
9.52 mm (3/8")	250~280
12.70 mm (1/2")	380~420
15.88 mm (5/8")	440~480
19.05 mm (3/4")	990~1210
22.23 mm (7/8")	990~1210

3 Connect the charging hose of low pressure side of manifold gauge to the packed valve having a service port as shown at the figure.

4 Open the valve of the low pressure side of manifold gauge counterclockwise.

5 Purge the air from the system using vacuum pump for about 10 minutes.
 ◆ Close the valve of the low pressure side of manifold gauge clockwise.
 ◆ Make sure that pressure gauge show -0.1MPa(-76cmHg) after about 10 minutes.

This procedure is very important in order to avoid gas leak.

- ◆ Turn off the vacuum pump.
- ◆ Remove the hose of the low pressure side of manifold gauge.

6 Set valve cork of both liquid side and gas side of packed valve to the open position.

7 Mount the valve stem nuts and the service port cap to the valve, and tighten them at the torque of 183kgf•cm with a torque wrench.

8 Check for gas leakage.
 ◆ At this time, especially check for gas leakage from the 3-way valve's stem nuts(A port), and from the service port cap.

Cutting / Flaring the pipes

1 Make sure that you have the required tools available (pipe cutter, reamer, flaring tool and pipe holder).

2 If you wish to shorten the pipes, cut it with a pipe cutter, taking care to ensure that the cut edge remains at a 90° angle with the side of the pipe. Refer to the illustrations below for examples of edges cut correctly and incorrectly.

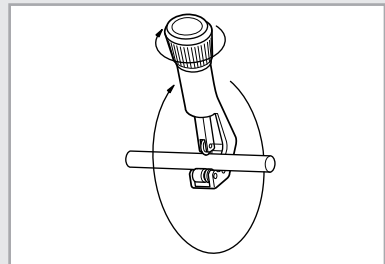
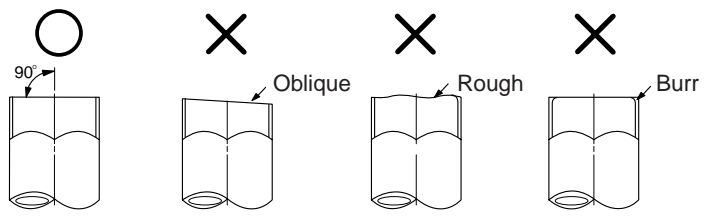

3 To prevent any gas from leaking out, remove all burrs at the cut edge of the pipe, using a reamer.

4 Slide a flare nut on to the pipe and modify the flare.

Outer Diameter(D)	Depth (A)
6.35 mm (1/4")	1.3mm
9.52 mm (3/8")	1.8mm
12.70 mm (1/2")	2.0mm
15.88 mm (5/8")	2.2mm
19.05 mm (3/4")	2.2mm
22.23 mm (7/8")	2.2mm

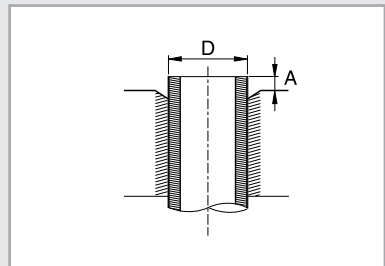

5 Check that the flaring is correct, referring to the illustrations below for examples of incorrect flaring.

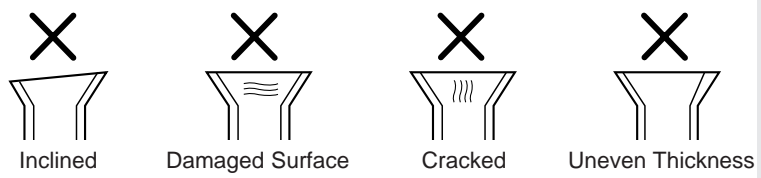

6 Align the pipes and tighten the flare nuts first manually and then with a torque wrench, applying the following torque.

Outer Diameter	Torque (kgf•cm)
6.35 mm (1/4")	140~170
9.52 mm (3/8")	250~280
12.70 mm (1/2")	380~420
15.88 mm (5/8")	440~480
19.05 mm (3/4")	990~1210
22.23 mm (7/8")	990~1210

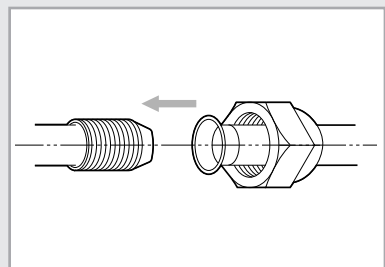

CAUTION
 ♦ In case of welding the pipe, you must weld with nitrogen gas blowing.

Performing leak tests

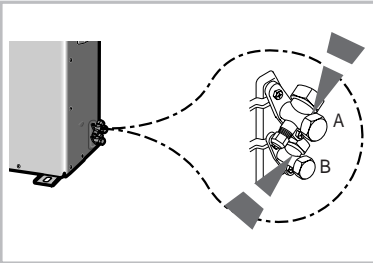

* The designs and shape are subject to change according to the model.

Before completing the installation (insulation of the hose and piping), you must check that there are no gas leaks.

To check for gas leaks on the...

Then, using a leak detector, check the...

Outdoor unit

Valves on sections A and B.

Connecting the drain hose to the outdoor unit

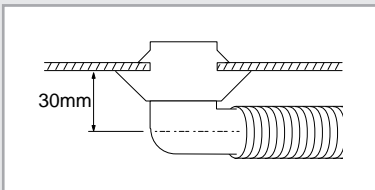
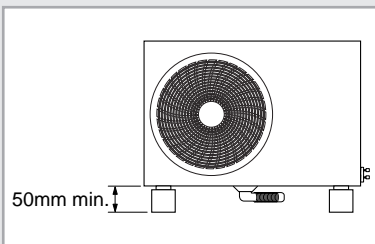

When using the air conditioner in the heating mode, ice may accumulate. During de-icing, the condensed water must be drained off safely. Consequently, you must install a drain hose on the outdoor unit, following the instructions below.

- 1 Make space more than 50mm between the bottom of the outdoor unit and the ground for installation of the drain hose, as shown in figure.
- 2 Insert the drain plug into the hole on the underside of the outdoor unit.
- 3 Connect the drain hose to the drain plug.
- 4 Ensure that the drained water runs off correctly and safely.

Insulation

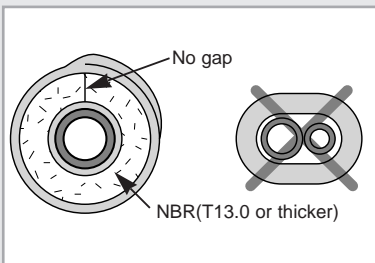

Once you have checked that there are no leaks in the system, you can insulate the piping and hose.

- 1 To avoid condensation problems, place an insulator around each refrigerant pipe.

Note

- ◆ When insulate the pipe, be sure to overlap the insulation.
- ◆ You have to use more than 120°C insulation(T13.0 or thicker Acrylonitrile Butadien Rubber) for the gas refrigerant pipe.

Using stop valve

To Open the Stop Valve

1 Open the cap and turn the stop valve counterclockwise by using a hexagonal wrench.

2 Turn it until the axis is stopped.

- Note**
- ◆ Do not apply excessive force to the stop valve and always use special instruments. Otherwise, the stopping box can be damaged and the back sheet can leak.
 - ◆ If the watertight sheet leaks, turn the axis back by half, tighten the stopping box, then check the leakage again. If there is no leakage any more, tighten the axis entirely.

3 Tighten the cap securely.

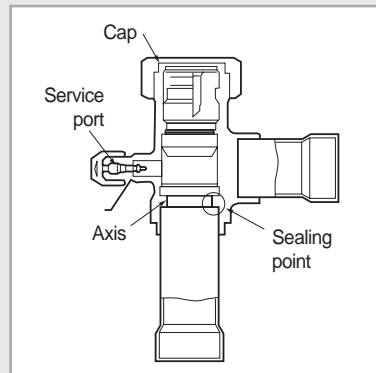

To Close the Stop Valve

1 Remove the cap.

2 Turn the stop valve clockwise by using a hexagonal wrench.

3 Tighten the axis until the valve reached the sealing point.

4 Tighten the cap securely.



CAUTION

- ◆ *When you use the service port, always use a charging hose, too.*
- ◆ *Check the leakage of refrigerant gas after tightening the cap.*
- ◆ *Must use a spanner and wrench when you open/tighten the stop valve.*

Adding refrigerant

The outdoor unit is loaded with sufficient refrigerant for the standard piping. Thus, refrigerant must be added if the piping is lengthened. This operation can only be performed by a qualified refrigeration specialist. For quantity of adding refrigerant, refer to page 19.

1 Check that the stop valve is closed entirely.

2 Charge the refrigerant through the service port of liquid stop valve.

Note ♦ Do not charge the refrigerant through the gas side service port.

3 If you cannot charge the refrigerant according to the upper steps, following these:

3-1 Open both liquid stop valve and gas stop valve.

3-2 Operate the air conditioner by pressing the K2 key on the outdoor unit PCB.

3-3 About 30 minutes later, charge the refrigerant through the service port of gas stop valve.

Note ♦ If necessary, refer to the pressure table classified by outdoor temperature.

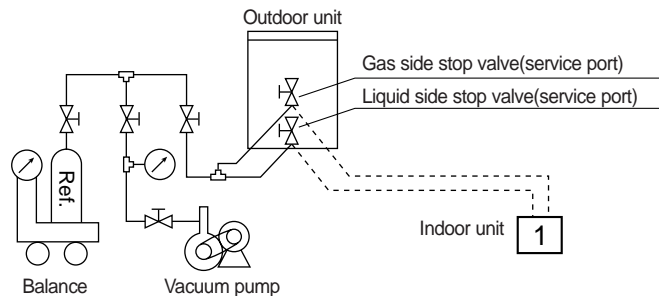

How to Calculate the Quantity of Adding Refrigerant

If you have used more than "P", add "Q" of refrigerant for extra meter.

(For maximum piping length and height, refer to page 13)

The quantity of additional refrigerant is variable according to the installation situation. Thus, make sure the outdoor unit situation before adding refrigerant. This operation can only be performed by a qualified refrigeration specialist.

Model	"Q"(R410A)			"P"
Indoor unit \ Outdoor unit	EH035CAV	EH052CAV	EH070CAV	
UH035CAV	0-49.2ft : - 49.2-65.6 ft : 0.16 oz/ft	-	-	24.6ft
UH052CAV	-	0.21 oz/ft	-	24.6ft
UH070CAV	-	-	0.11 oz/ft	24.6ft

i.e. 1 indoor unit



Piping length "a"	Additional charging amount	
	UH052CAV	UH070CAV
16.4ft	-	-
24.6ft	-	-
31.2ft	1.41oz	1.06oz

Checking correct grounding

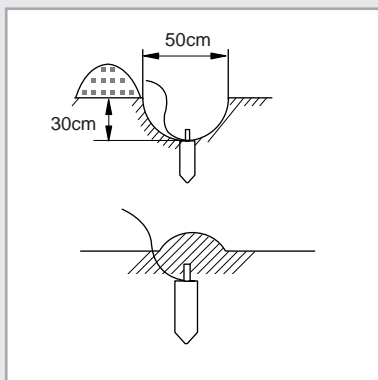
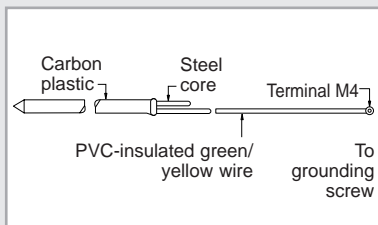

If the power distribution circuit does not have an earth or the ground does not comply with specifications, an grounding electrode must be installed. The corresponding accessories are not supplied with the air conditioner.

1 Select an grounding electrode that complies with the specifications given in the illustration.

- 2 Determine a suitable location for the grounding electrode:
- ◆ In damp hard soil rather than loose sandy or gravel soil that has a higher grounding resistance
 - ◆ Away from underground structures or facilities, such as gas pipes, water pipes, telephone lines and underground cables
 - ◆ At least two metres away from a lightning conductor grounding electrode and its cable

Note ◆ The grounding wire for the telephone line cannot be used to ground the air conditioner.

3 Finish wrapping insulating tape around the rest of the pipes leading to the outdoor unit.

AMG
Marketing Group LLC

- 4 Install a green/yellow coloured grounding wire:
- ◆ If the grounding wire is too short, connect an extension lead, in a mechanical way and wrapping it with insulating tape (do not bury the connection)
 - ◆ Secure the grounding wire in position with staples

Note ◆ If the grounding electrode is installed in an area of heavy traffic, its wire must be connected securely.

5 Carefully check the installation, by measuring the grounding resistance with a ground resistance tester. If the resistance is above required level, drive the electrode deeper into the ground or increase the number of grounding electrodes.

6 Connect the grounding wire to the electrical component box inside of the outdoor unit.

Setting up option switches

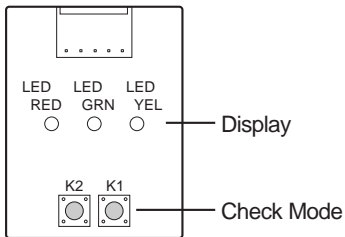

Display Pattern	Red	Green	Yellow	Meaning
1	●	◎	○	Normal Mode
2	◎	◎	○	Test Operation at Cooling Mode
3	◎	◎	◎	Test Operation at Heating Mode

○ Off ◎ Blink ● On

Number of Press time (K1)	Operation	Operation Condition	LED Pattern
1	Test Mode	Normal Mode	LED OFF
2	Test operation of Heating Mode	Test Mode	3 pattern
3	Test operation of Cooling Mode	Heating Mode	2 pattern
4	EXIT	Cooling Mode	1 pattern

Testing operations

-
- 1 Check the power supply between the outdoor unit and the auxiliary circuit breaker.
 - ◆ Single phase power supply: L, N
-
- 2 Check the indoor unit.
 - 2-1 Check that you have connected the power and communication cables correctly. (If the power cable and communication cables are mixed up or connected incorrectly, the PCB will be damaged.)
 - 2-2 Check the thermistor sensor, drain pump/hose, and display are connected correctly.
-
- 3 Press K1 on the outdoor unit PCB.
-



Troubleshooting

Outdoor unit

If an error occurs during the operation, it is displayed on the outdoor unit PCB.

No.	LED Display			Meaning
	Red	Green	Yellow	
-	☉	○	○	IPM Over Current(O.C)
4	○	☉	○	Comp starting error
6	○	●	○	Comp lock error
7	☉	●	○	DC-Link voltage under/over error
8	☉	○	☉	Outdoor temp sensor error
9	●	○	☉	Discharge over temperature
10	○	☉	☉	Discharge temp sensor error
11	●	☉	☉	Current sensor error
12	○	●	☉	Comp Vlimit error
13	☉	●	☉	Coil temp sensor error
14	●	●	☉	1min. time out Comm.
15	○	○	●	Fan error
16	☉	○	●	OTP error
17	●	○	●	Comp rotation error
18	○	☉	●	Operation condition secession
19	☉	☉	●	DC-Link voltage sensor error
20	●	☉	●	I_Trip error/PFC Over current
21	○	●	●	GAS Leak error
22	☉	●	●	AC Line Zero Cross Signal out
24	○	○	☉	Capacity miss match





○ Off ☉ Blink ● On

Parts list

Receiver & Display Unit Accessories

Concealed type

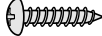
◆ Receiver & display unit





Receiver & display unit	STS 2S-2x10 tapped screw	2S-4x12 tapped screw	Owner's instructions	Installation manual
1	4	2	1	1
				

◆ Wire kit

Wire kit
1

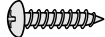
Standard type







◆ Receiver & display unit

Receiver & display unit	M4x16 tapped screw	Cable-tie	Cable clamp	Owner's instructions	Installation manual
1	7	2	5	1	1
					





◆ Wire kit

Wire kit
1

Wireless Remote Controller Accessories

Wireless remote controller	Battery	Remote control holder	STS 2S-2x10 tapped screw	Owner's instructions	Installation manual
1	2	1	2	1	1
					

Wired Remote Controller Accessories

Wired remote controller	Cable-tie	Cable clamp	M4x16 tapped screw	Indoor unit power drawing cable
1	2	5	7	1
				
	Communication cable of the wired remote controller	Wire joint	Owner's instructions	Installation manual
	1	1	1	1
	