

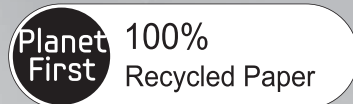

Cassette Type Series
4 Way Cassette

Air Conditioner user & installation manual



This manual is made with 100% recycled paper.

imagine the possibilities

Thank you for purchasing this Samsung product.

EN ES FR PT DB68-05137A-00



Features of your new air conditioner

Cool Summer Offer

On those hot sweltering summer days and long restless nights, there is no better escape from the heat than the cool comforts of home. Your new air conditioner brings an end to exhausting hot summer days and lets you rest. This summer, beat the heat with your own air conditioner.

Cost Efficient System

Your new air conditioner not only provides maximum cooling power in the summer, but can also be an efficient heating method in the winter with the advanced "Heat pump" system. This technology is up to 300% more efficient than electrical heating, so you can further reduce its running cost. Now, meet year-round needs with one air conditioner.

A Look for Everywhere

The elegant and harmonious design gives priority to the esthetics of your space and complements any of your existing interior décor. With its soft color and rounded-edge shape, the new air conditioner adds class to any room. Enjoy what your air conditioner offers both functionally and esthetically.

Compact and easy-to-use Cassette type

Designed to be installed into most types of suspended ceiling, the cassette type air conditioner is ideal for business and commercial accommodations. Fresh cool/warm air can be provided through the controllable 4 sides of the unit. All functions of the air conditioner will be controlled easily via a remote control.

Contents

User manual

Safety precautions	4
Viewing the parts	17
Using your air conditioner	18
Cleaning and maintaining the air conditioner	20
Appendix.....	24

Installation manual

Safety precautions	28
Accessories	30
Selecting the installation location	30
Deciding on where to install the indoor unit	32
Indoor unit installation	33
Purging the unit	34
Connecting the refrigerant pipe	35
Cutting/flaring the pipes	36
Performing leak test & insulation	37
Drainpipe and drain hose installation	39
Bushing bracket installation	42
Wiring work	43
Connecting the connection cord	44
Setting an indoor unit address and installation option	45
Troubleshooting	52











ENGLISH

Safety precautions

Before using your new air conditioner, please read this manual thoroughly to ensure that you know how to safely and efficiently operate the extensive features and functions of your new appliance.

Because the following operating instructions cover various models, the characteristics of your air conditioner may differ slightly from those described in this manual. If you have any questions, call your nearest contact center or find help and information online at www.samsung.com.

What the icons and signs in this user manual mean:

 WARNING	Risk of death or serious personal injury.
 CAUTION	Potential risk of personal injury or material damage.
 CAUTION	To reduce the risk of fire, explosion, electric shock, or personal injury when using your air conditioner, follow these basic safety instructions:
	Do NOT attempt.
	Do NOT disassemble.
	Do NOT touch.
	Follow directions carefully.
	Unplug the power plug from the wall socket.
	Make sure the machine is grounded to prevent electric shock.
	Call the contact center for help.

These warning signs are here to prevent injury to you and others.

Please follow them carefully.

After reading this section, keep it in a safe place for future reference.



SEVERE WARNING SIGNS



Do not place the air conditioner near hazardous substances or equipment that releases free flames to avoid fire, explosions or injuries.

- ▶ Potential risk of fire hazard or explosion.

Do not block or place items in front of the air conditioner. Do not step, hang onto, or place heavy items on the air conditioner.

- ▶ Potential risk of personal injury.

Do not install the outdoor unit at an unstable place or elevated surface where there is potential risk of falling.

- ▶ If the outdoor unit falls, it may cause personal injury or loss or property.

Any changes or modifications performed not following by the installation manual, failure or damage may occur on the condition.

In this case, user will be responsible for all the repair expenses.

If any gas or impurities other than R-410A refrigerant come into the refrigerant pipe, serious problem may occur and it may cause injury.

Do not spray flammable gases such as insecticide near the air conditioner.

- ▶ Potential risk of electric shock, fire or unit malfunction.

Do not insert anything such as fingers or branches into the air conditioner vents.

- ▶ Keep children away from the air conditioner. Potential risk of personal injury.

Do not cut the power plug and connect to a different power cable.

Never attempt to lengthen the power cable.

- ▶ Potential risk of fire or electric shock.

Safety precautions



SEVERE WARNING SIGNS



Do not yank the power cable and touch the power plug with hands.

- ▶ Potential risk of fire or electric shock.

Never use a damaged power plug, power cable, or loosened power receptacle.

- ▶ Potential risk of fire or electric shock.

The electric work must be done by qualified service technician in accordance with the national wiring regulations with rated cables.

- ▶ If the capacity of the power cable is insufficient or electric work have not done properly, electric shock or fire may occur.

You should connect the power cable into the power cable terminal and fasten it with a clamp.



Do not connect the air conditioner with heating apparatus or attempt to disassemble, remodel or repair it by yourself.

- ▶ Potential risk of malfunction, electric shock or fire. If repairs are needed, consult the contact center.

Consult the place of purchase or a contact center to disassemble or reinstall the air conditioner.

- ▶ Potential risk of unit malfunction, water leakage, electric shock, or fire.



Consult the place of purchase or contact center to install the air conditioner.

- ▶ Improper installation carries a risk of unit malfunction, water leakage, electric shock or fire.
- ▶ If installing in specialty areas, such as a factory complex or saline coastal area, consult the place of purchase or contact center for specific installation details.

Install the air conditioner with the support bracket securely fastened to use for an extended period of time.

- ▶ If the air conditioner falls, it may cause personal injury or loss of property.

If the indoor unit gets wet, turn the power off immediately and call your nearest contact center.

- ▶ Potential risk of fire or electric shock.

Install an exclusive circuit breaker and short-circuit breaker for the air conditioner.

- ▶ Potential risk of electric shock or fire.

If the power cable is damaged, the manufacturer or a qualified service technician must replace it.

Always make sure that the power supply is compliant with current safety standards. Always install the air conditioner in compliance with current local safety standards.

Verify that the voltage and frequency of the power supply comply with the specifications and that the installed power is sufficient to ensure the operation of any other domestic appliance connected to the same electric lines.

The air conditioner must be installed in accordance with national wiring regulations and safety regulations wherever applicable.

Install the supplied cables firmly. Fix them securely so that external force is not exerted to the terminal block.

- ▶ If the connection is loose, heat may generate and cause electric shock or fire.

Use a rated circuit breaker only.

- ▶ Never use steel wires or copper wires as a circuit breaker. It may cause fire or unit malfunction.

Safety precautions



SEVERE WARNING SIGNS



Use an exclusive power source for the air conditioner.

▶ Potential risk of electric shock or fire.

Do not put undue stress or place heavy object on the power cable.

Do not bend the power cable excessively.

▶ Potential risk of fire or electric shock.

Always verify that electric connections (cable entry, section of leads, protections...) are compliant with the electric specifications and with the instructions provided in the wiring scheme.

Always verify that all connections comply with the standards applicable to the installation of air conditioners.



Use a receptacle that has a ground terminal. The receptacle must be used exclusively for the air conditioner.

▶ Improper electrical grounding may cause electric shock or fire.

Be sure to ground the unit. Do not connect the ground wire to gas or water pipes, lighting rods, or telephone grounding lines.

▶ If the unit is not properly grounded, electric shock may result.

Always verify that a suitable grounding connection is available.



Disconnect the air conditioner from power supply before it is repaired or disassembled.



CAUTION SIGNS



Connect the refrigerant tubes first then the electrical lines, when installing the unit.

Always disassemble the electric lines before the refrigerant tubes. Verify that the air conditioner is connected to the power supply in accordance with the instructions provided in the wiring diagram included in the manual.

The manufacturer shall not be responsible for damage originating from unauthorized changes or the improper connection of electric and hydraulic lines.

Failure to comply with these instructions or to comply with the requirements set forth in the "Operating limits" table, included in the manual, and shall immediately invalidate the warranty.

Ensure no water gets into the air conditioner.

▶ **Potential risk or electric shock.**

Turn off the air conditioner using the provided remote control or control accessory (if provided). Do not unplug to turn off the unit (unless there is an immediate danger).

Do not open the front grille during operation.

▶ **Potential risk of electric shock or unit malfunction.**

Cool air should not flow directly towards people, pets, and plants.

▶ **It is harmful to your health, pets, and plants.**

Do not run the air conditioner for an extended period of time in a room with the door closed or with babies, elderly or disabled people.

▶ **Open the door or windows to ventilate your room at least once an hour to prevent oxygen shortage.**

Safety precautions



CAUTION SIGNS



Do not drink drain water coming out of the air conditioner.

▶ Potential risk of health hazard.

Do not expose the dust filter to direct sunlight while drying.

▶ Strong direct sunlight may deform the dust filter.

Do not allow children to climb on the air conditioner.

Use only rated accessories and install the air conditioner with rated equipment.

▶ If you do not use the rated accessories, the air conditioner may drop from its place, water may leak or electric shock or fire may occur.

Do not use the air conditioner as a cooling precision instrument for food, pets, plants, cosmetics or machinery.

Do not give excessive shock to the air conditioner.

▶ Potential risk of fire or unit malfunction.

Do not spray water directly on the air conditioner or use benzene, thinner or alcohol to clean the surface of the unit.

▶ Potential risk of electric shock or fire.

▶ Potential risk of damage to the air conditioner.

Do not place any objects, especially containers with liquid.



Do not touch the pipe connected to the air conditioner.



This appliance should be installed according to the provided installation manual.

Install the shortest possible length of pipe.

▶ If the length of pipe gets unnecessarily long, the life of air conditioner can be shorten and become inefficient.

Install the power cable and communication cable of the indoor and outdoor unit at least 1m away from the electric appliance.

Install the indoor unit away from lighting apparatus using the ballast.

- ▶ If you use the wireless remote control, reception error may occur due to the ballast of the lighting apparatus.

For maximum safety, installers should always carefully read the following warnings.

Do not install the air conditioner in following places.

- ▶ Place where there is mineral oil or arsenic acid.
- ▶ Resin parts flame and the accessories may drop or water may leak. The capacity of the heat exchanger may reduce or the air conditioner may be out of order.
- ▶ The place where corrosive gas such as sulfurous acid gas generates from the vent pipe or air outlet.
- ▶ The copper pipe or connection pipe may corrode and refrigerant may leak.
- ▶ The place where there is a machine that generates electromagnetic waves. The air conditioner may not operate normally due to control system.
- ▶ The place where there is a danger of existing combustible gas, carbon fiber or flammable dust.
- ▶ The place where thinners or gasoline are handled. Gas may leak and it may cause fire.

If the air conditioner is installed in a small room, measures must be taken to prevent the refrigerant concentration in the room from exceeding the safety limit in the event of refrigerant leakage. Consult a dealer regarding the appropriate measures to prevent the allowable concentration from being exceeded.

- ▶ If the refrigerant leaks, and cause the concentration limit to be exceeded, hazards due to lack of oxygen in the room may result.

Safety precautions



CAUTION SIGNS



Install the air conditioner away from direct exposure to sunlight, heating apparatus, and humid places.

- ▶ Hang curtains on windows to boost cooling efficiency and to avoid the risk of electric shock.

The air conditioner is composed of moving parts. Keep children away from the unit to avoid physical injury.

Check for damage on delivery. If damaged, do not install the air conditioner and call the place of purchase immediately.

Insert the dust filter before operating the air conditioner.

- ▶ If there is no dust filter inside the air conditioner, accumulated dust may shorten the life of the air conditioner and cause electricity waste.

Keep indoor temperatures stable and not extremely cold, especially where there are children, elderly or disabled people.

Clean the dust filter every 2 weeks. Clean the filter more frequently if the air conditioner is operated in dusty areas.

The packaging material and used batteries of the remote controller (optional) must be disposed of in accordance with the national standards.

The refrigerant used in the air conditioner must be treated as chemical waste. Dispose the refrigerant following national standards.

Have a qualified service technician install the air conditioner and perform a trial operation.

Firmly connect the drain hose to the air conditioner for proper water drainage.

Install the outdoor unit where operating noise and vibration will not disturb your neighbor and in a well-ventilated area with no obstacle.

- ▶ Potential risk of malfunction.
- ▶ Operating noise may disturb your neighbor.

Make sure that children take precautions against access to the air conditioner and they do not play with the unit.

When using a wireless remote control, the distance should not be more than 7 m (23 ft) from the air conditioner.

If the remote control is not used for a long period of time, remove the batteries to prevent leakage of electrolyte.

When cleaning the outdoor unit, touch the heat exchanger radiator fins with extreme care.

- ▶ Wearing thick gloves can protect your hands.

Make sure that the condensed water dripping from the drain hose runs out properly and safely.

Store the operation and installation manual in a safe location and remember to hand it over to the new owner if the air conditioner is sold or transferred.

All the materials used for the manufacture and packaging of the air conditioner are recyclable.

After completing the installation, always carry out a functional test and provide the instructions on how to operate the air conditioner to the user.

The appliance is not intended for use by young children or infirm persons without supervision: Young children should be supervised to ensure that they do not play with the appliance.

Clean the air conditioner after the inner fan stops operating.

- ▶ Potential risk of injury or electric shock.

Safety precautions



CAUTION SIGNS



Inspect the condition, electric connections, pipes and external case of the air conditioner regularly by a qualified service technician.

Do not open doors and windows in the room being cooled during operation unless necessary.

Do not block the air conditioner vents. If objects block the air flow, it may cause unit malfunction or poor performance.

Make sure there are no obstacles under the indoor unit.

▶ **Potential risk of fire or loss of property.**

Make sure that there are no obstacles or covers that block the air conditioner. Allow sufficient space for air circulation.

▶ **Insufficient ventilation may result in poor performance.**

This appliance is not intended for use by persons (including children) with reduced physical, sensory or mental capabilities, or lack of experience and knowledge, unless they have been given supervision or instruction concerning use of the appliance by a person responsible for their safety. Children should be supervised to ensure that they do not play with the appliance.

Make sure the voltage and frequency of the electric system are compatible with the air conditioner.

If a power outage occurs while the air conditioner is working, turn off the power source immediately.

Max current is measured according to IEC standard for safety and current is measured according to ISO standard for energy efficiency.

The unit must be plugged into an independent circuit if applicable or connect the power cable to the auxiliary circuit breaker. An all pole disconnection from the power supply must be incorporated in the fixed wiring with a contact opening of >3 mm (0.12 inch).

After connecting the power cable between the indoor/outdoor unit, attach the cover of component box securely and make sure it is not loose.

For the power cable, use the grade of H07RN-F or H05RN-F materials. The unbalanced power must be maintained within 10% of supply rating among whole indoor units.

If the power is unbalanced greatly, it may shorten the life of the condenser. If the unbalanced power is exceeded over 10% of supply rating, the indoor unit is protected, stopped and the error mode indicates.

To protect the product from water and possible shock, you should keep the power cable and the connection cord of the indoor and outdoor units in the protection tube.

Connect the power cable to the auxiliary circuit breaker.

You must keep the cable in a protection tube.

Keep distances of 50 mm (2 inch) or more between power cable and communication cable.

Maximum length of power cable is decided within 10% of power drop. If it exceeds, you must consider another power supplying method.

The circuit breaker (MCCB, ELB) should be considered more capacity, if many indoor units are connected from one breaker.

Use solderless ring terminal to connect the power cable to the power terminal block.

Use an appropriate screwdriver for tightening the terminal screws.





Over-tightening the terminal screws may break them.

The air conditioner should be used only for the applications for which it has been designed: the indoor unit is not suitable to be installed in areas used for laundry.

Safety precautions



CAUTION SIGNS

-  Our units must be installed in compliance with the spaces indicated in the installation manual to ensure either accessibility from both sides or ability to perform routine maintenance and repairs. The units' components must be accessible and that can be disassembled in conditions of complete safety either for people or things. For this reason, where it is not observed as indicated into the Installation Manual, the cost necessary to reach and repair the unit (in safety, as required by current regulations in force) with slings, trucks, scaffolding or any other means of elevation won't be considered in-warranty and charged to end user.
-  Ensure the off-on and protection switches are properly installed.
Do not use the air conditioner if damaged. If problems occur, immediately stop operation and disconnect the plug from the power supply.
If the air conditioner will not be used for an extended period of time (for example, over several months), unplug the power from the wall.
-  Call the place of purchase or a contact center if repairs are needed.
 - ▶ Potential risk of fire or electric shock if disassembly or repairs are attempted by a non-qualified service technician.
If you smell burning plastic, hear strange sounds, or see smoke coming from the unit, unplug the air conditioner immediately and call a contact center.
 - ▶ Potential risk of fire or electric shock.
-  **State of California Proposition 65 Warning (US only)**
 This product contains chemicals known to the State of California to cause cancer and reproductive toxicity.

Viewing the parts

Main parts

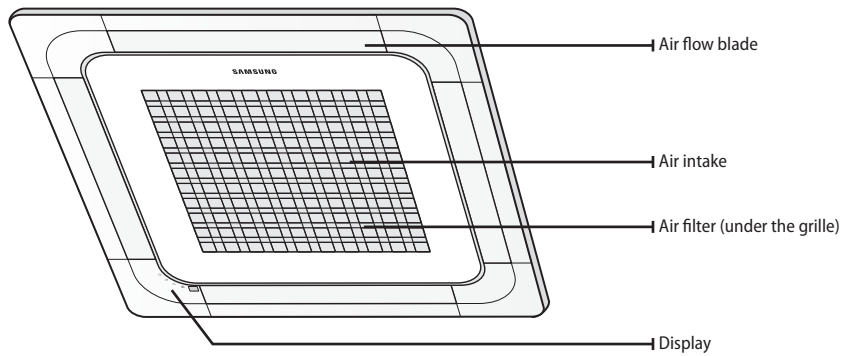

Indicator

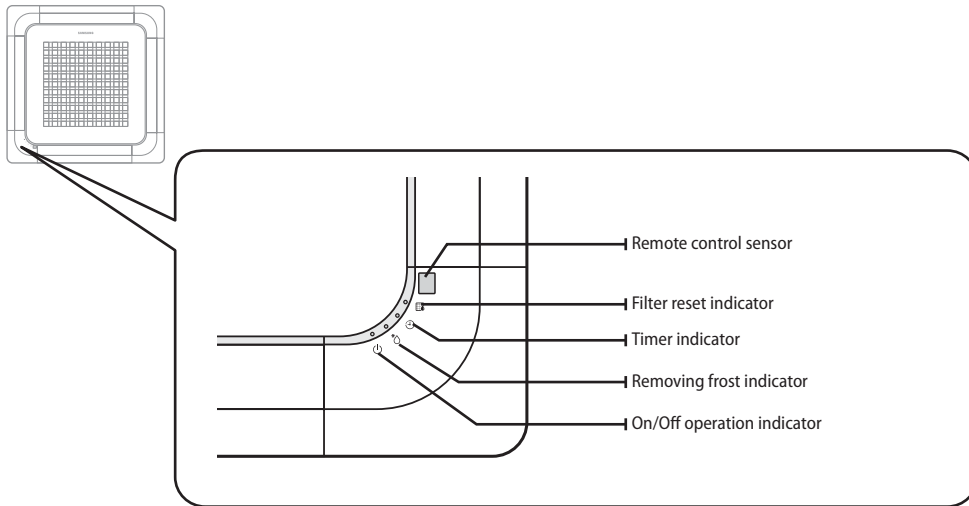

NOTE • Your air conditioner and display may look slightly different from the illustration shown above depending on your model.

Using your air conditioner

Tips on using air conditioner

Here are some tips that you would follow when using your air conditioner.

TOPIC	RECOMMENDATION
Cooling	<ul style="list-style-type: none">• If current outside temperatures are much higher than the selected indoor temperature, it may take time to bring the inner temperature to the desired coolness.• Avoid drastically turning down the temperature. Energy is wasted and the room does not cool faster.
Heating	<ul style="list-style-type: none">• Since the air conditioner heats the room by taking heat energy from outdoor air, the heating capacity may decrease when outdoor temperatures are extremely low. If you feel the air conditioner insufficiently heats, using an additional heating appliance in combination with the air conditioner is recommended.
Frost & De-ice	<ul style="list-style-type: none">• When the air conditioner runs in Heat mode, due to temperature difference between the unit and the outside air, frost will form. If this happens:<ul style="list-style-type: none">- The air conditioner stops heating.- The air conditioner will operate automatically in De-ice mode for 10 minutes.- The steam produced on the outdoor unit in De-ice mode is safe.

TOPIC	RECOMMENDATION
Frost & De-ice	<p>No intervention is required; after about 10 minutes, the air conditioner operates again normally.</p> <div style="border: 1px solid black; padding: 5px; margin-top: 10px;">  <ul style="list-style-type: none"> • The unit will not operate when it starts to de-ice. </div>
Fan	<ul style="list-style-type: none"> • Fan may not operate for about 3~5 minutes at the beginning to prevent any cold blasts while the air conditioner is warming up.
High indoor/ outdoor temperatures	<ul style="list-style-type: none"> • If both indoor and outdoor temperatures are high and the air conditioner is running in Heat mode, the outdoor unit's fan and compressor may stop at times. This is normal; wait until the air conditioner turns on again.
Power failure	<ul style="list-style-type: none"> • If a power failure occurs during the operation of the air conditioner, the operating immediately stops and unit will be off. When power returns, the air conditioner will run automatically.
Protection mechanism	<ul style="list-style-type: none"> • If the air conditioner has just been turned on after operation stops or being plugged in, cool/warm air does not come out for 3 minutes to protect the compressor of the outdoor unit.

Cleaning and maintaining the air conditioner

For the best performance of your air conditioner, clean it periodically. When cleaning, make sure to unplug the unit for user's safety.

Cleaning the exterior

Wipe the surface of the unit with a slightly wet or dry cloth when needed.
Wipe off dirt of odd-shaped area by using a soft brush.



- Do not use Benzene or Thinner. They may damage the surface of the air conditioner and can create a risk of fire.

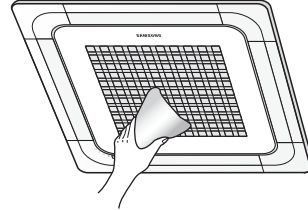

Cleaning air filter and grille

When cleaning air filter and grille, make sure to unplug the unit. No special tools are needed to clean it.

1. Open the front grille.
 - Open the blades on the left and right side of the Samsung logo. Press both of the levers and pull the grille downward. Two safety clips are mounted to the front grille to prevent it from dropping.
2. Detach the front grille.
 - Remove the safety clip first and then remove the hinge. Pull the green switch on the hinge part down and then press and pull the hinge part to remove the grille. (There are two hinges on the grille and you must apply this step on both of them to remove the grille.)

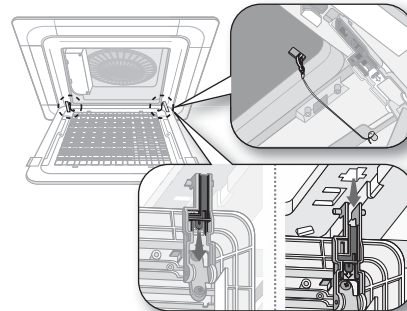
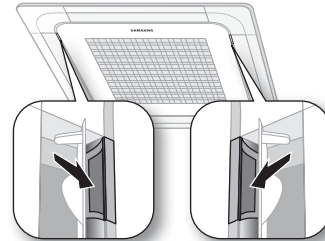

- If you want to clean the filter only, you do not have to detach the grille. Follow step 4 and 5

3. Pull out the Air filter.

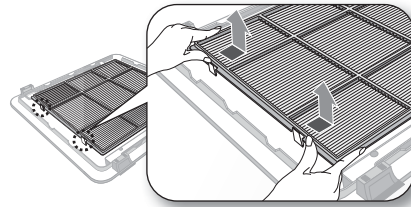

4. Clean the grille and Air filter with a vacuum cleaner or soft brush. If dust is too heavy, then rinse it with running water and dry it in a ventilated area.

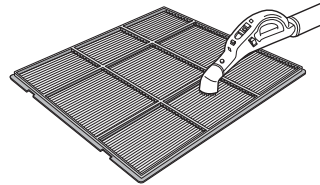

NOTE

- For best conditions, repeat every two weeks.
- If the Air filter dries in a confined (or humid) area, odors may generate. If it occurs, re-clean and dry it in a well-ventilated area.

5. Insert the Air filter back in its original position.
 - You will hear a click sound when the Air filter is properly placed.
6. Attach the front grille.
 - Reverse the above steps to attach the front grille.



NOTE

- The illustration shown above may differ from yours depending on your model.
- After cleaning the filter, press the **Filter Reset** button on the remote control for 2 seconds to reset the filter schedule. Filter sign indicator will be on for cleaning time.
- If the angle on the air flow blades has been changed by user due to opening the front grille for installation or maintenance, you must turn off the circuit breaker and turn it on again before using the air conditioner. Otherwise, angles of the each angle can be different or some of the blade may not close when the product is off.

Cleaning and maintaining the air conditioner

Maintaining your air conditioner

If the air conditioner will not be used for an extended period of time, dry the air conditioner to maintain it in best condition.

1. Dry the air conditioner thoroughly by operating in Fan mode for 3 to 4 hours and disconnect the power plug. There may be internal damage if moisture is left in components.
2. Before using the air conditioner again, dry the inner components of the air conditioner again by running in Fan mode for 3 to 4 hours. This helps remove odors which may have generated from dampness.

Periodical checks

Refer to the following chart to maintain the air conditioner properly.

Type	Description	Monthly	Every 4 months	Once a year
Indoor unit	Clean the air filter (1)	●		
	Clean the condensate drain pan (2)			●
	Thoroughly clean the heat exchanger (2)			●
	Clean the condensate drain pipe (2)		●	
	Replace the remote control batteries (1)			●
Outdoor unit	Clean the heat exchanger on the outside of the unit (2)		●	
	Clean the heat exchanger on the inside of the unit (2)			●
	Clean the electric components with jets of air (2)			●
	Verify that all the electric components are firmly tightened (2)			●
	Clean the fan (2)			●
	Verify that all the fan assembly is firmly tightened (2)			●
	Clean the condensate drain pan (2)			●



NOTE

- The checks and maintenance operations described are essential to guarantee the efficiency of the air conditioner. The frequency of these operations varies according to the characteristics of the area, the amount of dust, etc.
- The described operations should be performed more frequently if the area of installation is very dusty.



CAUTION

- These operations must always be performed by qualified personnel. For more detailed information, see the Installation Manual.

Internal protections via the unit control system

This internal protection operates if an internal fault occurs in the air conditioner.

Type	Description
Against cold air	The internal fan will be off to against cold air when the heat pump is heating.
De-ice cycle	The internal fan will be off to against cold air when the heat pump is heating.
Anti-protection of internal battery	The compressor will be off to protect internal battery when the air conditioner operates in Cool mode.
Protect compressor	The air conditioner does not start operating immediately to protect the compressor of the outdoor unit after it has been started.



NOTE

- If the heat pump is operating in Heat mode, De-ice cycle is actuated to remove frost from an outdoor unit that may have deposited at low temperatures.
- The internal fan is switched off automatically and restarted only after the de-ice cycle is completed.

Appendix

Troubleshooting

Refer to the following chart if the air conditioner operates abnormally. This may save time and unnecessary expenses.

PROBLEM	SOLUTION
The air conditioner does not operate immediately after it has been restarted.	<ul style="list-style-type: none">• Because of the protective mechanism, the appliance does not start operating immediately to keep the unit from overloading. The air conditioner will start in 3 minutes.
The air conditioner does not work at all.	<ul style="list-style-type: none">• Check that the power plug is properly connected. Insert the power plug into the wall socket correctly.• Check if the circuit breaker is switched off.• Check if there is a power failure.• Check your fuse. Make sure it is not blown out.
The temperature does not change.	<ul style="list-style-type: none">• Check if you selected Fan mode. Press the Mode button on the remote control to select another mode.
The cool (warm) air does not come out of the air conditioner.	<ul style="list-style-type: none">• Check if the set temperature is higher (lower) than the current temperature. Press the Temperature button on the remote control to change the set temperature. Press the Temperature button to decrease or increase the temperature.• Check if the air filter is blocked by dirt. Clean the air filter every two weeks.

PROBLEM	SOLUTION
<p>The cool (warm) air does not come out of the air conditioner.</p>	<ul style="list-style-type: none"> • Check if the air conditioner has just been turned on. If so, wait 3 minutes. Cool (warm) air does not come out to protect the compressor of the outdoor unit. • Check if the air conditioner is installed in a place with a direct exposure to sunlight. Hang curtains on windows to boost cooling efficiency. • Check if the cover or any obstacle is not near the outdoor unit. • Check if the refrigerant pipe is too long. • Check if the air conditioner is only available in Cool mode. • Check if the remote control is only available for cooling model.
<p>The fan speed does not change.</p>	<ul style="list-style-type: none"> • Check if you selected Auto or Dry mode. The air conditioner automatically adjusts the fan speed to Auto in Auto/Dry mode.
<p>Timer function does not set.</p>	<ul style="list-style-type: none"> • Check if you press the Power button on the remote control after you have set the time.
<p>Odors permeate in the room during operation.</p>	<ul style="list-style-type: none"> • Check if the appliance is running in a smoky area or if there is a smell entering from outside. Operate the air conditioner in Fan mode or open the windows to air out the room.

Appendix

PROBLEM	SOLUTION
The air conditioner makes a bubbling sound.	<ul style="list-style-type: none"> • A bubbling sound may be heard when the refrigerant is circulating through the compressor. Let the air conditioner operate in a selected mode. • When you press the Power button on the remote control, noise may be heard from the drain pump inside the air conditioner.
Water is dripping from the air flow blades.	<ul style="list-style-type: none"> • Check if the air conditioner has been cooling for an extended period of time with the air flow blades pointed downwards. Condensation may generate due to the difference in temperature.
Remote control is not working.	<ul style="list-style-type: none"> • Check if your batteries are depleted. • Make sure batteries are correctly installed. • Make sure nothing is blocking your remote control sensor. • Check that there are strong lighting apparatus near the air conditioner. Strong light which comes from fluorescent bulbs or neon signs may interrupt the electric waves.
The air conditioner does not turn on or off with the wired remote control.	<ul style="list-style-type: none"> • Check if you set the wired remote control for group control.
The wired remote control does not operate.	<ul style="list-style-type: none"> • Check if TEST indicator is displayed on the wired remote control. If so, turn off the unit and switch off the circuit breaker. Call your nearest contact center.

PROBLEM	SOLUTION
The indicators of the digital display flashes.	<ul style="list-style-type: none"> • Press the Power button on the remote control to turn the unit off and switch the circuit breaker off. Then, switch it on again.

Operation ranges

The table below indicates the temperature and humidity ranges the air conditioner can be operated within. Refer to the table for efficient use.

MODE	Indoor temperature	Outdoor temperature	Indoor humidity
Cooling	18°C to 32°C (64°F to 90°F)	-5°C to 48°C (23°F to 118°F)	80% or less
Heating	27°C(81°F) or less	-20°C to 24°C (-4°F to 75°F)	-
Drying	18°C to 32°C (64°F to 90°F)	-5°C to 48°C (23°F to 118°F)	-

Safety precautions

Carefully follow the precautions listed below because they are essential to guarantee the safety of the equipment.



WARNING

- Always disconnect the air conditioner from the power supply before servicing it or accessing its internal components.
- Verify that installation and testing operations are performed by qualified personnel.
- Verify that the air conditioner is not installed in an easily accessible area.

General information

- ▶ Carefully read the content of this manual before installing the air conditioner and store the manual in a safe place in order to be able to use it as reference after installation.
- ▶ For maximum safety, installers should always carefully read the following warnings.
- ▶ Store the operation and installation manual in a safe location and remember to hand it over to the new owner if the air conditioner is sold or transferred.
- ▶ This manual explains how to install an indoor unit with a split system with two SAMSUNG units. The use of other types of units with different control systems may damage the units and invalidate the warranty. The manufacturer shall not be responsible for damages arising from the use of non compliant units.
- ▶ The manufacturer shall not be responsible for damage originating from unauthorized changes or the improper connection of electric and hydraulic lines. Failure to comply with these instructions or to comply with the requirements set forth in the "Operating limits" table, included in the manual, shall immediately invalidate the warranty.
- ▶ The air conditioner should be used only for the applications for which it has been designed: the indoor unit is not suitable to be installed in areas used for laundry.
- ▶ Do not use the units if damaged. If problems occur, switch the unit off and disconnect it from the power supply.
- ▶ In order to prevent electric shocks, fires or injuries, always stop the unit, disable the protection switch and contact SAMSUNG's technical support if the unit produces smoke, if the power cable is hot or damaged or if the unit is very noisy.
- ▶ Always remember to inspect the unit, electric connections, refrigerant tubes and protections regularly. These operations should be performed by qualified personnel only.
- ▶ The unit contains moving parts, which should always be kept out of the reach of children.
- ▶ Do not attempt to repair, move, alter or reinstall the unit. If performed by unauthorized personnel, these operations may cause electric shocks or fires.
- ▶ Do not place containers with liquids or other objects on the unit.
- ▶ All the materials used for the manufacture and packaging of the air conditioner are recyclable.
- ▶ The packing material and exhaust batteries of the remote control(optional) must be disposed of in accordance with current laws.
- ▶ The air conditioner contains a refrigerant that has to be disposed of as special waste. At the end of its life cycle, the air conditioner must be disposed of in authorized centers or returned to the retailer so that it can be disposed of correctly and safely.

Installing the unit

IMPORTANT: When installing the unit, always remember to connect first the refrigerant tubes, then the electrical lines. Always disassemble the electric lines before the refrigerant tubes.

- ▶ Upon receipt, inspect the product to verify that it has not been damaged during transport. If the product appears damaged, DO NOT INSTALL it and immediately report the damage to the carrier or retailer (if the installer or the authorized technician has collected the material from the retailer.)
- ▶ After completing the installation, always carry out a functional test and provide the instructions on how to operate the air conditioner to the user.
- ▶ Do not use the air conditioner in environments with hazardous substances or close to equipment that release free flames to avoid the occurrence of fires, explosions or injuries.

- ▶ The air conditioner should be used only for the applications for which it has been designed: the indoor unit is not suitable to be installed in areas used for laundry.
- ▶ Our units must be installed in compliance with the spaces indicated in the installation manual to ensure either accessibility from both sides or ability to perform routine maintenance and repairs. The units' components must be accessible and that can be disassembled in conditions of complete safety either for people or things.
- ▶ This unit intended for free-air discharge or for connection to a duct connection supplying one room.
For this reason, where it is not observed as indicated into the Installation Manual, the cost necessary to reach and repair the unit (in safety, as required by current regulations in force) with slings, trucks, scaffolding or any other means of elevation won't be considered in-warranty and charged to end user.

Power supply line, fuse or circuit breaker

- ▶ Always make sure that the power supply is compliant with current safety standards. Always install the air conditioner in compliance with current local safety standards.
- ▶ Always verify that a suitable grounding connection is available.
- ▶ Verify that the voltage and frequency of the power supply comply with the specifications and that the installed power is sufficient to ensure the operation of any other domestic appliance connected to the same electric lines.
- ▶ Always verify that the cut-off and protection switches are suitably dimensioned.
- ▶ Verify that the air conditioner is connected to the power supply in accordance with the instructions provided in the wiring diagram included in the manual.
- ▶ Always verify that electric connections (cable entry, section of leads, protections...) are compliant with the electric specifications and with the instructions provided in the wiring scheme. Always verify that all connections comply with the standards applicable to the installation of air conditioners.
- ▶ This unit intended for free-air discharge or for connection to a duct connection supplying one room.









CAUTION

- Make sure that you earth the cables.
 - Do not connect the earth wire to the gas pipe, water pipe, lighting rod or telephone wire. If earthing is not complete, electric shock or fire may occur.
- Install the circuit breaker.
 - If the circuit breaker is not installed, electric shock or fire may occur.
- Make sure that the condensed water dripping from the drain hose runs out properly and safely.
- Install the power cable and communication cable of the indoor and outdoor unit at least 1m away from the electric appliance.
- Install the indoor unit away from lighting apparatus using the ballast.
 - If you use the wireless remote control, reception error may occur due to the ballast of the lighting apparatus.
- Do not install the air conditioner in following places.
 - Place where there is mineral oil or arsenic acid. Resin parts flame and the accessories may drop or water may leak. The capacity of the heat exchanger may reduce or the air conditioner may be out of order.
 - The place where corrosive gas such as sulfurous acid gas generates from the vent pipe or air outlet. The copper pipe or connection pipe may corrode and refrigerant may leak.
 - The place where there is a machine that generates electromagnetic waves. The air conditioner may not operate normally due to control system.
 - The place where there is a danger of existing combustible gas, carbon fiber or flammable dust. The place where thinner or gasoline is handled. Gas may leak and it may cause fire.

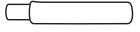
Accessories

The following accessories are supplied with the indoor unit.
The type and quantity may differ depending on the specifications.

Bushing bracket 	Insulation pipe 	Cable-tie 	Drain hose 
User manual 	Installation manual 	Clamp 	

Selecting the installation location

Indoor unit

- ▶ There must be no obstacles near the air inlet and outlet.
- ▶ Install the indoor unit on a ceiling that can support its weight.
- ▶ Maintain sufficient clearance around the indoor unit.
- ▶ Make sure that the water dripping from the drain hose runs away correctly and safely.
- ▶ The indoor unit must be installed in this way, that they are out of public access. (Not touchable by the users)
- ▶ Rigid wall without vibration.
- ▶ Where it is not exposed to direct sunshine.
- ▶ Where the air filter can be removed and cleaned easily.



- As a rule, the unit cannot be installed at a height of less than 2.5 m (8.2 ft).
- It is possible to install the unit at a height of between 2.2 ~2.5 m (7.2~8.2 ft) from the ground, if the unit has a duct with a well defined length [300 mm (11.8 inch) or more] to avoid fan motor blower contact.
- If you install the cassette or duct type indoor unit on the ceiling with humidity over 80%, you must apply extra 10 mm (0.39 inch) of polyethylene foam or other insulation with similar material on the body of the indoor unit.

Selecting the installation location

Space requirements for indoor unit

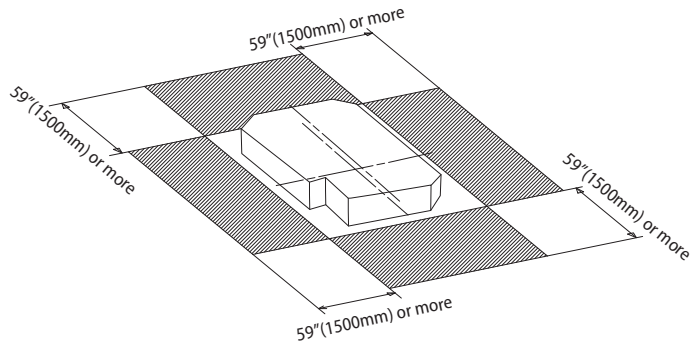

CAUTION

- The units must be installed according to distances declared, in order to permit accessibility from each side, either to guarantee correct operation of maintenance or repairing products. The unit's parts must be reachable and removable completely under safety condition (for people or things).

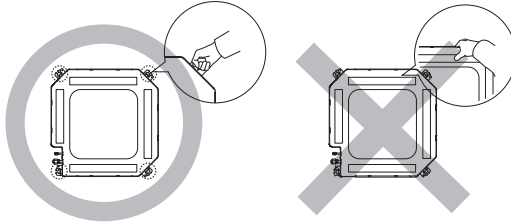

- Do not hold the discharge while carrying the indoor unit to avoid the possibility of breakage. You must hold the hanger plate on the corner and carry the indoor unit.

Deciding on where to install the indoor unit

Drawing of the indoor unit

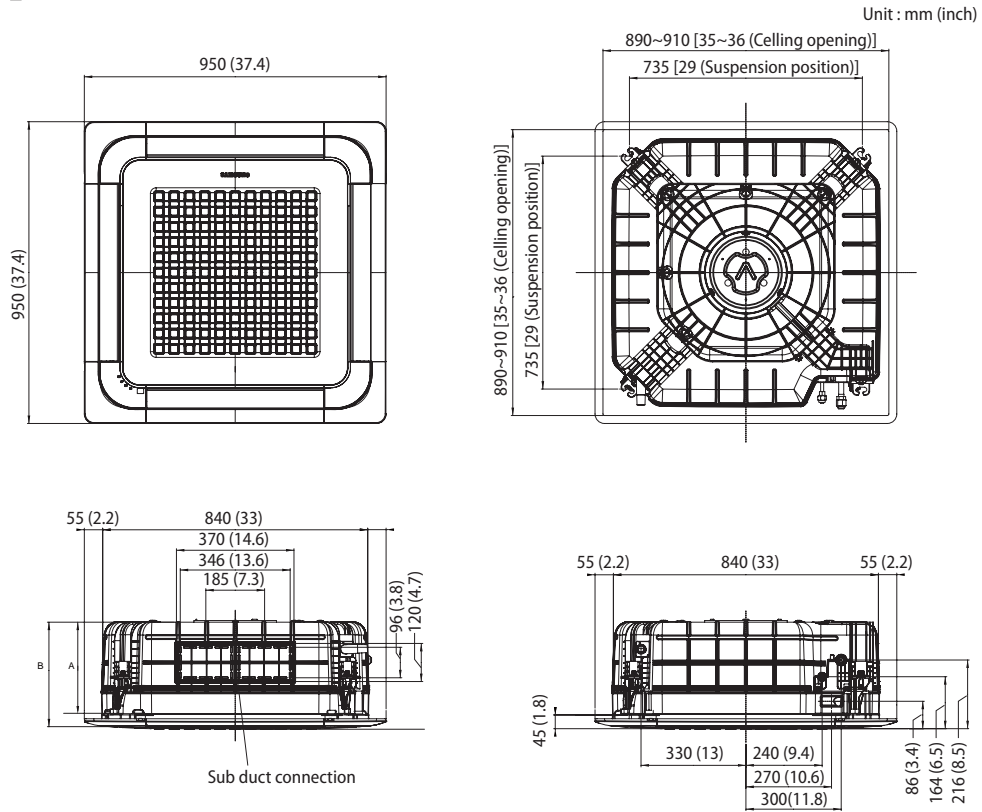

MODEL		*018*	*024*	*030*
				036
				042
				048
A	Inch (mm)	8 (204)		11.3 (288)
B		10 (253)		13.3 (337)
Net dimension		33×8×33 (840×204×840)		33×11.3×33 (840×288×840)
Liquid pipe connection		1/4" (6.35)	1/4" (6.35)	3/8" (9.52)
Gas pipe connection		1/2" (12.7)	5/8" (15.88)	5/8" (15.88)
Drain hose connection	OD : Ø1.25(32.0), ID : Ø1.04(26.5)			



• This unit intended for free-air discharge or for connection to a duct connection supplying one room.

Indoor unit installation

It is recommended to install the Y-joint before installing the indoor unit.

1. Place the pattern sheet on the ceiling at the spot where you want to install the indoor unit.



• Since the diagram is made of paper, it may shrink or stretch slightly due to temperature or humidity. For this reason, before drilling the holes maintain the correct dimensions between the markings.

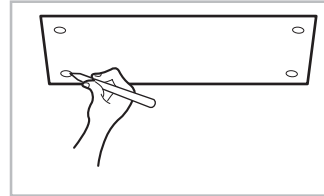

2. Insert bolt anchors, use existing ceiling supports or construct a suitable support as shown in figure.

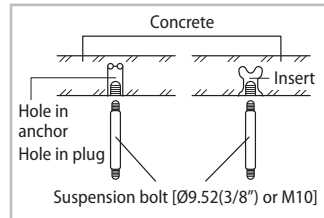

3. Install the suspension bolts depending on the ceiling type.



• Ensure that the ceiling is strong enough to support the weight of the indoor unit. Before hanging the unit, test the strength of each attached suspension bolt.

- If the length of suspension bolt is more than 1.5m (4.92 ft), it is required to prevent vibration.
- If this is not possible, create an opening on the false ceiling in order to be able to use it to perform the required operations on the indoor unit.

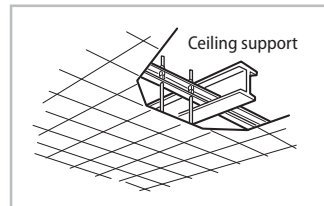

4. Screw eight nuts to the suspension bolts making space for hanging the indoor unit.



• You must install the suspension bolts more than four when installing the indoor unit.

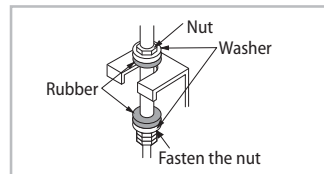

5. Check the level of the indoor unit by using a leveler.
- A tilt of the indoor unit may cause malfunction of a built-in float switch and water leaks.

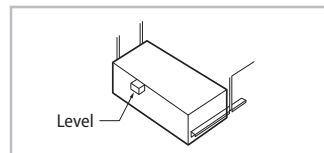

Indoor unit installation

- Adjust the height of the indoor unit by using the gauge of dimensions.
 - You should adjust the gauge of dimensions and the pattern sheet to fit the cutting dimensions of ceiling.
 - Make sure that the indoor unit is installed at a level if the indoor unit slants too much, there can be water leaks.

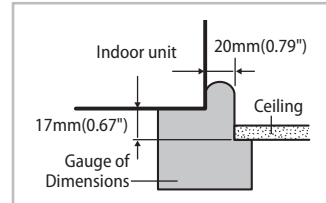

- Tighten the upper part nuts.
- Remove the gauge of dimensions after installing the indoor unit.

Purging the unit

From factory the unit is supplied and set with a pre-charge of nitrogen gas. (insert gas) Therefore, all insert gas must be purged before connecting the assembly piping.

Unscrew the pinch pipe at the end of each refrigerant pipe.

RESULT : All inert gas escapes from the indoor unit.



- To prevent dirt or foreign objects from getting into the pipes during installation, do NOT remove the pinch pipe completely until you are ready to connect the piping.

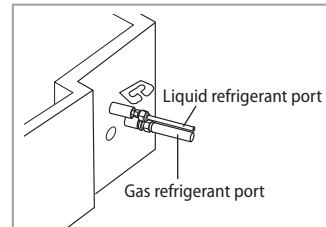

Connecting the refrigerant pipe

There are two refrigerant pipes of different diameters :

- ▶ A smaller one for the liquid refrigerant
- ▶ A larger one for the gas refrigerant
- ▶ The inside of copper pipe must be clean & has no dust

1. Remove the pinch pipe on the pipes and connect the assembly pipes to each pipe, tightening the nuts, first manually and then with a torque wrench, a spanner applying the following torque.

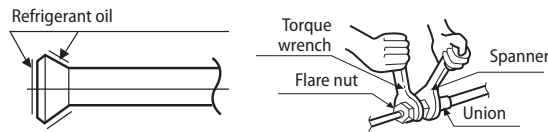

Outer Diameter		Torque	
mm	inch	N·m	lbf·ft
6.35	1/4	14~18	10.3~13.3
9.52	3/8	34~42	25.1~31.0
12.70	1/2	49~61	36.1~45.0
15.88	5/8	68~82	50.2~60.5



• If the pipes must be shortened refer to page 36.

2. Must use insulator which is thick enough to cover the refrigerant tube to protect the condensate water on the outside of pipe falling onto the floor and the efficiency of the unit will be better.

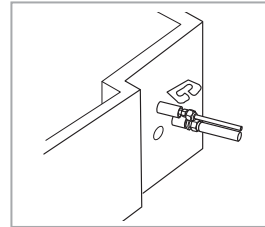

3. Cut off any excess foam insulation.
4. Be sure that there must be no crack or wave on the bended area.
5. It would be necessary to double the insulation thickness(10mm or more) to prevent condensation even on the insulator when if the installed area is warm and humid.
6. Do not use joints or extensions for the pipes that connect the indoor and outdoor unit. The only permitted connections are those for which the units are designed.



- Connect the indoor and outdoor units using pipes with flared connections(not supplied). For the lines, use insulated, unwelded, degreased and deoxidized copper pipe,(Cu DHP type to ISO 1337), suitable for operating pressures of at least 4200kPa(609.2 psi) and for a burst pressure of at least 20700kPa(3002.3 psi). Copper pipe for hydro-sanitary applications is completely unsuitable.
- For sizing and limits (height difference, line length, max. bends, refrigerant charge, etc.) see the outdoor unit installation manual.
- All refrigerant connection must be accessible, in order to permit either unit maintenance or removing it completely.

Cutting/flaring the pipes

1. Make sure that you prepared the required tools. (pipe cutter, reamer, flaring tool and pipe holder)
2. If you want to shorten the pipe, cut it using a pipe cutter ensuring that the cut edge remains at 90° with the side of the pipe. There are some examples of correctly and incorrectly cut edges below.

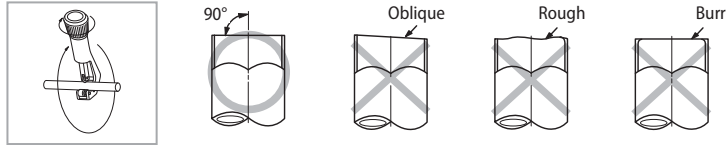

3. To prevent a gas leak, remove all burrs at the cut edge of the pipe using a reamer.
4. Carry out flaring work using flaring tool as shown below.

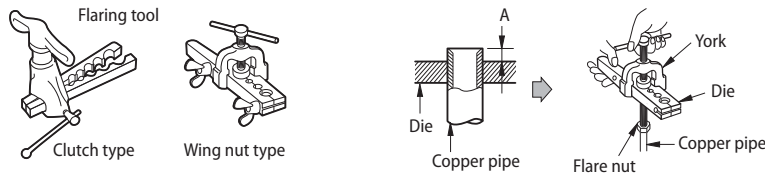

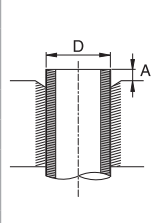
	Outer diameter (D)		Depth of flaring part (A)					
			Using flaring tool for R-410A		Using conventional flaring tool			
					Clutch type		Wing nut type	
mm	inch	mm	inch	mm	inch	mm	inch	
6.35	1/4	0~0.5	0~0.02	1.0~1.5	0.04~0.06	1.5~2.0	0.06~0.08	
9.52	3/8	0~0.5	0~0.02	1.0~1.5	0.04~0.06	1.5~2.0	0.06~0.08	
12.70	1/2	0~0.5	0~0.02	1.0~1.5	0.04~0.06	1.5~2.0	0.06~0.08	
15.88	5/8	0~0.5	0~0.02	1.0~1.5	0.04~0.06	1.5~2.0	0.06~0.08	

5. Check if you flared the pipe correctly. There are some examples of incorrectly flared pipes below.

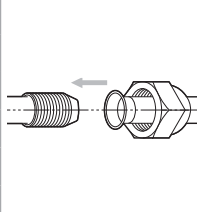
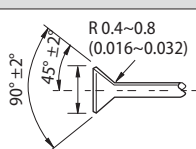

6. Align the pipes and tighten the flare nuts first manually and then with a torque wrench, applying the following torque.

	Outer diameter		Connection Torque		Flare dimension		Flare shape [mm(inch)]
	mm	inch	N·m	lbf·ft	mm	inch	
	6.35	1/4	14~18	10.3~13.3	8.7~9.1	0.34~0.36	
	9.52	3/8	34~42	25.1~31.0	12.8~13.2	0.50~0.52	
	12.70	1/2	49~61	36.1~45.0	16.2~16.6	0.64~0.65	
	15.88	5/8	68~82	50.2~60.5	19.3~19.7	0.76~0.78	



• In case of needing brazing, you must work with Nitrogen gas blowing.

Performing leak test & insulation

Leak test

LEAK TEST WITH NITROGEN (before opening valves)

In order to detect basic refrigerant leaks, before recreating the vacuum and recirculating the R-410A, it's responsible of installer to pressurize the whole system with nitrogen (using a pressure regulator) at a pressure above 4.1 MPa [594.7 psig (gauge)].

LEAK TEST WITH R-410A (after opening valves)

Before opening valves, discharge all the nitrogen into the system and create vacuum. After opening valves check leaks using a leak detector for refrigerant R-410A.

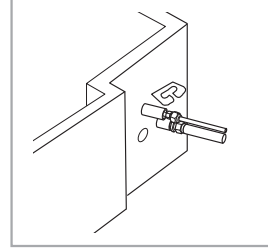

- Discharge all the nitrogen to create a vacuum and charge the system.

Insulation

Once you have checked that there are no leaks in the system, you can insulate the piping and hose.

1. To avoid condensation problems, place **T13.0 (1/2") or thicker Acrylonitrile Butadiene Rubber** separately around each refrigerant pipe.



- Always make the seam of pipes face upwards.

2. Wind insulating tape around the pipes and drain hose avoiding to compress the insulation too much.
3. Finish wrapping insulating tape around the rest of the pipes leading to the outdoor unit.
4. The pipes and electrical cables connecting the indoor unit with the outdoor unit must be fixed to the wall with suitable ducts.

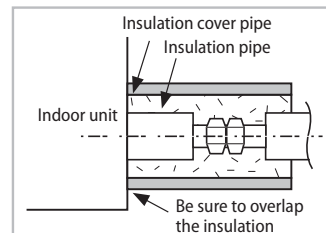
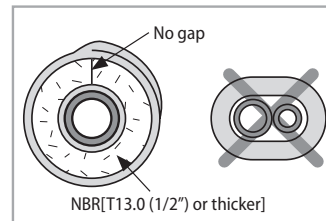

- Must fit tightly against body without any gap.



- All refrigerant connection must be accessible, in order to permit either unit maintenance or removing it completely.

Performing leak test & insulation

5. Select the insulation of the refrigerant pipe.

- ▶ Insulate the gas side and liquid side pipe referring to the thickness according to the pipe size.
- ▶ Indoor temperature of 30°C(86°F) and humidity of 85% is the standard condition. If installing in a high humidity condition, use one grade thicker insulator by referring to the table below. If installing in an unfavorable conditions, use thicker one.
- ▶ Insulator's heat-resistance temperature should be more than 120°C(248°F).

Pipe	Pipe size		Insulation Type (Heating/Cooling)				Remarks
			General [30°C(86°F), 85%]		High humidity [30°C(86°F), over 85%]		
			EPDM, NBR				
mm	inch	mm	inch	mm	inch		
Liquid pipe	6.35 ~ 9.52	1/4~3/8	9	3/8	9	3/8	Heating resisting temperature over 120°C(248°F)
	12.7 ~ 50.80	1/2~2	13	1/2	13	1/2	
Gas pipe	6.35	1/4	13	1/2	19	3/4	
	9.52 ~ 25.40	3/8~1	19	3/4	25	1	
	28.58 ~ 44.45	1 1/8~1 3/4	19	3/4	32	1 1/4	
	50.80	2	25	1	38	1 1/2	

- ▶ When installing insulation in places and conditions below, use the same insulation that is used for high humidity conditions.
 - <Geological condition>
 - High humidity places such as shoreline, hot spring, near lake or river, and ridge (when the part of the building is covered by earth and sand.)
 - <Operation purpose condition>
 - Restaurant ceiling, sauna, swimming pool etc.
 - <Building construction condition>
 - The ceiling frequently exposed to moisture and cooling is not covered.
e.g. The pipe installed at a corridor of a dormitory and studio or near an exit that opens and closes frequently.
 - The place where the pipe is installed is highly humid due to the lack of ventilation system.

Drainpipe and drain hose installation

Care must be taken when installing the drainpipe and drain hose for the indoor unit so that condensate water is drained correctly outside.

Fix the flexible hose to the drainpipe.

- ▶ Push the supplied drain hose as far as possible over the drain socket.
- ▶ Tighten the metal clamp as shown in the picture.
- ▶ Wrap the supplied large sealing pad over the metal clamp and drain hose to insulate and fix it with clamps.
- ▶ Insulate the complete drain piping inside the building (field supply). If the drain hose cannot be sufficiently set on a slope, fit the hose with drain raising piping (field supply).
- ▶ Push the drain hose up to insulation when connecting the drain hose to drain socket.

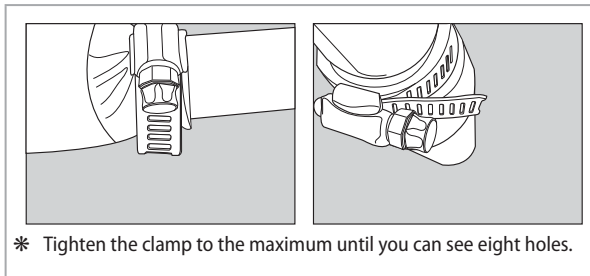
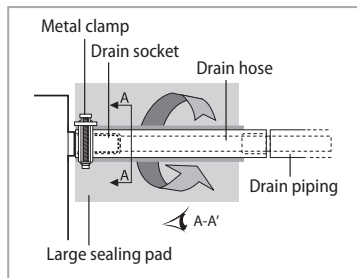

Drainpipe and drain hose installation

Drainpipe connection

1. The drain pipe should be installed within 100mm(4") from the flexible hose, lift up from 100mm(4") to 550mm(22") and lift down 20mm(3/4") or more.
2. Install horizontal drainpipe with a slope of 1/100 or more and fix it by hanger space of 1~1.5m(3' 3"~4' 11").
3. Install the air vent in the horizontal drainpipe to prevent water flow back to the indoor unit.



• You may not need to install it if there were proper slope in the horizontal drainpipe.

4. The flexible hose should not be installed upward position, it may cause water flow back to the indoor unit.
5. Install U trap at the end of the drainpipe to prevent a nasty smell to reach the indoor unit.

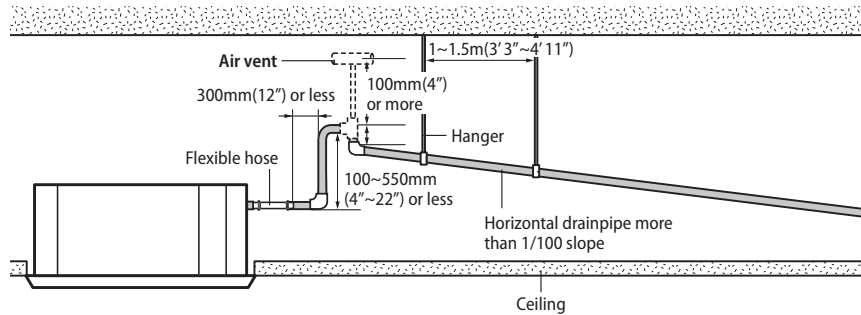

* Flexible hose Installation

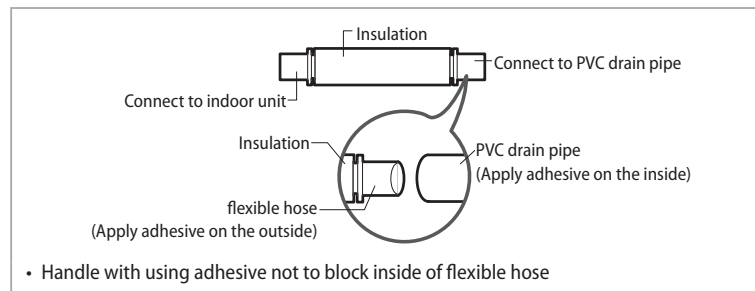
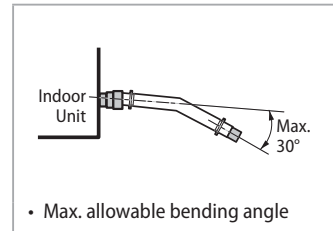
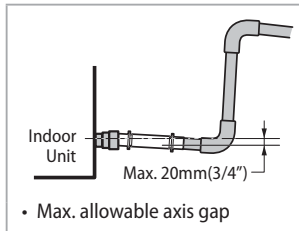
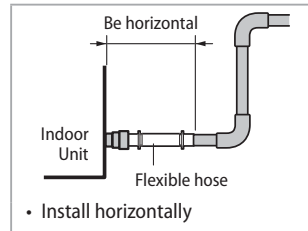

Centralized Drainage

1. Install main air vent at the front of the farthest indoor unit from the main drain when installed indoor units are more than 3.
2. may need to install individual air vent to prevent water flow back at the top of each indoor unit drainpipe.

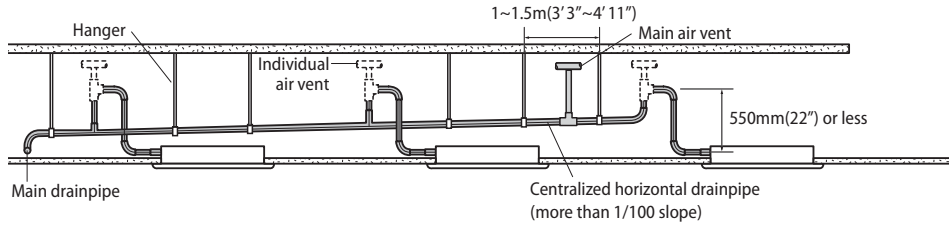

Testing the drainage

You should test the drainage after completing the installation.

Prepare a little water about 1.0 liters.

1. Open the cover water supply intake.
2. Pour water into the water supply intake.

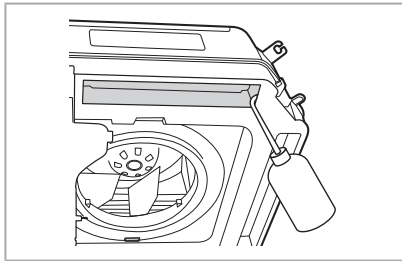

3. Operate the unit in the Cool mode and check a drain pump pumping.
4. Check drain water drops at the end of the drainpipe.

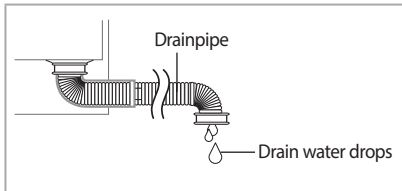

5. Make sure there is no water leak at the drainage.
6. When you finished the test, close the coverside.



• When maintaining the air conditioner, remove condensate water remained in the drain pan by using a drain port for maintenance.

Bushing bracket installation

If the conduit tube is used, bushing bracket must be installed as shown in the picture to fix the conduit tube.

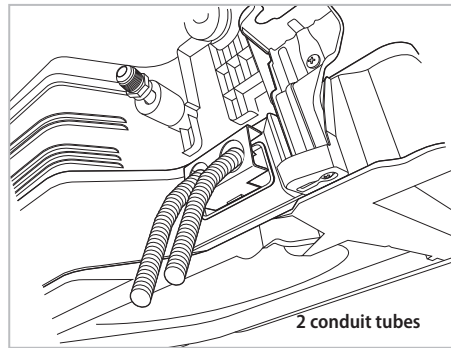
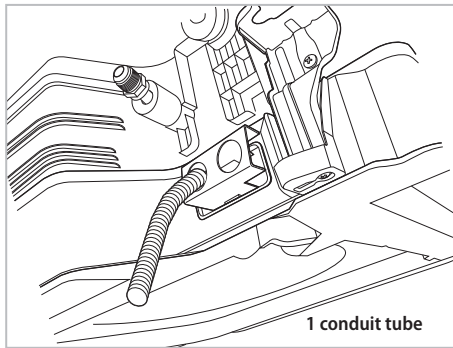
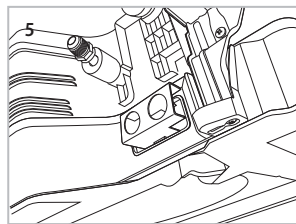
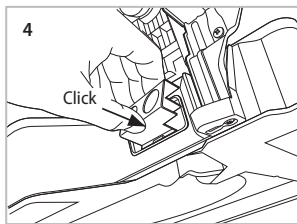
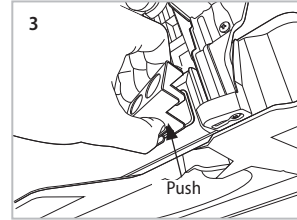
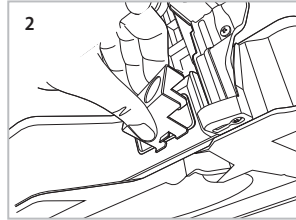
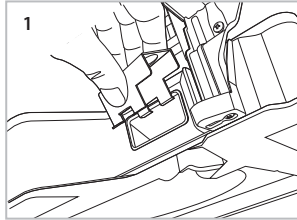

Wiring work

Selecting compressed ring terminal

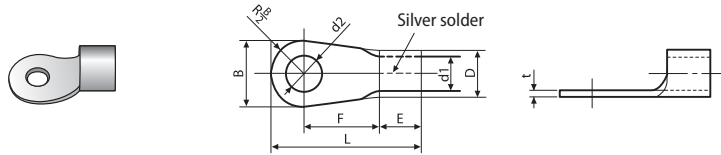

Normal dimensions for cable [mm ² (inch ²)]		1.5 (0.002)		2.5 (0.003)		4 (0.006)
Normal dimensions for screw [mm (inch)]		4 (0.15")		4 (0.15")		4 (0.15")
B	Standard dimension [mm (inch)]	6.6 (0.25")	8.0 (0.31")	6.6 (0.25")	8.5 (0.33")	9.5 (0.37")
	Allowance [mm (inch)]	±0.2 (±0.007")		±0.2 (±0.007")		±0.2 (±0.007")
D	Standard dimension [mm (inch)]	3.4 (0.13")		4.2 (0.16")		5.6 (0.22")
	Allowance [mm (inch)]	+0.3 (+0.011") -0.2 (-0.007")		+0.3 (+0.011") -0.2 (-0.007")		+0.3 (+0.011") -0.2 (-0.007")
d1	Standard dimension [mm (inch)]	1.7 (0.06")		2.3 (0.09")		3.4 (0.13")
	Allowance [mm (inch)]	±0.2 (±0.007")		±0.2 (±0.007")		±0.2 (±0.007")
E	Min. [mm (inch)]	4.1 (3/16")		6 (1/4")		6 (1/4")
F	Min. [mm (inch)]	6 (1/4")		6 (1/4")		6 (1/4")
L	Max. [mm (inch)]	16 (5/8")		17.5 (3/4")		20 (3/4")
d2	Standard dimension [mm (inch)]	4.3 (0.16")		4.3 (0.16")		4.3 (0.16")
	Allowance [mm (inch)]	+0.2 (+0.007") 0 (0")		+0.2 (+0.007") 0 (0")		+0.2 (+0.007") 0 (0")
t	Min.Min. [mm (inch)]	0.7 (0.02")		0.8 (0.03")		0.9 (0.035")

ENGLISH

Connecting the connection cord



- Always remember to connect the refrigerant pipes before performing the electric connections. When disconnecting the system, always disconnect the electric cables before disconnecting the refrigerant pipes.
- Always remember to connect the air conditioner to the grounding system before performing the electric connections.

The indoor unit is powered by the outdoor unit by means of a H07 RN-F connection cable (or a more power model), with insulation in synthetic rubber and jacket in polychloroprene(neoprene), in accordance with the requirements of standard EN 60335-2-40.

1. Remove the screw on the electrical component box and remove the cover plate.
2. Route the connection cord through the side of the indoor unit and connect the cable to terminals; refer to the figure below.
3. Route the other end of the cable to the outdoor unit through the ceiling & the hole on the wall.
4. Reassemble the electrical component box cover, carefully tightening the screw.

Wiring diagram

1 phase

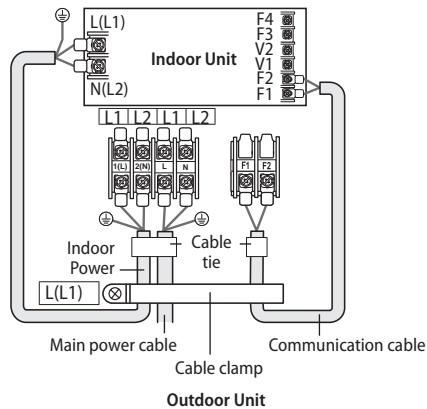

- In case of extending the electric wire, please DO NOT use a round-shaped pressing socket.
- Incomplete wire connections can cause electric shock or a fire.

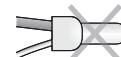

Between Indoor and Outdoor Connection cable Specifications(Common in use)

Indoor Power supply			Communication Cable
Power Supply	Max/Min(V)	Indoor Power cable	
208~230V/60Hz	±10%	0.75~1.5mm ²	0.75~1.5mm ²

- * Power supply cords of parts of appliances for outdoor use shall not be lighter than polychloroprene sheathed flexible cord (Code designation IEC:60245 IEC 57 / CENELEC: H05RN-F or IEC:60245 IEC 66 / CENELEC: H07RN-F)
- * Screws on terminal block must not be unscrewed with the torque less than 12 kgf·cm.
- * Since it has the external power supply, refer to the outdoor unit installation manual for MAIN POWER.

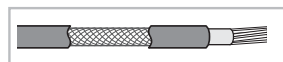

When installing the indoor unit in a computer room, use the double shielded(Tape aluminum / polyester braid + copper)cable of FROHH2R type.

Setting an indoor unit address and installation option

Set the indoor unit address and installation option with remote controller option. Set the each option separately since you cannot set the ADDRESS setting and indoor unit installation setting option at the same time. You need to set twice when setting indoor unit address and installation option.

The procedure of option setting

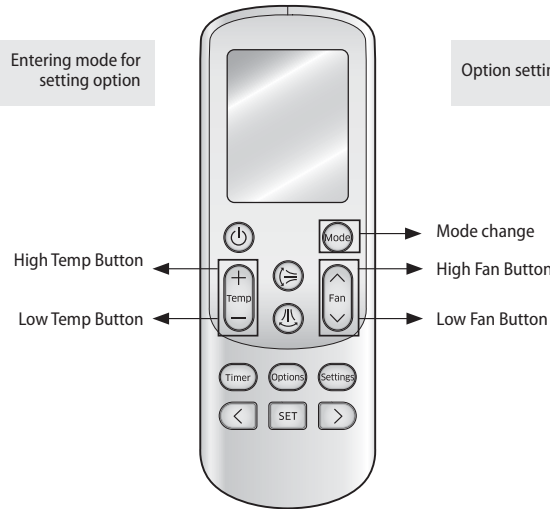

Step 1. Entering mode to set option

1. Remove batteries from the remote controller.
2. Insert batteries and enter the option setting mode while pressing High Temp button and Low Temp button.
3. Check if you have entered the option setting status.



Step 2. The procedure of option setting

After entering the option setting status, select the option as listed below.









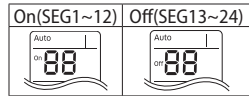



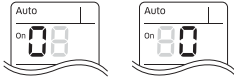

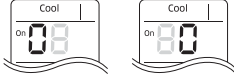
Option setting is available from SEG1 to SEG 24

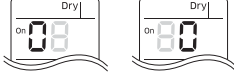



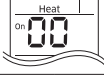
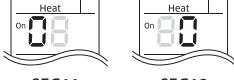

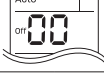
- SEG1, SEG7, SEG13, SEG19 are not set as page option.
- Set the SEG2~SEG6, SEG8~SEG12 as ON status and SEG14~18, SEG20~24 as OFF status.

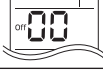
SEG1	SEG2	SEG3	SEG4	SEG5	SEG6	SEG7	SEG8	SEG9	SEG10	SEG11	SEG12
0	X	X	X	X	X	1	X	X	X	X	X
SEG13	SEG14	SEG15	SEG16	SEG17	SEG18	SEG19	SEG20	SEG21	SEG22	SEG23	SEG24
2	X	X	X	X	X	3	X	X	X	X	X

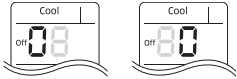

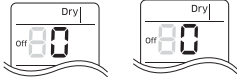
Setting an indoor unit address and installation option

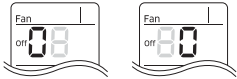
Option setting	Status
<p>1. Setting SEG2, SEG3 option</p> <p>Press Low Fan button() to enter SEG2 value.</p> <p>Press High Fan button() to enter SEG3 value.</p> <p>Each time you press the button, $\text{0} \rightarrow \text{1} \rightarrow \dots \text{E} \rightarrow \text{F}$ will be selected in rotation.</p>	 <p>SEG2 SEG3</p>
<p>2. Setting Cool mode</p> <p> Press Mode button to be changed to Cool mode in the ON status.</p>	
<p>3. Setting SEG4, SEG5 option</p> <p>Press Low Fan button() to enter SEG4 value.</p> <p>Press High Fan button() to enter SEG5 value.</p> <p>Each time you press the button, $\text{0} \rightarrow \text{1} \rightarrow \dots \text{E} \rightarrow \text{F}$ will be selected in rotation.</p>	 <p>SEG4 SEG5</p>
<p>4. Setting Dry mode</p> <p> Press Mode button to be changed to DRY mode in the ON status.</p>	
<p>5. Setting SEG6, SEG8 option</p> <p>Press Low Fan button() to enter SEG6 value.</p> <p>Press High Fan button() to enter SEG8 value.</p> <p>Each time you press the button, $\text{0} \rightarrow \text{1} \rightarrow \dots \text{E} \rightarrow \text{F}$ will be selected in rotation.</p>	 <p>SEG6 SEG8</p>
<p>6. Setting Fan mode</p> <p> Press Mode button to be changed to FAN mode in the ON status.</p>	
<p>7. Setting SEG9, SEG10 option</p> <p>Press Low Fan button() to enter SEG9 value.</p> <p>Press High Fan button() to enter SEG10 value.</p> <p>Each time you press the button, $\text{0} \rightarrow \text{1} \rightarrow \dots \text{E} \rightarrow \text{F}$ will be selected in rotation.</p>	 <p>SEG9 SEG10</p>
<p>8. Setting Heat mode</p> <p> Press Mode button to be changed to HEAT mode in the ON status.</p>	
<p>9. Setting SEG11, SEG12 option</p> <p>Press Low Fan button() to enter SEG11 value.</p> <p>Press High Fan button() to enter SEG12 value.</p> <p>Each time you press the button, $\text{0} \rightarrow \text{1} \rightarrow \dots \text{E} \rightarrow \text{F}$ will be selected in rotation.</p>	 <p>SEG11 SEG12</p>
<p>10. Setting Auto mode</p> <p> Press Mode button to be changed to AUTO mode in the OFF status.</p>	
<p>11. Setting SEG14, SEG15 option</p> <p>Press Low Fan button() to enter SEG14 value.</p> <p>Press High Fan button() to enter SEG15 value.</p> <p>Each time you press the button, $\text{0} \rightarrow \text{1} \rightarrow \dots \text{E} \rightarrow \text{F}$ will be selected in rotation.</p>	 <p>SEG14 SEG15</p>
<p>12. Setting Cool mode</p> <p> Press Mode button to be change to Cool mode in the OFF status.</p>	

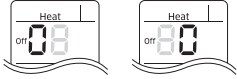
Option setting	Status
13. Setting SEG16, SEG17 option Press Low Fan button() to enter SEG16 value. Press High Fan button() to enter SEG17 value. Each time you press the button, $\text{OFF} \rightarrow \text{H} \rightarrow \dots \text{E} \rightarrow \text{F}$ will be selected in rotation.	 SEG16 SEG17
14. Setting Dry mode (Mode) Press Mode button to be change to Dry mode in the OFF status.	
15. Setting SEG18, SEG20 option Press Low Fan button() to enter SEG18 value. Press High Fan button() to enter SEG20 value. Each time you press the button, $\text{OFF} \rightarrow \text{H} \rightarrow \dots \text{E} \rightarrow \text{F}$ will be selected in rotation.	 SEG18 SEG20
16. Setting Fan mode (Mode) Press Mode button to be change to Fan mode in the OFF status.	
17. Setting SEG21, SEG22 option Press Low Fan button() to enter SEG21 value. Press High Fan button() to enter SEG22 value. Each time you press the button, $\text{OFF} \rightarrow \text{H} \rightarrow \dots \text{E} \rightarrow \text{F}$ will be selected in rotation.	 SEG21 SEG22
18. Setting Heat mode (Mode) Press Mode button to be change to HEAT mode in the OFF status.	
19. Setting SEG23, SEG24 mode Press Low Fan button() to enter SEG23 value. Press High Fan button() to enter SEG24 value. Each time you press the button, $\text{OFF} \rightarrow \text{H} \rightarrow \dots \text{E} \rightarrow \text{F}$ will be selected in rotation.	 SEG23 SEG24

Step 3. Check the option you have set

After setting option, press (Mode) button to check whether the option code you input is correct or not.

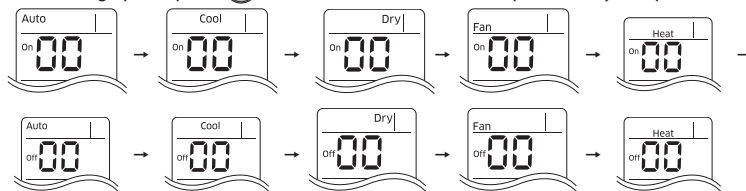

Step 4. Input option

Press operation button () with the direction of remote control for set.

For the correct option setting, you must input the option twice.

Step 5. Check operation

- 1) Reset the indoor unit by pressing the RESET button of indoor unit or outdoor unit.
- 2) Take the batteries out of the remote controller and insert them again and then press the operation button.

Setting an indoor unit address and installation option

SEG 3, 4, 5, 6, 8, 9 additional information

When the SEG 3 is set as "1" and follow Auto Change Over for HR only operation, it will operate as follows.

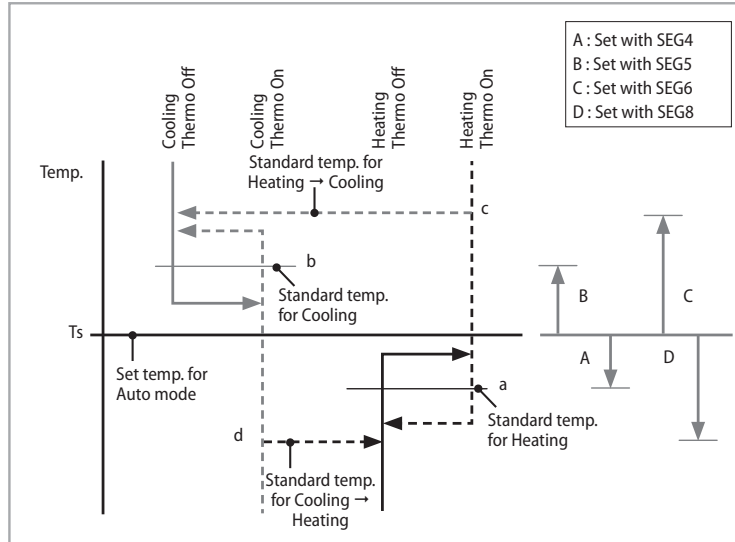

* Cooling/Heating mode can be changed when Thermo Off status is maintained during the time with SEG9.

Setting an indoor unit address (MAIN/RMC)

1. Check whether power is supplied or not.
 - ▶ When the indoor unit is not plugged in, there should be additional power supply in the indoor unit.
2. The panel(display) should be connected to an indoor unit to receive option.
3. Before installing the indoor unit, assign an address to the indoor unit according to the air conditioning system plan.
4. Assign an indoor unit address by wireless remote controller.
 - ▶ The initial indoor unit ADDRESS is set as "MAIN : 0, RMC : 0".
 - ▶ Set Main and RMC Address only the setting is required.
 - ▶ There is no need to assign the indoor unit Main Address if the outdoor unit is addressing automatically. The indoor unit Main address will follow the outdoor unit's automatically.
 - ▶ Assign 12 digit when setting the indoor unit address.
 - ▶ No need to assign SEG4, 5, 8, 10 which are non applicable. Even though those segments are set, they will be ignored.
 - ▶ If you set the applicable segments with numbers other than the indicated, the initial setting will be maintained.

Option No. : 0AXXXX-1XXXXX-2XXXXX-3XXXXX

Option	SEG1		SEG2		SEG3		SEG4	SEG5	SEG6		
Explanation	PAGE		MODE		Setting Main address		RESERVED	RESERVED	The unit digit of an indoor unit		
Indication and Details	Indication	Details	Indication	Details	Indication	Details			Indication	Details	
	0		A		0	No Main address			0~3	A single digit	
					1	Main address setting mode					
Option	SEG7		SEG8		SEG9		SEG10	SEG11		SEG12	
Explanation	PAGE		RESERVED		Setting RMC address		RESERVED	Group channel(*16)		Group address	
Indication and Details	Indication	Details			Indication	Details		Indication	Details	Indication	Details
	1				0	No RMC address		RMC1	0~2	RMC2	0~F
			1	RMC address setting mode							

CAUTION

- You can set the Main address(SEG6) 0~3 range and if you set other numbers,"communication error"will occur.
- If you set the SEG 3 as 0, the indoor unit will maintain the previous MAIN ADDRESS even if you input the option value of SEG6.
- If you set the SEG 9 as 0, the indoor unit will maintain previous RMC ADDRESS even if you input the option value of SEG11~12.

Example) If you want to set as "MAIN : 3, CHANNEL : 1, RMC : B";

SEG1	SEG2	SEG3	SEG4	SEG5	SEG6
0	A	1	-	-	3
SEG7	SEG8	SEG9	SEG10	SEG11	SEG12
1	-	1	-	1	B

assign option codes except SEG 1, 7 which are page options.

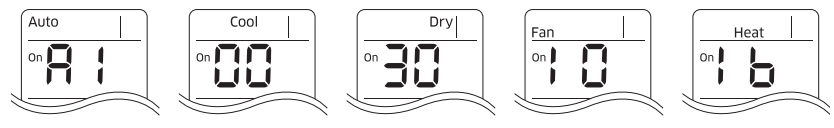

Setting an indoor unit address and installation option

Setting an indoor unit installation option (suitable for the condition of each installation location)

1. Check whether power is supplied or not.
 - ▶ When the indoor unit is not plugged in, there should be additional power supply in the indoor unit.
2. The panel(display) should be connected to an indoor unit to receive option.
3. Set the installation option according to the installation condition of an air conditioner.
 - ▶ The default setting of an indoor unit installation option is "02000-100000-200000-300000".
 - ▶ Individual control of a remote controller(SEG20) is the function that controls an indoor unit individually when there is more than one indoor unit.
 - ▶ No need to assign SEG3, 6, 9, 10, 11, 16, 21, 22, 23, 24 which are non applicable. Even though those segments are set, they will be ignored.
 - ▶ If you set the applicable segments with numbers other than the indicated, the initial setting will be maintained.
4. Set the indoor unit option by wireless remote controller.

Option No. : 02XXXX-1XXXXX-2XXXXX-3XXXXX

Option	SEG1		SEG2		SEG3		SEG4		SEG5		SEG6		
Explanation	PAGE		MODE		RESERVED		Use of external temperature sensor		Use of central control		RPM setting compensation		
Indication and Details	Indication	Details	Indication	Details			Indication	Details	Indication	Details	0. Not used		
	0		2				0	Disuse	0	Disuse	1. High ceiling mode		
					1	Use	1	Use	2. High ceiling kit				
Option	SEG7		SEG8		SEG9		SEG10		SEG11		SEG12		
Explanation	PAGE		Use of drain pump		RESERVED		RESERVED		RESERVED		Master / Slave		
Indication and Details	Indication	Details	Indication	Details							Indication	Details	
	1		0	Disuse							0	slave	
			1	Use	1	master							
			2	Use + 3minute delay									
Option	SEG13		SEG14		SEG15		SEG16		SEG17		SEG18		
Explanation	PAGE		Use of external control		Setting the output of external control		S-Plasma ion		Buzzer control		Number of hours using filter		
Indication and Details	Indication	Details	Indication	Details	Indication	Details	Indication	Details	Indication	Details	Indication	Details	
	2		0	Disuse	0	Thermo on	0	Disuse	0	Use of buzzer	2	1000 Hour	
			1	ON/OFF Control	1	Operation on	1	Use	1	Non use of buzzer	6	2000 Hour	
2			OFF Control										

Option	SEG19		SEG20		SEG21		SEG22	SEG23	SEG24
Explanation	PAGE		Individual control of a remote controller		Heating setting compensation		RESERVED	RESERVED	RESERVED
Indication and Details	Indication	Details	Indication	Details	Indication	Details			
	3		0 or 1	Indoor 1	0	Disuse			
			2	Indoor 2	1	2°C			
			3	Indoor 3	2	5°C			
4	Indoor 4								

▶ If you input a number other than 0~4 on the individual control of the indoor unit(SEG 20), the indoor is set as "Indoor 1".
 Example) If you want to set as "Exterior temperature sensor : USE, External control : USE, Number of hours using filter : 2000hr",

SEG1	SEG2	SEG3	SEG4	SEG5	SEG6
0	2	-	1	0	-
SEG7	SEG8	SEG9	SEG10	SEG11	SEG12
1	0	-	-	-	0
SEG13	SEG14	SEG15	SEG16	SEG17	SEG18
2	1	0	-	0	6
SEG19	SEG20	SEG21	SEG22	SEG23	SEG24
3	0	-	-	-	-

assign option codes except SEG 1, 7, 13, 19 which are page options.

Changing a particular option

You can change each digit of set option.

Option	SEG1		SEG2		SEG3		SEG4		SEG5		SEG6	
Explanation	PAGE		MODE		The option mode you want to change		The tens' digit of an option SEG you will change		The unit digit of an option SEG you will change		The changed value	
Indication and Details	Indication	Details	Indication	Details	Indication	Details	Indication	Details	Indication	Details	Indication	Details
	0		D		Option mode	0~F	Tens' digit of SEG	0~9	Unit digit of SEG	0~9	The changed value	0~F



























- When changing a digit of an indoor unit address setting option, set the SEG3 as 'A'.
- When changing a digit of indoor unit installation option, set the SEG3 as '2'.

Ex) When setting the 'buzzer control' into disuse status.

Option	SEG1	SEG2	SEG3	SEG4	SEG5	SEG6
Explanation	PAGE	MODE	The option mode you want to change	The tens' digit of an option SEG you will change	The unit digit of an option SEG you will change	The changed value
Indication	0	D	2	1	7	1

Troubleshooting

Abnormal conditions	LED lamp display				Remarks
	Operation	Defrost	Timer	Filter	
					
Error of temperature sensor in the indoor unit (Open/Short)	X		X	X	
Error of EVA IN, OUT sensor in the indoor unit(Open/Short)			X	X	
Error of fan motor in the indoor unit	X	X		X	
Error of outdoor sensor (outdoor temp./cond/discharge)		X		X	
No communication for 2 minutes between indoor and outdoor unit	X			X	
Error of outdoor unit/Self-Diagnosis (Check error code at outdoor unit's or solution display)	X				
Detection of the float switch	X	X			
EEPROM error/EEPROM option error					
High pressure blockage error		X			

● On ● Flickering X Off

▶ If you turn off the air conditioner when the LED is flickering, the LED is also turned off.

Wired remote control

If an error occurs,  is displayed on the wired remote control. If you would like to see an error code, press the Test button.

Display	Explanation	Remark
478	Compressor down due to protection control of the discharge temperature sensor	Error about protection control of the outdoor unit
450	Control due to the condenser temperature sensor when cooling mode	
458	Error of the low pressure switch (Protection control)	
425	Reverse phase error (Protection control)	
558	In removing frost	
228	Error of the outdoor temperature sensor (Open/Short)	Error about the outdoor unit sensor (Open/Short)
230	Error of condenser temperature sensor (Open/Short)	Detection during the operation of the indoor unit (sensing and sending errors into the communication data)
258	Error of discharge temperature sensor (Open/Short)	
208	- System down caused by communication error after completion of tracking - Mismatching of the indoor unit numbers set with those communication after completion of 5 times tracking	
828	Error of temperature sensor in the indoor unit (Open/Short)	Self-diagnosis of the indoor and outdoor unit
822	Error of the heat exchanger sensor in the indoor unit (Open/Short)	
479	Error of electronic expansion valve open in the outdoor unit (when it is detected more than once)	
422	Error of electronic expansion valve close in the outdoor unit (when it is detected more than once)	
608	Error of communication between the indoor unit and the wired remote controller	Wired remote controller errors
602	Master wired remote controllerSlave wired remote controller	
606	COM1/COM2 Cross-installed error	
868	Error of setting option for wired remote controller COM2	

MEMO

MEMO





QUESTIONS OR COMMENTS?

COUNTRY	CALL	OR VISIT US ONLINE AT
CANADA	1-800-SAMSUNG(726-7864)	www.samsung.com/ca/support (English) www.samsung.com/ca_fr/support (French)
MEXICO	01-800-SAMSUNG(726-7864)	www.samsung.com
U.S.A - Consumer Electronics	1-800-SAMSUNG(726-7864)	www.samsung.com
ARGENTINE	0800-333-3733	www.samsung.com
URUGUAY	40543733	www.samsung.com
PARAGUAY	98005420001	www.samsung.com
BRAZIL	0800-124-421 4004-0000	www.samsung.com
CHILE	800-SAMSUNG(726-7864) From mobile 02-24 82 82 00	www.samsung.com/cl
BOLIVIA	800-10-7260	www.samsung.com
COLOMBIA	01-8000 112 112 Bogotá: 6001272	www.samsung.com/co
COSTA RICA	0-800-507-7267	www.samsung.com/latin (Spanish) www.samsung.com/latin_en (English)
DOMINICA	1-800-751-2676	www.samsung.com/latin (Spanish) www.samsung.com/latin_en (English)
ECUADOR	1-800-10-7267	www.samsung.com/latin (Spanish) www.samsung.com/latin_en (English)
NICARAGUA	00-1800-5077267	www.samsung.com
HONDURAS	800-7919267	www.samsung.com
EL SALVADOR	800-6225	www.samsung.com/latin (Spanish) www.samsung.com/latin_en (English)
GUATEMALA	1-800-299-0013	www.samsung.com/latin (Spanish) www.samsung.com/latin_en (English)
HONDURAS	800-27919267	www.samsung.com/latin (Spanish) www.samsung.com/latin_en (English)
JAMAICA	1-800-234-7267	www.samsung.com
NICARAGUA	00-1800-5077267	www.samsung.com/latin (Spanish) www.samsung.com/latin_en (English)
PANAMA	800-7267	www.samsung.com/latin (Spanish) www.samsung.com/latin_en (English)
PERU	0-800-777-08(Only from landline) 336-8686 (From HHP & landline)	www.samsung.com
PUERTO RICO	1-800-682-3180	www.samsung.com
TRINIDAD & TOBAGO	1-800-SAMSUNG (726-7864)	www.samsung.com
VENEZUELA	0-800-100-5303	www.samsung.com
PHILIPPINES	1-800-10-SAMSUNG(726-7864) for PLDT 1-800-3-SAMSUNG(726-7864) for Digitel 1-800-8-SAMSUNG(726-7864) for Globe 02-5805777	www.samsung.com/ph