

QUIETSIDE



# Split Air Conditioner

OWNER'S MANUAL

---

QUIETSIDE AIR CONDITIONERS

QSVSI-09A QSVSO-09A  
QSVSI-12A QSVSO-12A

Thank you for choosing QUIETSIDE air conditioner. For correct operation, please read this owner's manual carefully before operating the unit and keep it carefully for consultation.

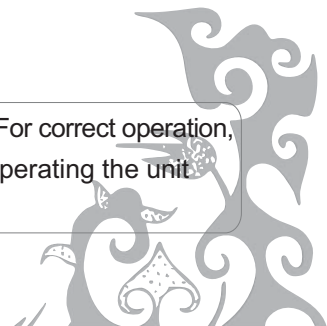

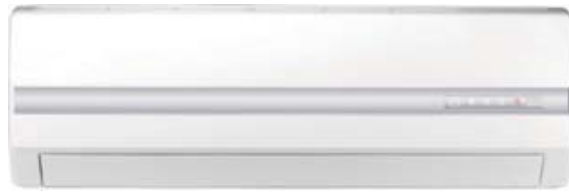

QSVSI-09A  
QSVSI-12A

## ◆ CONTENTS

### Operation and maintenance

■ Notices for operation . . . . .	1
■ Notices for use . . . . .	3
■ Names and functions of each part . . . . .	5
■ Operation of wireless remote control . . . . .	6
■ Emergency operation . . . . .	11
■ Clean and care . . . . .	12
■ Troubleshooting . . . . .	14

### Installation service

■ Notices for installation . . . . .	17
■ Installation dimension diagram . . . . .	19
■ Install indoor unit . . . . .	20
■ Install outdoor unit . . . . .	22
■ Check after installation and test operation . . . . .	23
■ Installation and Maintenance of Healthy Filter . . . . .	24



This symbol stands for the items should be forbidden.



This symbol stands for the items should be followed

Thank you for choosing QUIETSIDE air conditioner, please read this owner's manual carefully before operating the unit and keep it carefully for consultation.

The products in this manual may be different with the real one, according to different models, some models have displayer and some models without displayer, the position and shape of the displayer please refer to the real one.

This appliance is not intended for use by persons (including children) with reduced physical, sensory or mental capabilities or lack of experience and knowledge, unless they have been given supervision or instruction concerning use of the appliance by a person responsible for their safety.  
Children should be supervised to ensure that they do not play with the appliance.





Do not dispose this product as unsorted municipal waste. Collection of such waste separately for special treatment is necessary.



Image shown in this operating instruction manual here is indicative only. Actual product you receive may differ!

◆ Operation and maintenance-notice for operation

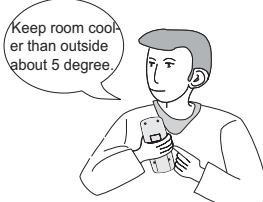
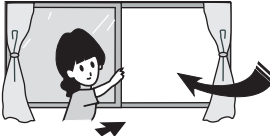
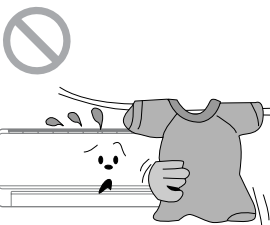
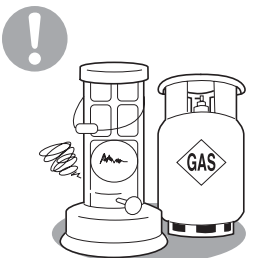
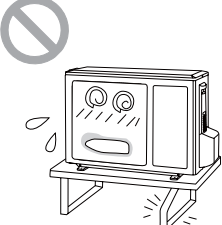
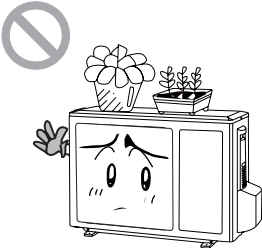
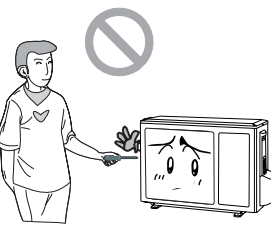
<p>⚠ ★ Earth: The ground be connected!</p>  <p>If not, please ask the qualified personnel to install. Furthermore, don't connect each wire to the gas pipe, water pipe, drainage pipe or any other improper places</p>	<p>★ Be sure to disconnected the power plug when not using the air conditioner for a long time.</p>  <p>Otherwise, the accumulated dust may cause fire or electric shock.</p>	<p>★ Select the most appropriate temperature.</p>  <p>Keep room cooler than outside about 5 degree.</p> <p>It can preclude the electricity wasted.</p>
<p>★ Don't leave windows and doors open for a long time while operating the air conditioner.</p>  <p>It can decrease the air conditioning capacity.</p>	<p>★ Don't block the air intake or outlet vents of both the outdoor and indoor units.</p>  <p>It can decrease the air conditioning capacity or cause a malfunction.</p>	<p>★ Keep combustible spray away from the units more than 1m.</p>  <p>It can cause afire or explosion.</p>
<p>★ Please note whether the installed stand is firm enough or not.</p>  <p>If it is damaged, it may lead to the fall of the unit and cause the injury.</p>	<p>★ Don't step on the top of the outdoor unit or place something on it.</p>  <p>As falling off the outdoor unit can be dangerous.</p>	<p>★ Don't attempt to repair the air conditioner by yourself.</p>  <p>The wrong repair will lead to an electric shock or fire, so you should contact the service center to repair.</p>

## ◆ Notices for operation

- ★ If the supply cord is damaged, it must be replaced by the manufacturer or its service agent or a similarly qualified person in order to avoid a hazard.



- ★ The airflow direction can be adjusted appropriately. At operating, adjust the vertical airflow direction by adjusting the louvers of upward/downward direction. And then, hold two ends of left and right louver to adjust the horizontal airflow.

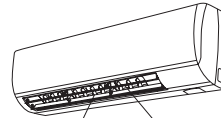

Louver of left/right direction      Louver of upward/downward direction.

- ★ Don't insert your hands or stick into the air intake or outlet vents.



Otherwise it will cause accident.

- ★ Don't blow the wind to animals and plants directly. It can cause a bad influence to them.

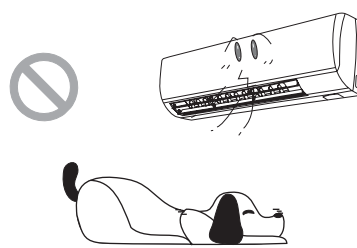

- ★ Don't apply the cold wind to the body for a long time.

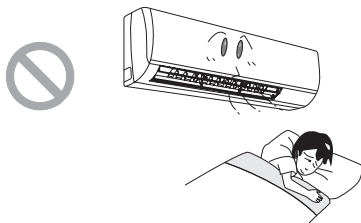

It can cause the health problems.

- ★ Don't use the air conditioner for other purposes, such as drying clothes, preserving foods, etc.

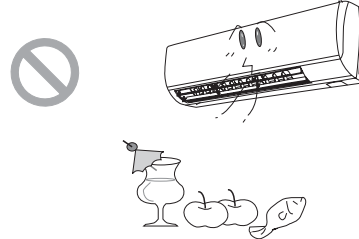

- ★ Splashing water on the air conditioner can cause an electric shock and malfunction.

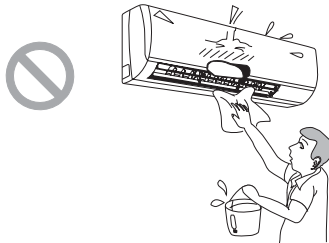

- ★ Don't place a space heater near the air conditioner.

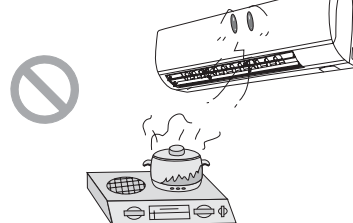

Or CO toxicosis may occur for incomplete burning.

## ◆ Notices for use

### Working principle and special functions for cooling

#### Principle:

Air conditioner absorbs heat in the room and transmit to outdoor and discharged, so that indoor ambient temperature decreased, its cooling capacity will increase or decrease by outdoor ambient temperature.

#### Anti-freezing function:

If the unit is running in COOL mode and in low temperature, there will be frost formed on the heat exchanger, when indoor heat exchanger temperature decreased below 32°F, the indoor unit microcomputer will stop compressor running and protect the unit.

### Working principle and special functions for heating

#### Principle:

- \* Air conditioner absorbs heat from outdoor and transmits to indoor, in this way to increase room temperature. This is the heat pump heating principle, its heating capacity will be reduced due to outdoor temperature decrease.
- \* If outdoor temperature becomes very low, please operate with other heating equipments.

#### Defrosting:

- \* When outdoor temperature is low but high humidity, after a long while running, frost will form on outdoor unit, that will effect the heating effect, at this time, the auto defrosting function will act, the heat running will stop for 8-10mins.
- \* During the auto defrosting, the fan motors of indoor unit and outdoor unit will stop.
- \* During the defrosting, the indoor indicator flashes, the outdoor unit may emit vapor. This is due to the defrosting, it isn't malfunction.
- \* After defrosting finished, the heating will recover automatically.

◆ Notices for use

**Anti-cool wind function:**

In "Heat" mode, under the following three kinds of state, if indoor heat exchanger doesn't arrive at certain temp., indoor fan will not act, in order to prevent cool wind blowing(within 2 mins):

1. Heating starts.
2. After Auto Defrost finished.
3. Heating under the low temperature.

※ Working temperature range		
	Indoor sideDB/WB(°F)	Outdoor sideDB/WB(°F)
Maximum cooling	95/75	115/86
Minimum cooling	70/59	70/-
Maximum heating	75/-	75/60
Minimum heating	68/-	5/-

The operating temperature range (outdoor temperature) for cooling unit is 41°F~115°F ;  
for cooling and heating unit is 5°F~115°F.

◆ Names and functions of each part

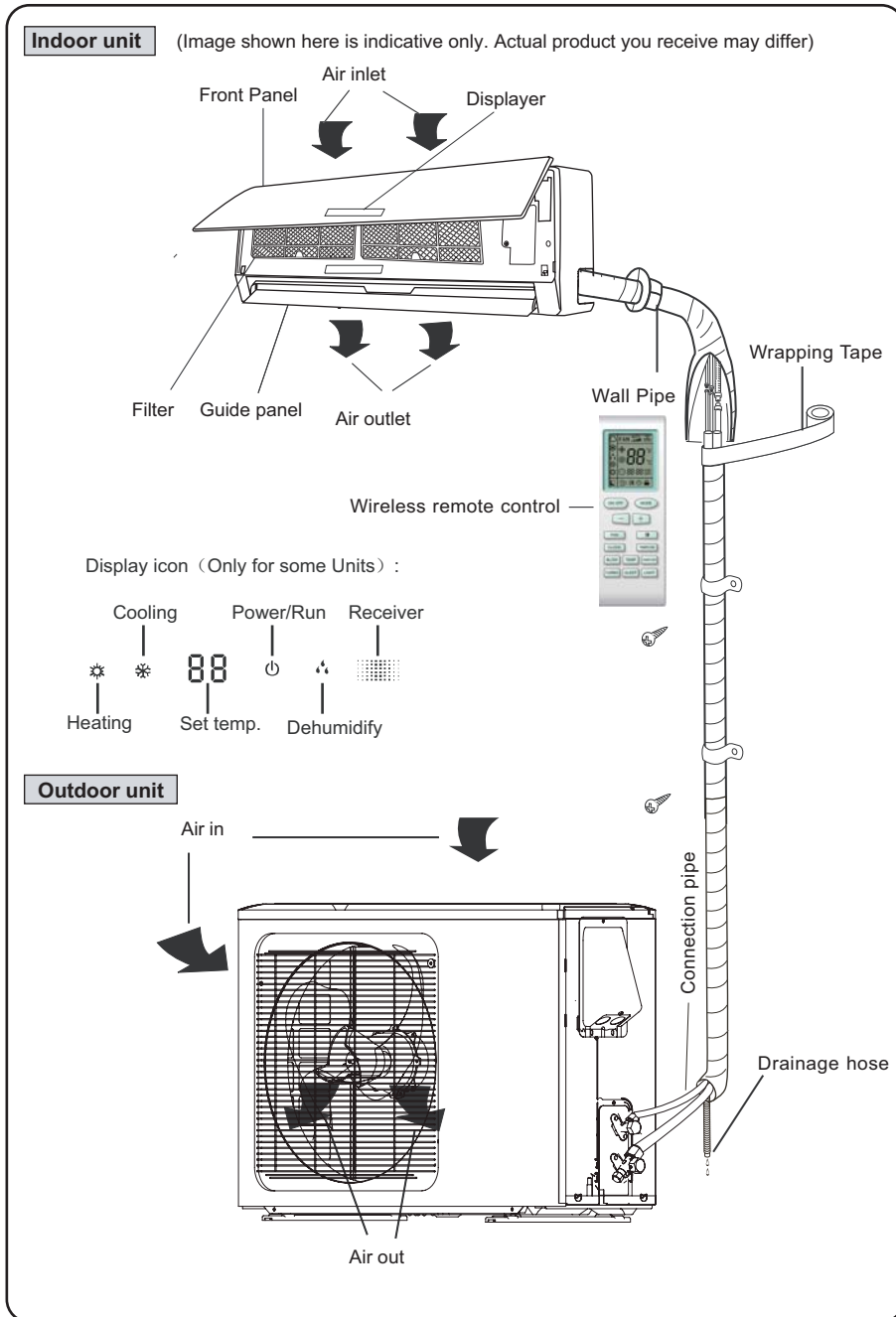



## ◆ Operation of wireless remote control

### Names and functions of wireless remote control

**Note:** Be sure that there are no obstructions between receiver and remote controller; Don't drop or throw the remote control; Don't let any liquid in the remote control and put the remote control directly under the sunlight or any place where is very hot.

**Signal transmitter**



**Remote control**

**SLEEP**

**SLEEP button**

- Press this button, Sleep On and Sleep Off can be selected. After powered on, Sleep Off is defaulted. After the unit is turned off, the Sleep function is canceled. After Sleep function set up, the signal of Sleep will display. In this mode, the time of timer can be adjusted. Under Fan and Auto modes, this function is not available.

**FAN**

**FAN button**

- Press this button, Auto, Low, Middle, High speed can be circularly selected. After powered on, Auto fan speed is default. Under Dehumidify mode, Low fan speed only can be set up.

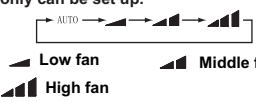

▲ Low fan      ▲ Middle fan  
▲ High fan

**Note:** Under the Dry mode, the fan speed isn't adjustable, low fan speed is imperative, but when operating this button, the wireless adjustable, low fan speed is imperative,

**CLOCK**

**CLOCK button**

- Press this button, the clock can be set up, signal ⊕ blink and display. Within 5 seconds, the value can be adjusted by pressing + or - button, if continuously press this button for 2 seconds above, in every 0.5 seconds, the value on ten place of Minute will be increased 1. During blinking, repress the Clock button, signal ⊕ will be constantly displayed and it denotes the setting succeeded. After powered on, 12:00 is defaulted to display and signal ⊕ will be displayed. If there is signal ⊕ be displayed that denotes the current time value is Clock value, otherwise is Timer value.

**LIGHT**

**LIGHT button**

- Press this button to select LIGHT on or off in the displayer. When the LIGHT is on set, the icon ☹ will be displayed and the indicator light in the displayer will be on. When the LIGHT off is set, the icon ☹ will be displayed and the indicator light in the displayer will be off.

**ON/OFF**

**ON/OFF button**

- Press this button, the unit will be turned on, press it once more, the unit will be turned off. When turning on or turning off the unit, the Timer, Sleep function will be canceled, but the presetting time is still remained.

**MODE**

**MODE button**

- Press this button, Auto, Cool, Dry, Fan, Heat mode can be selected circularly. Auto mode is default while power on. Under Auto mode, the temperature will not be displayed; Under Heat mode, the initial value is 28°C (82°F); Under other modes, the initial value is 25°C (77°F).

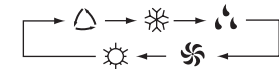

△ AUTO  
❄ COOL  
💧 DRY  
🌀 FAN  
☀ HEAT  
(only for cooling and heating unit)

## ◆ Operation of wireless remote control

### Names and functions of wireless remote control

**Notice:** This is a general use remote controller, it could be used for the air conditioners with multifunction; For some function, which the model doesn't have, if press the corresponding button on the remote controller that the unit will keep the original running status.



Remote control

#### BLOW

##### BLOW button

- Press this button, can turn on or turn off the drying. In Cool and Dehumidifying mode, press this button and will display "BLOW", at this time the Blow is turned on. If repress this button, "BLOW" will be concealed, at this time the Blow function is turned off. After powered on, Blow OFF is defaulted. When operating the ON/OFF button, or switching mode to Cool or Dehumidifying mode, the Blow function will keep the original status. If unit is turned off, Blow OFF only can be set up and send the signal. In Auto, Fan as well as Heat mode, Blow function can not be set up and there is no "BLOW" displaying.

##### - button

- Presetting temperature can be decreased. Press this button, the temperature can be set up, continuously press this button and hold for two seconds, the relative contents can quickly change, until unhold this button and send the order that the °C (°F) signal will be displayed all the time. The temperature adjustment is unavailable under the Auto mode, but the order can be sent by if pressing this button.

+

##### + button

- For presetting temperature increasing. Press this button, can set up the temperature, when unit is on. Continuously press and hold this button for more than 2 seconds, the corresponding contents will be changed rapidly, until unpress the button then send the information, °C (°F) is displaying all along. In Auto mode, the temperature can not be set up, but operate this button can send the signal. Centigrade setting range :16-30; Fahrenheit scale setting range 61-86.

#### TURBO

##### TURBO button

- In Cool or Heat mode, press this button can turn on or turn off the Turbo function. After turned on the Turbo function, its signal will be displayed. When switching the mode or changing fan speed, this function will be canceled automatically.

#### TEMP

##### TEMP button

- Press this button, could select displaying the indoor setting temperature or indoor ambient temperature. When the indoor unit firstly power on it will display the setting temperature, if the temperature's displaying status is changed from other status to "⬆️", displays the ambient temperature, 5s later or within 5s, it receives other remote control signal that will return to display the setting temperature. If the users haven't set up the temperature displaying status, that will display the setting temperature. (This function is applicable to partial of models)
- After powered on, the setting temperature displaying is defaulted, (according to customers requirements to display, if there is no requirement that will default to display the presetting temperature and there is no icon displayed on wireless remote control). Press this button, (When displaying ⬆️), will display presetting temperature; (when displaying ⬆️) will display indoor ambient temperature, ⬆️ current displaying status will not be changed. If current displays indoor ambient temperature, if received the other remote control signal, it will display presetting temperature, 5s later, will back to display the ambient temperature. (This function is applicable to partial of models)

## ◆ Operation of wireless remote control

### Names and functions of wireless remote control

**Notice:** This is a general use remote controller, it could be used for the air conditioners with multifunction; For some function, which the model doesn't have, if press the corresponding button on the remote controller that the unit will keep the original running status.



Remote control



#### SWING UP AND DOWN BUTTON

- Press this button, to set up swing angle, which circularly changes as below:



This is an universal use remote controller. If remote controller sends the following three kinds of status that the swing status of main unit will be:



When the guide louver start to swing up and down, if turn off the Swing, the air guide louver will stop at current position.

- which indicates the guide louver swings up and down between that all five positions.

TIMER ON

#### TIMER ON BUTTON

- Timer On setting: Signal "ON" will blink and display, signal will conceal, the numerical section will become the timer on setting status. During 5 seconds blink, by pressing + or - button to adjust the time value of numerical section, every press of that button, the value will be increased or decreased 1 minute. Hold pressing + or - button, 2 seconds later, it quickly change, the way of change is: During the initial 2.5 seconds, ten numbers change in the one place of minute, then the one place is constant, ten numbers change in the tens place of minute at 2.5 seconds speed and carry. During 5s blink, press the Timer button, the timer setting succeeds. The Timer On has been set up, repress the timer On button, the Timer On will be canceled. Before setting the Timer, please adjust the Clock to the current actual time.

TIMER OFF

#### TIMER OFF BUTTON

- Once press this key to enter into TIMER OFF setup, in which case the TIMER OFF icon will blink. The method of setting is the same as for TIMER ON.

## ◆ Operation of wireless remote control

### Guide for operation- General operation

1. After powered on, press ON/OFF button, the unit will start to run.(Note: When it is powered off, the guide louver of main unit will close automatically.)
2. Press MODE button, select desired running mode.
3. Pressing + or - button, to set the desired temperature. (It is unnecessary to set the temp. at AUTO mode.)
4. Pressing FAN button, set fan speed, can select AUTO FAN, LOW, MID and HIGH.
5. Pressing  button, to select the swing.

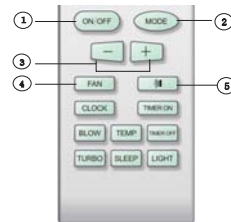

### Guide for operation- Optional operation

1. Press SLEEP button, to set sleep.
2. Press TIMER ON and TIMER OFF button, can set the scheduled timer on or timer off.
3. Press LIGHT button, to control the on and off of the displaying part of the unit (This function may be not available for some units).
4. Press TURBO button, can realize the ON and OFF of TURBO function.

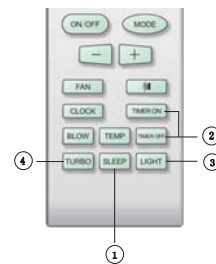

### Introduction for special function

#### ★ About blow function

This function indicates that moisture on evaporator of indoor unit will be blown after the unit is stopped to avoid mould.

1. Having set blow function on: After turning off the unit by pressing ON/OFF button indoor fan will continue running for about 10 min. at low speed. In this period, press blow button to stop indoor fan directly.
2. Having set blow function off: After turning off the unit by pressing ON/OFF button, the complete unit will be off directly.

#### ★ About AUTO RUN

When AUTO RUN mode is selected, the setting temperature will not be displayed on the LCD, the unit will be in accordance with the room temp. automatically to select the suitable running method and to make ambient comfortable.

#### ★ About turbo function



If start this function, the unit will run at super-high fan speed to cool or heat quickly so that the ambient temp. approaches the preset temp. as soon as possible.

## ◆ Operation of wireless remote control

### ★ About lock

Press + and - buttons simultaneously to lock or unlock the keyboard. If the remote controller is locked, the icon  will be displayed on it, in which case, press any button, the mark will flicker for three times. If the keyboard is unlocked, the mark will disappear.

### ★ About swing up and down

1. Press swing up and down button continuously more than 2s, the main unit will swing back and forth from up to down, and then loosen the button, the unit will stop swinging and present position of guide louver will be kept immediately.
2. Under swing up and down mode, when the status is switched from off to , if press this button again 2s later,  status will switch to off status directly; if press this button again within 2s, the change of swing status will also depend on the circulation sequence stated above.

### ★ About switch between Fahrenheit and Centigrade

With unit turned off, press MODE and - buttons simultaneously to switch °C and °F.

### Changing batteries and notices

1. Slightly to press the place with , along the arrowhead direction to push the back cover of wireless remote control. (As show in figure)
2. Take out the old batteries. (As show in figure)
3. Insert two new AAA1.5V dry batteries, and pay attention to the polarity. (As show in figure)
4. Attach the back cover of wireless remote control. (As show in figure)

### ★ NOTE:

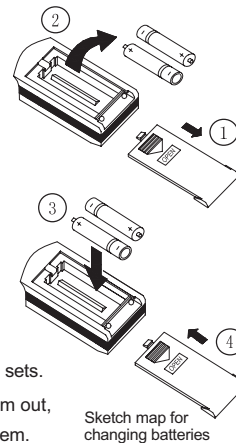

- When changing the batteries, do not use the old or different batteries, otherwise, it can cause the malfunction of the wireless remote control.
- If the wireless remote control will not be used for a long time, please take them out, and don't let the leakage liquid damage the wireless remote control.
- The operation should be in its receiving range.
- It should be placed at where is 1m away from the TV set or stereo sound sets.
- If the wireless remote control can not operate normally, please take them out, after 30s later and reinsert, if they cannot normally run, please change them.



## ◆ Emergency operation

### Displayer indicator light control of indoor unit

It's a special selective button for the users, who are not accustomed to the light at sleeping.

- Get the displayer indicator light on: When setting the light function, the mark  will display on the remote controller screen by pressing this button. In which case, the displayer indicator light will be on if the AC receives this signal.
- Get the displayer indicator light off: If cancel the light function, the mark  will disappear on the remote controller screen by pressing this button. In which case, the displayer indicator light will be off if the AC receives this signal.

### Emergency operation

If the wireless remote control is lost or broken, please use the manual switch button. At this time, the unit will run at the Auto mode, but the temperature and fan speed cannot be changed. The operation was shown as below:

To open the panel, the manual switch is on the displayer box.

- Turn on the unit: Press the button, the unit will run at Auto mode immediately. The microcomputer will accord to the indoor temperature to select (Cooling, Heating, Fan) and obtain the comfortable effect.
- Turn off the unit: Press the button, the unit will stop working.

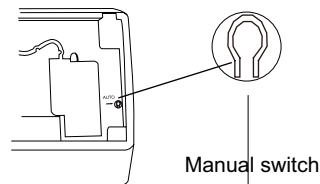

Fig.3

## ◆ Clean and care



### Caution

- Turn power off and pull out the power plug before cleaning air conditioner, or it may cause electric shock.
- Never sprinkle water on the indoor unit and the outdoor unit for cleaning because it can cause an electric shock.
- Volatile liquid (e.g. thinner or gasoline) will damage the air conditioner. (So wipe the units with a dry soft cloth, or a cloth slightly moistened with water or cleanser.)

#### Clean the front panel

When cleaning the front panel, please dip the cloth into the water temperature of 45°C below, then to dry the cloth and wipe the dirty part.

Note: Please do not to immerse the front panel in water, due to there are microcomputer components and circuit diagrams on the front panel.

#### Clean the air filter (Recommended once every three months)

NOTE: If dust is much more around the air conditioner, the air filters should be cleaned many times. After taking off the filter, don't touch the fin of indoor unit, in order to avoid hurt your fingers.

#### ① Take down the air filter

At the slot of surface panel to open an angle, pull the air filter downward and take it out, please see the Fig. 4(a, b).

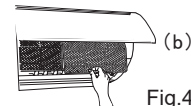
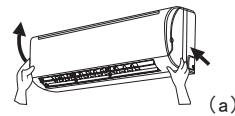
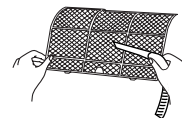

Fig.4

#### ② Clean the air filter

To clean the dust adhering to the filters, you can either use a vacuum cleaner, or wash them with warm water (the water with the neutral detergent should below 45 degree), and dry it in the shade.

NOTE: Never use water above 45°C to clean, or it can cause deformation or discoloration. Never parch it by fire, or can cause a fire or deformation.



#### ③ Insert the air filter

Reinsert the filters along the direction of arrowhead, and then to cover the cover and clasp it.

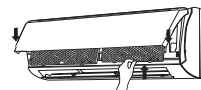

## ◆ Clean and care

### Check before use

- ① Be sure that nothing obstructs the air outlet and intake vents.
- ② Check that whether ground wire is properly connected or not.
- ③ Check that whether the batteries of air conditioner are changed or not.
- ④ Check that whether the installation stand of the outdoor unit is damaged or not. If damaged, please contact the dealer.

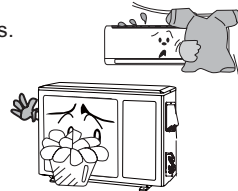

### Maintain after use

- ① Turn main power off.
- ② Clean the filter and indoor and outdoor units' bodies.
- ③ Clear dust and obstructions from the outdoor unit.
- ④ Repaint the rubiginous place on the outdoor unit to prevent it from spreading.
- ⑤ Adopt the special shield to cover the outdoor unit, avoid the rain water, dust enter into the unit and get rust.







## ◆ Troubleshooting

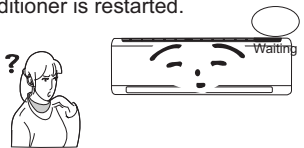

### CAUTION

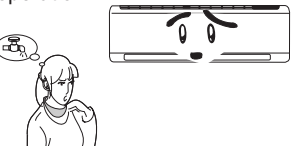
Don't attempt to repair the air conditioner by yourself, it can cause an electric shock or fire. Please check the following items before asking for repair, it can save your time and money.

Phenomenon	Troubleshooting
<p>Not operate immediately when the air conditioner is restarted.</p> 	<ul style="list-style-type: none"> <li>Once the air conditioner is stopped, it will not operate in approximately 3 minutes to protect itself.</li> </ul>
<p>There's unusual smell blowing from the outlet after operation is started.</p> 	<ul style="list-style-type: none"> <li>The unit has no peculiar smell by itself. If has, that is due to the smell accumulated in the ambient.</li> <li>Solution method: Cleaning the filter. If problem still has, so need to clean air conditioner. (Please contact with the authorized maintenance center.)</li> </ul>
<p>Sound of water flow can be heard during the operation.</p> 	<ul style="list-style-type: none"> <li>The air conditioner is started, when it is running the compressor started or stopped running, or the unit is stopped, sometimes there is swoosh or gurgle, the sound is due to refrigerant flowing they are not malfunctions.</li> </ul>
<p>In COOL mode, sometimes the mist emitted from the air outlet vent.</p> 	<ul style="list-style-type: none"> <li>When the indoor temperature and humidity are very high, this phenomenon would happen. This is caused by the room air is swiftly cooled down. After running for a while, indoor temperature and humidity will fall down, the mist will die away.</li> </ul>
<p>Creaking noise can be heard when start or stop the unit.</p> 	<ul style="list-style-type: none"> <li>This is caused by the expansion and contraction of plastic due to the changes of temperature.</li> </ul>

## ◆ Troubleshooting

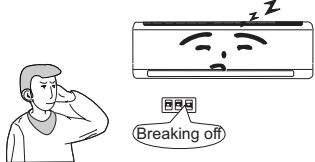
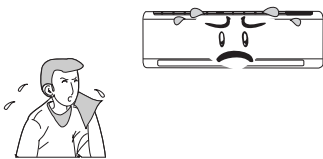
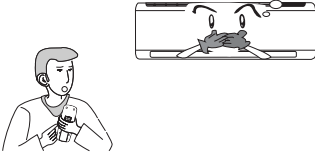
Phenomenon	Troubleshooting
<p>The unit can not run.</p> 	<ul style="list-style-type: none"> <li>● Has the power been shut down?</li> <li>● Is power plug loosed?</li> <li>● Is the circuit protection device tripped off or not?</li> <li>● Is voltage higher or lower? (Tested by professionals)</li> <li>● Is the TIMER correctly used?</li> </ul>
<p>Cooling(Heating) efficiency is not good.</p> 	<ul style="list-style-type: none"> <li>● Is Temp. setting suitable?</li> <li>● Were inlet and outlet vents obstructed?</li> <li>● Is filter dirty?</li> <li>● Are the windows and doors closed?</li> <li>● Did Fan speed set at low speed?</li> <li>● Is there any heat sources in the room?</li> </ul>
<p>Wireless remote control is not available.</p> 	<ul style="list-style-type: none"> <li>● The unit is interfered by abnormal or frequent functions switchover occasionally the controller cannot operate. At this time, you need to pull out of the plug, and reinsert it.</li> <li>● Is it in its receiving range? Or obstructed? To check the voltage in wireless remote control inside is charged, otherwise to replace the batteries.</li> <li>● Whether the wireless remote control is damaged.</li> </ul>
<p>If water leakage in the room.</p>	<ul style="list-style-type: none"> <li>● The air humidity is on the high side.</li> <li>● Condensing water over flowed.</li> <li>● The connection position of indoor unit drainage pipe is loosed.</li> </ul>
<p>If water leakage in outdoor unit.</p>	<ul style="list-style-type: none"> <li>● When the unit is running in COOL mode, the pipe and connection of pipe would be condensed due to the water cooled down.</li> <li>● When the unit is running in Auto Defrosting mode the ice thawed and flowed out.</li> <li>● When the unit is running in HEAT mode, the water adhered on heat exchanger dripped off.</li> </ul>
<p>Noise from indoor unit emitted.</p>	<ul style="list-style-type: none"> <li>● The sound of fan or compressor relay is switching on or off.</li> <li>● When the defrosting is started or stop running, it will sound. That is due to the refrigerant flowed to the reverse direction.</li> </ul>

## ◆ Troubleshooting

Phenomenon	Troubleshooting
Indoor unit cannot deliver air.	<ul style="list-style-type: none"> <li>● In HEAT mode, when the temperature of indoor heat exchanger is very low, that will stop deliver air in order to prevent cool air. (Within 2min)</li> <li>● In HEAT mode, when the outdoor temperature is low or high humidity, there are much frost be formed on the outdoor heat exchanger, that the unit will automatically defrost, indoor unit stop blowing air for 3-12min. During the defrosting, there is water flowing out or vapor be produced.</li> <li>● In dehumidifying mode, sometimes indoor fan will stop, in order to avoid condensing water be vaporized again, restrain temperature rising.</li> </ul>
Moisture on air outlet vent.	<ul style="list-style-type: none"> <li>● If unit is running under the high humidity for a long time, the moisture will be condensed on the air outlet grill and drip off.</li> </ul>
	
<b>Immediately stop all operations and plug out, contact the dealer in following situations.</b>	
<p>There is harsh sound during operation.</p> <p>The terrible odors emitted during operation.</p> <p>Water is leaking in the room.</p> <p>Air switch or protection switch often breaks.</p> <p>Careless splash water or something into unit.</p> <p>There is an abnormal heat in power supply cord and power plug.</p>	<p>▶ Stop running and pull out of the plug.</p>

## ◆ Installation Manual



### Important Notices

1. The unit installation work must be done by qualified professional individual according to the local codes and this manual.
2. When relocating the unit to the other place, please contact with the qualified professional individual in the local area.

### Basic Requirements For Installation Position

Install in the following place may cause malfunction. If it is unavoidable contact with service center please:

- Place where strong heat sources, vapors, flammable gas or volatile object are emitted.
- Place where high-frequency waves are generated by radio equipment, welders and medical equipment.
- Place where a lot of salinities such as coast exists.
- Place where the oil (machine oil) is contained in the air.
- Place where a sulfured gas such as the hot spring zones is generated.
- Other place with special circumstance.

### Indoor Unit Installation Position Selection

1. The air inlet and outlet vent should be far from the obstruction, make sure that the air can be circulated through the whole room.
2. Select a position where the condensate can be easily drained out, and the place is easily connected for outdoor unit.
3. Select a location where the children can not reach.
4. Can select the place strong enough to withstand the full weight and vibration of the unit. And will not increase the noise.
5. Be sure to leave enough space to allow access for routine maintenance. The height of the installed location should be 98.42 in or more from the floor.
6. Select a place about 39.37 in or more away from TVset or any other electric appliances.
7. Select a place where the filter can be easily taken out.
8. Make sure that the indoor unit installation should accord with installation dimension diagram requirements.
9. Do not use the unit in the immediate surroundings of a laundry, bath, shower or a swimming pool.

### Outdoor Unit Installation Position Selection

1. Select a location from which noise and outflow air emitted by unit will not be inconvenience to neighbors, animals, plants.
2. Select a location where there should be sufficient ventilation.
3. Select a location where there should be no obstructions cover the inlet and outlet vent.
4. The location should be able to withstand the full weight and vibration of the outdoor unit and permit safe installation.
5. Select a dry place, but do not expose under the direct sunlight or strong wind.
6. Make sure that the outdoor unit installation dimension should accord with installation dimension diagram, convenient for maintenance, repair.
7. The height difference of connecting the tubing within 196.85 in, the length of connecting the tubing within 393.70 in.
8. Select a place where it is out of reach for the children.
9. Select a place where will not block the passage and do not influence the city appearance.

## ◆ Installation Manual

### Safety Requirements For Electric Appliances

1. The power supply should be used the rated voltage and AC exclusive circuit, the power cable diameter should be satisfied.
2. Don't drag the power cable emphatically.
3. It should be reliably grounded, and it should be connected to the special ground device, the installation should be performed by a professional.  
The air switch must have the functions of magnetic tripping and heat tripping, in order to protect the short circuit and overloading.
4. The min. distance from the unit and combustive surface is 59.05 in.
5. The appliance shall be installed in accordance with national wiring regulations.
6. An all-pole disconnection switch having a contact separation of at least 0.12 in in all poles should be connected in fixed wiring.

### Ground requirements

1. Air conditioner is type I electric appliance, thus please do conduct reliable ground measure.
2. The yellow-green two-color wire in air conditioner is ground wire and cannot be used for other propose. It cannot be cut off and be fix it by screw, otherwise it would cause electric shock.
3. The earth resistance should accord to the National Criterion.
4. The user power must offer the reliable earthing terminal. Please don't connect the earthing wire with the following place:
  - ① Tap water pipe.
  - ② Gas pipe.
  - ③ Contamination pipe.
  - ④ Other places that professional personnel consider them unreliable.
5. The model and rating values for fuses according the silk print on fuse cover or related PCB board.

◆ Installation dimension diagram

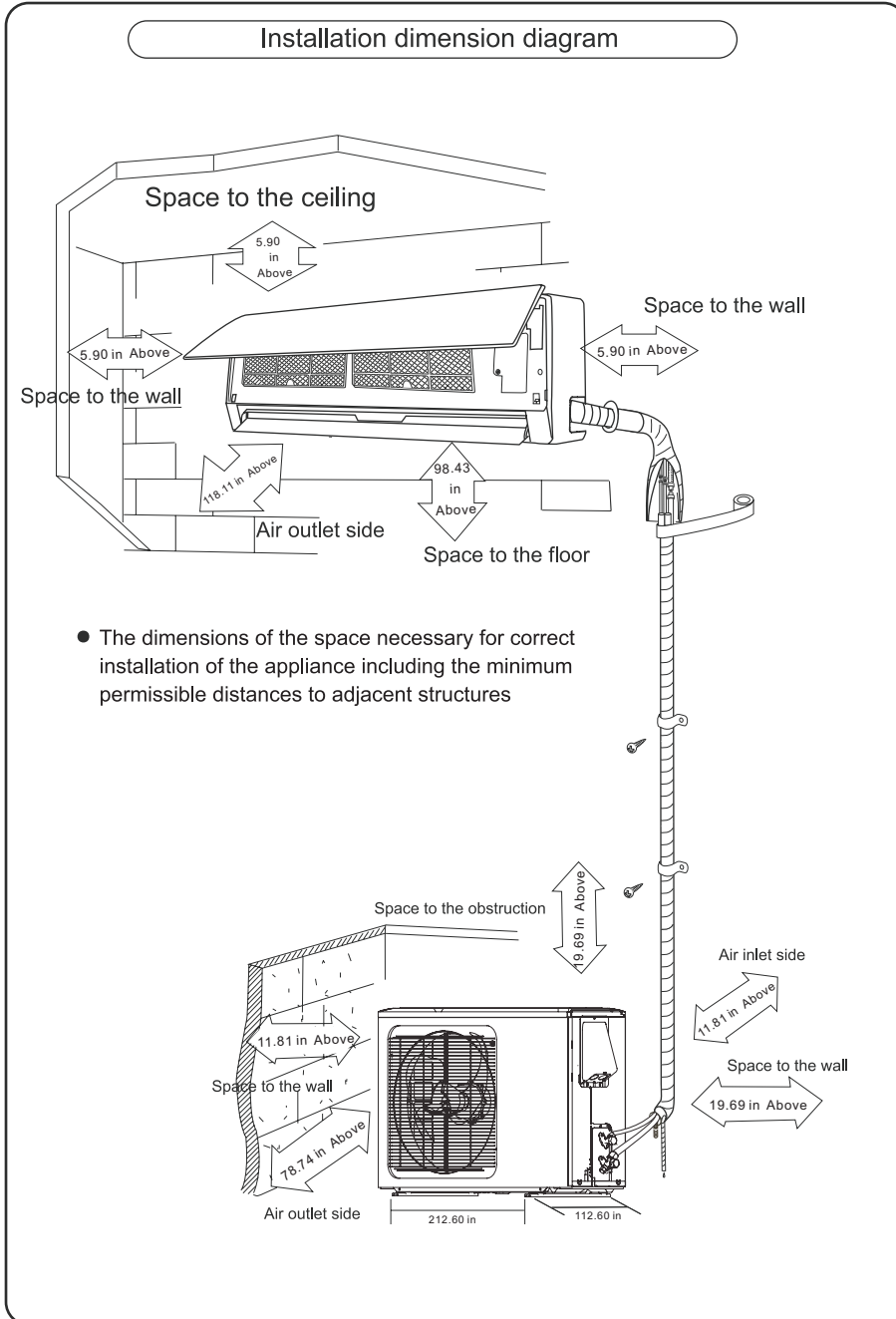

## ◆ Install indoor unit

### Install the rear panel

1. Always mount the rear panel horizontally. Due to the water tray of indoor unit has been adopted the both-way drainage design, the outlet of water tray should be adjusted slightly down when installing, that is taking the outlet of the water tray as the center of a circle, the included angle between the evaporator and level should be 0 or more, that is good for condensing water drainage.

2. Fix the rear panel on the wall with screws. (Where is pre-covered with plastic granula)  
3. Be sure that the rear panel has been fixed firmly enough to withstand the weight of an adult of 60kg, further more, the weight should be evenly shared by each screw.

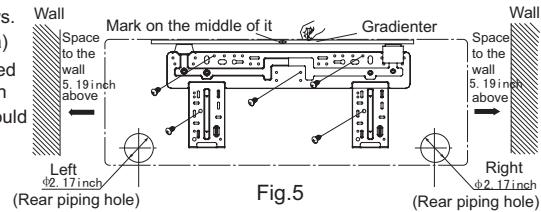
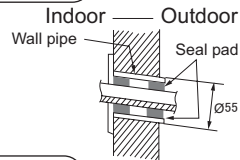

Fig.5

### Install the piping hole

1. Make the piping hole ( $\phi 2.17$  in) in the wall at a slight downward slant to the outdoor side.  
2. Insert the piping-hole sleeve into the hole to prevent the connection piping and wiring from being damaged when passing through the hole.



### Install the water drainage pipe

1. For good draining, the drain hose should be placed at a downward slant.  
2. Do not wrench or bend the drain hose or flood its end by water.  
3. When the long drainage hose passing through indoor, should wrap it with insulation materials.

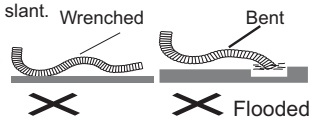

### Connect indoor and outdoor electric wires

1. Open the surface panel.  
2. Remove the wiring cover Fig 6.  
3. Route the power connection cord and signal control wire (for cooling and heating unit only) from the back of the indoor unit and pull it toward the front through the wiring hole for connection.  
4. Reassemble the clamp and wiring cover.  
5. Recover the surface panel.

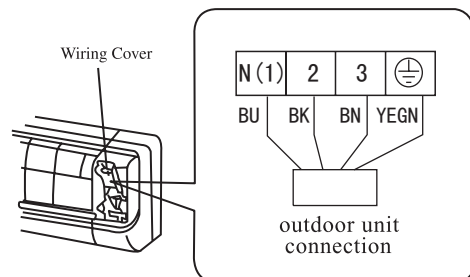

Fig.6

## ◆ Install indoor unit

### NOTE:

When connecting the electric wire if the wire length is not enough, please contact with the authorized service shop to buy a exclusive electric wire that is long enough and the joint on the wire are not allowed.

- The electric wiring must be correctly connected, wrong connection may cause spare parts malfunction.
- Tighten the terminal screw in order to prevent loose.
- After tighten the screw, slight pull the wire and confirm whether is it firm or not.
- If the earth wire is wrong connection, that may cause electric shock.
- The cover plate must be fixed, and tighten the connection wire, if it is poor installed, that the dust, moisture may enter in or the connection terminal will be affected by outside force, and will cause fire or electric shock.

### Install the indoor unit

- The piping can be lead out from right, right rear, left left rear.
1. When routing the piping and wiring from the left or right side of indoor unit, cut off the tailings from the chassis in necessary(Show in Fig.7)
    - (1) Cut off the tailings 1 when routing the wiring only;
    - (2) Cut off the tailings 1 and tailings 2 when routing both the wiring and piping.
  2. Take out the piping from body case, wrap the piping electric wire, water pipe with tape and pull them through the piping hole (As show in Fig.8)
  3. Hange the mounting slots of the indoor unit on the upper tabs of the rear panel and check if it is firm enough.(As show in Fig.9)
  4. The height of the installed location should be 98.43 inch or more from the floor.
  5. The water drainage pipe can also be installed on the left of the indoor-uint.

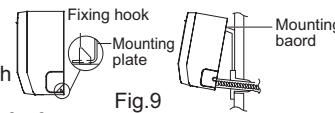
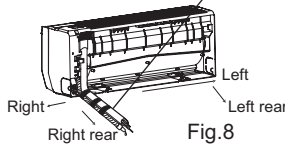
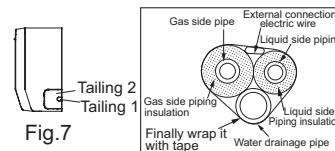

### Install the connection pipe

1. Align the center of the piping flare with the relevant valve.
2. Screw in the flare nut by hand and then tighten the nut with spanner and torque wrench refer to the following:

Hex nut diamete	Tightening torque(ft. lb)
Φ0.24in	11.06~14.75
Φ0.37in	22.86~25.81
Φ0.47 in	36.88~40.56
Φ0.63in	44.25~47.94
Φ0.75in	51.63~55.31

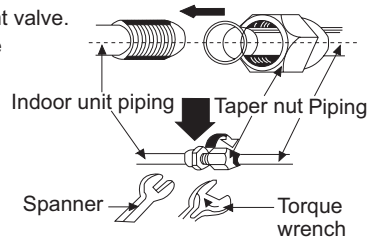

NOTE: Firstly connect the connection pipe to indoor unit, then to outdoor unit; pay attention to the piping bending, do not damage the connection pipe; the joint nut couldn't tighten too much, otherwise it may cause leakage.



## ◆ Install outdoor unit

### Electric wiring

1. Disassemble the cable cross plate sub-assy on the outdoor unit right side plate.
2. Take off wire clamp. Connect and fix power connect cord (for cooling and heating unit, connect and fix power connect cord and signal control wire) to terminal of line bank. Wiring should fit that of indoor unit.
3. Fix the power connection cable with wire clamp, (for cooling and heating unit, use the wire clamp to fix the power connection cable and the signal control wire), then connect the corresponding connector.
4. Ensure wire has been fixed well.
5. Install the cable cross plate sub-assy.

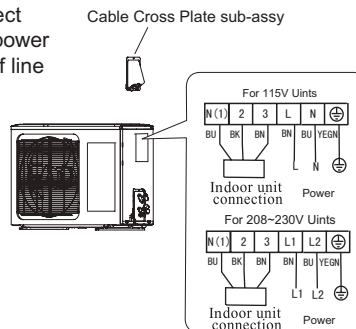

#### NOTE:

- Wrong wiring may cause spare parts malfunction.
- After the cable fixed, make sure there should be a free space between the connection and connection and fixing place on the lead wire.

### Air purging and leakage test

1. Connect charging hose of manifold valve to charge end of low pressure valve (both high/low pressure valves must be tightly shut).
2. Connect joint of charging hose to vacuum pump.
3. Fully open handle handle of Lo manifold valve.
4. Open the vacuum pump to evacuate. At the beginning, slightly loosen joint nut of low pressure valve to check if there is air coming inside. (If noise of vacuum pump has been changed, the reading of multimeter is 0) Then tighten the nut.
5. Keep evacuating for more than 15mins and make sure the reading of multi-meter is  $-1.0 \times 10^5 \text{pa}$  ( $-29.92 \text{inchHg}$ ).
6. Fully open high/low pressure valves.
7. Remove charging hose from charging end of low pressure valve.
8. Tighten bonnet of low-pressure valve. (As shown in Fig.10)

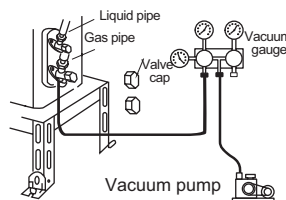
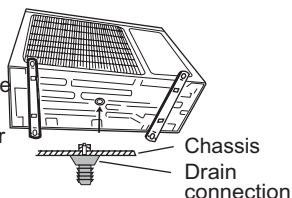

Fig. 10

### Condensate drainage of outdoor unit (Heat pump model)

The condensate and defrosting water formed during heating in the outdoor unit can be properly discharged by drainage pipe.

Installation method: set the drain connection in  $\varnothing 0.98$  inch hole of the chassis has been installed and then connect drainage pipe with drain nozzle, so that condensate and defrosting water can be properly discharged



◆ Check after installation and test operation

Check after installation

Items to be checked	Possible malfunction
Has it been fixed firmly?	The unit may drop, shake or emit noise.
Have you done the refrigerant leakage test?	It may cause insufficient cooling(heating) capacity
Is heat insulation sufficient?	It may cause condensation and dripping.
Is water drainage well?	It may cause condensation and dripping.
Is the voltage in accordance with the rated voltage marked on the nameplate?	It may cause electric malfunction or damage the part.
Is the electric wiring and piping connection installed correctly and securely?	It may cause electric malfunction or damage the part.
Has the unit been connected to a secure earth connection?	It may cause electrical leakage.
Is the power cord specified?	It may cause electric malfunction or damage the part.
Is the inlet and outlet been covered?	It may cause insufficient cooling(heating) capacity.
Has the length of connection pipes and refrigerant capacity been recorded?	The refrigerant capacity is not accurate.

Test Operation

1. Before test operation

- (1) Do not switch on power before installation is finished completely.
- (2) Electric wiring must be connected correctly and securely.
- (3) Cut-off valves of the connection pipes should be opened.
- (4) All the impurities such as scraps and thrums must be cleared from the unit.

2. Test operation method

- (1) Switch on power, press "ON/OFF" button on the wireless remote control to start the operation.
- (2) Press MODE button, to select the COOL, HEAT (Cooling only unit is not available), FAN to check whether the operation is normal or not.

## ◆ Installation and Maintenance of Healthy Filter

### Installation Instructions

1. Forcibly pull the panel for a specific angle from the two ends of the front panel according to the arrow direction. Then pull the air filter downwards to remove it. (See Fig.a)

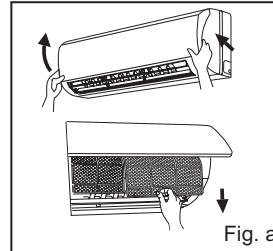

2. Mount the healthy filter onto the air filter, (as shown in Fig.b). If the air filter cannot be installed, please mount the healthy filter on the front case. (as shown in Fig.c)

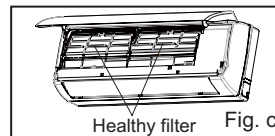
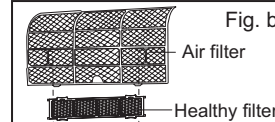

3. Mount the air filter properly along the arrow direction in Fig.d, and then close the panel cover.

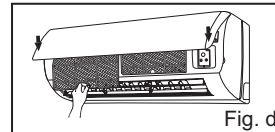

### Cleaning and Maintenance

Take out the healthy filter before cleaning and reinstall it after cleaning according to the installation instruction. Pay special attention to that silver ion filter can't be cleaned with water, while active carbon, photocatalyst, low temperature conversion (LTC) catalyst, formaldehyde eliminator, catechin or mite killing filter can, but can't with brush or hard things. Dry it in the shade or sun after cleaning, but not by wiping.

### Service Life

The healthy filter commonly has its usage lifetime for one year under normal condition. As for silver ion filter, it is invalid when its surface becomes black (green).

- This supplementary instruction is provided for reference to the unit with healthy filter. If the graphics provided herein is different from the physical goods, the latter one shall prevail. The quantity of healthy filters shall be based on the actual delivery.

# Schematic Diagram

## • Indoor Unit QSVSI-09A QSVSI-12A

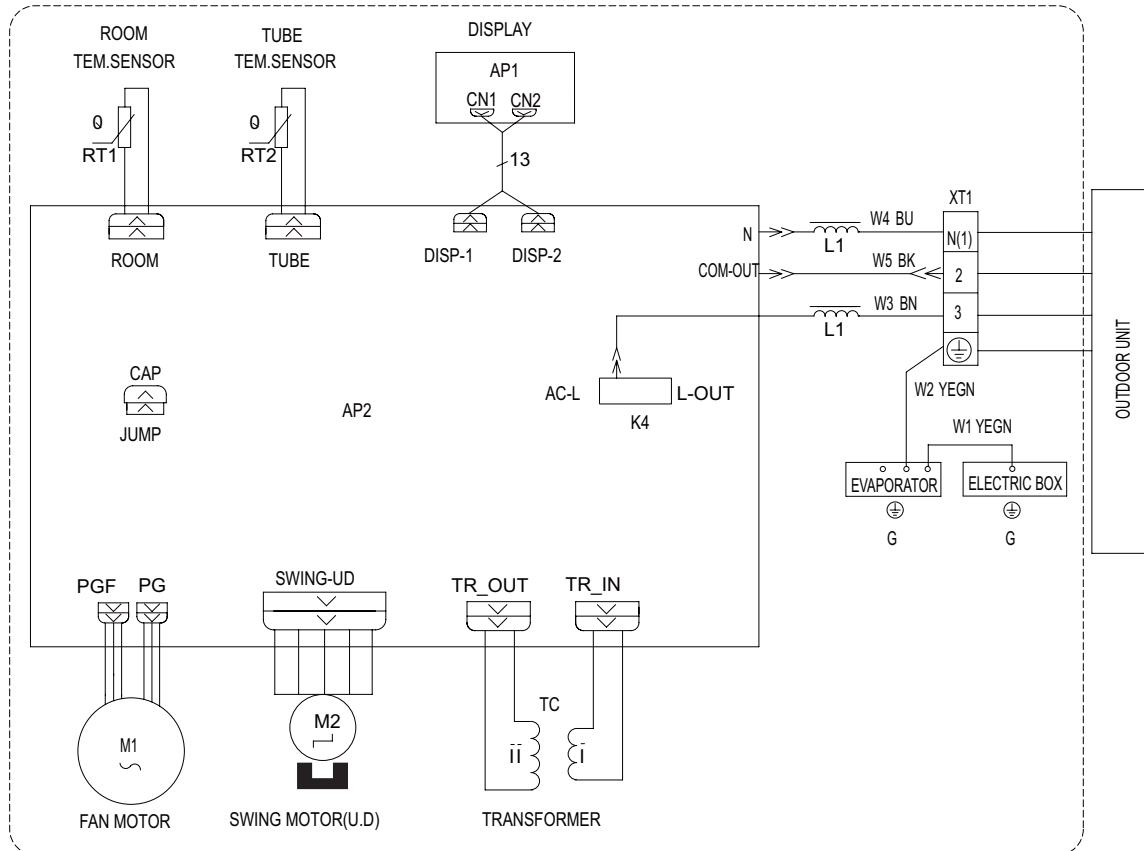

● Outdoor Unit QSVSO-09A QSVSO-12A

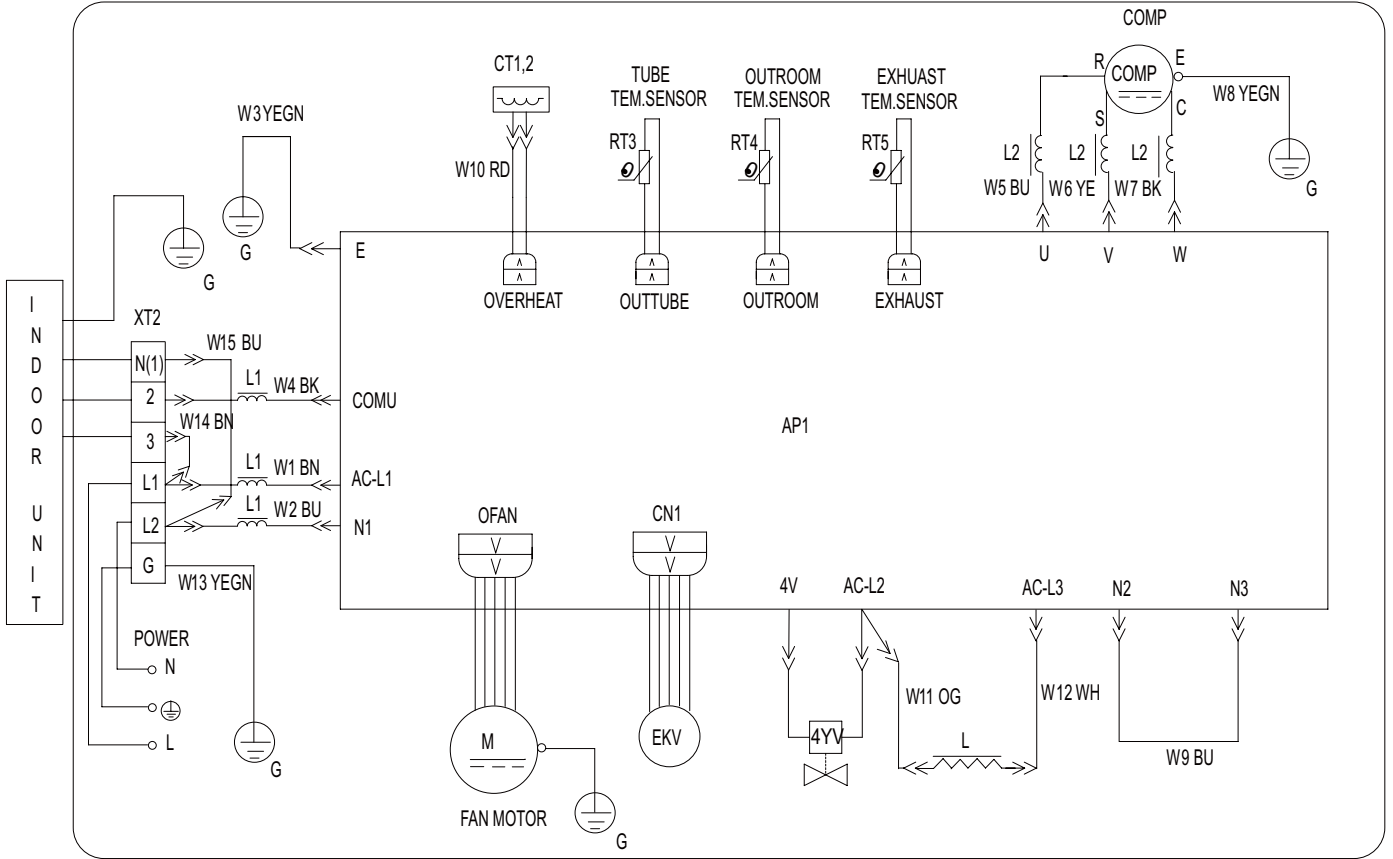

**QUIETSIDe CORPORATION**

**[www.quietside.com](http://www.quietside.com)**

West Office

8750 Pioneer Blvd.

Santa Fe Springs, CA 90670 USA

Phone: 562-699-6066

Fax: 562-699-4351

East Office

6 Pine Hill Drive

Carlisle, PA 17013

Phone: 886-243-6498/ 717-243-2535

Fax: 717-243-7917

TX Office

3001 Northern Cross Blvd. Suite 361

Fort Worth, TX 76137

Phone: 817-838-6066

Fax: 817-838-8670

66129907431

**QUIETSIDe**  
