



# Contents

---

Safety precautions.....	2
Deciding on where to install the air conditioner.....	4
Air conditioner and accessories.....	10
Installing and connecting the drain hose of the outdoor unit.....	11
Cutting/extending the piping.....	11
Connecting the cables to the outdoor unit.....	12
Transmitter installation (optional).....	15
Checking correct earthing.....	17
Fixing the unit in position.....	17
Connecting up and purging the circuit.....	18
Adding refrigerant.....	19
Performing leak tests.....	20
Pipe installation with indoor units.....	20
Setting an indoor unit address and installation option.....	21
Troubleshooting.....	30
Explaining operations to the owner.....	32
Pump down procedure (when removing the product).....	33

# Safety precautions

---

Carefully follow the precautions listed below because they are essential to guarantee the safety of the equipment.



## WARNING

- Always disconnect the air conditioner from the power supply before servicing it or accessing its internal components.
- Verify that installation and testing operations are performed by qualified personnel.
- Verify that the air conditioner is not installed in an easily accessible area.

---

## GENERAL INFORMATION

- ◆ Carefully read the content of this manual before installing the air conditioner and store the manual in a safe place in order to be able to use it as reference after installation.
- ◆ For maximum safety, installers should always carefully read the following warnings.
- ◆ Store the operation and installation manual in a safe location and remember to hand it over to the new owner if the air conditioner is sold or transferred.
- ◆ This manual explains how to install an indoor unit with a split system with two SAMSUNG units. The use of other types of units with different control systems may damage the units and invalidate the warranty. The manufacturer shall not be responsible for damages arising from the use of non compliant units.
- ◆ The manufacturer shall not be responsible for damage originating from unauthorized changes or the improper connection of electric and hydraulic lines. Failure to comply with these instructions or to comply with the requirements set forth in the "Operating limits" table, included in the manual, shall immediately invalidate the warranty.
- ◆ The air conditioner should be used only for the applications for which it has been designed: the indoor unit is not suitable to be installed in areas used for laundry.
- ◆ Do not use the units if damaged. If problems occur, switch the unit off and disconnect it from the power supply.
- ◆ In order to prevent electric shocks, fires or injuries, always stop the unit, disable the protection switch and contact SAMSUNG's technical support if the unit produces smoke, if the power cable is hot or damaged or if the unit is very noisy.
- ◆ Always remember to inspect the unit, electric connections, refrigerant tubes and protections regularly. These operations should be performed by qualified personnel only.
- ◆ The unit contains moving parts, which should always be kept out of the reach of children.
- ◆ Do not attempt to repair, move, alter or reinstall the unit. If performed by unauthorized personnel, these operations may cause electric shocks or fires.
- ◆ Do not place containers with liquids or other objects on the unit.

- 
- ◆ All the materials used for the manufacture and packaging of the air conditioner are recyclable.
  - ◆ The packing material and exhaust batteries of the remote control(optional) must be disposed of in accordance with current laws.
  - ◆ The air conditioner contains a refrigerant that has to be disposed of as special waste. At the end of its life cycle, the air conditioner must be disposed of in authorized centers or returned to the retailer so that it can be disposed of correctly and safely.
  - ◆ The appliance is not intended for use by persons (including children) with reduced physical, sensory or mental capabilities, or lack of experience and knowledge, unless they have been given supervision or instruction concerning use of the appliance by a person responsible for their safety: Young children should be supervised to ensure that they do not play with the appliance.

#### INSTALLING THE UNIT

---

**IMPORTANT:** When installing the unit, always remember to connect first the refrigerant tubes, then the electrical lines.

Always disassemble the electric lines before the refrigerant tubes.

- ◆ Upon receipt, inspect the product to verify that it has not been damaged during transport. If the product appears damaged, DO NOT INSTALL it and immediately report the damage to the carrier or retailer (if the installer or the authorized technician has collected the material from the retailer.)
- ◆ After completing the installation, always carry out a functional test and provide the instructions on how to operate the air conditioner to the user.
- ◆ Do not use the air conditioner in environments with hazardous substances or close to equipment that release free flames to avoid the occurrence of fires, explosions or injuries.
- ◆ To prevent injury when accidentally touching the indoor unit fan, install the indoor unit at least 2.5m above the floor.
- ◆ The air conditioner should be used only for the applications for which it has been designed: the indoor unit is not suitable to be installed in areas used for laundry.
- ◆ Our units must be installed in compliance with the spaces indicated in the installation manual to ensure either accessibility from both sides or ability to perform routine maintenance and repairs. The units' components must be accessible and that can be disassembled in conditions of complete safety either for people or things. For this reason, where it is not observed as indicated into the Installation Manual, the cost necessary to reach and repair the unit (in safety, as required by current regulations in force) with slings, trucks, scaffolding or any other means of elevation won't be considered in-warranty and charged to end user.

#### POWER SUPPLY LINE, FUSE OR CIRCUIT BREAKER

---

- ◆ Always make sure that the power supply is compliant with current safety standards. Always install the air conditioner in compliance with current local safety standards.
- ◆ Always verify that a suitable grounding connection is available.
- ◆ Verify that the voltage and frequency of the power supply comply with the specifications and that the installed power is sufficient to ensure the operation of any other domestic appliance connected to the same electric lines.
- ◆ Always verify that the cut-off and protection switches are suitably dimensioned.
- ◆ Verify that the air conditioner is connected to the power supply in accordance with the instructions provided in the wiring diagram included in the manual.
- ◆ Always verify that electric connections (cable entry, section of leads, protections...) are compliant with the electric specifications and with the instructions provided in the wiring scheme. Always verify that all connections comply with the standards applicable to the installation of air conditioners.

# Deciding on Where to Install the Air Conditioner

---

When deciding on the location of the air conditioner with the owner, the following restrictions must be taken into account.

## General

Do NOT install the air conditioner in a location where it will come into contact with the following elements:

- ◆ Combustible gases
- ◆ Saline air
- ◆ Machine oil
- ◆ Sulphide gas
- ◆ Special environmental conditions
- ◆ The air conditioner should be used only for the applications for which it has been designed : the indoor unit is not suit able to be installed in areas used for laundry. If you must install the unit in such conditions, first consult your dealer.

## Outdoor Unit

- ◆ The outdoor unit must NEVER be placed on its side or upside down, as the compressor lubrication oil will run into the cooling circuit and seriously damage the unit.
- ◆ Choose a location that is dry and sunny, but not exposed to direct sunlight or strong winds.
- ◆ Do not block any passageways or thoroughfares.
- ◆ Choose a location where the noise of the air conditioner when running and the discharged air do not disturb any neighbours.
- ◆ Choose a position that enables the piping and cables to be easily connected to the indoor unit and the recommended length will be respected.
- ◆ Install the outdoor unit on a flat, stable surface that can support its weight and does not generate any unnecessary noise and vibration.
- ◆ Position the outdoor unit so that the air flow is directed towards the outside, as indicated by the arrows on the top of the unit.
- ◆ Maintain sufficient clearance around the outdoor unit, as indicated in the diagram on the page opposite.
- ◆ Make sure that the water dripping from the drain hose runs away correctly and safely.
- ◆ When installing the outdoor unit near seashore, make sure it is not directly exposed to sea breeze. If you can not find a adequate place without direct see breeze, protection wall should be constructed.

- ◆ Install the outdoor unit in a place (such as near buildings etc.) where it can be prevented from sea breeze which can damage the outdoor unit.

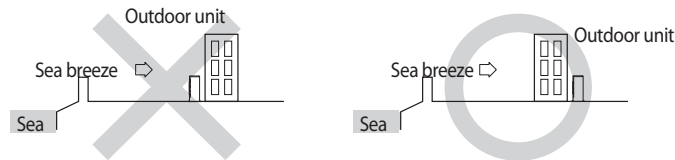

- ◆ If you cannot avoid installing the outdoor unit by the seashore, construct a protection wall around to block the sea breeze.

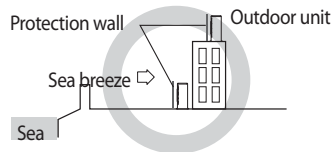

- Protection wall should be constructed with a solid material such as concrete to block the sea breeze and the height and the width of the wall should be 1.5 times larger than the size of the outdoor unit. Also, secure over 700mm between the protection wall and the outdoor unit for exhausted air to ventilate.

- ◆ Install the outdoor unit in a place where water can drain smoothly.

\* If you cannot find a place satisfying above conditions, please contact manufacturer. Make sure to clean the sea water and the dust on the outdoor unit heat exchanger and spread corrosion inhibitor on heat exchanger. (At least one time per one year.)



CAUTION

- ◆ You have just purchased a Free Joint Multi air conditioner and it has been installed by your installation specialist.
- ◆ This device must be installed according to the national electrical rules.
- ◆ Max input power & current is measured according to IEC standard and input power & current is measured according to ISO standard.
- ◆ More than 2 indoor units should be installed when you use Free Joint Multi air conditioner.
- ◆ Our units must be installed in compliance with the spaces indicated in the installation manual to ensure either accessibility from both sides or ability to perform routine maintenance and repairs.  
The units' components must be accessible and that can be disassembled in conditions of complete safety either for people or things. For this reason, where it is not observed as indicated into the Installation Manual, the cost necessary to reach and repair the unit (in safety, as required by current regulations in force) with slings, trucks, scaffolding or any other means of elevation won't be considered in-warranty and charged to end user.
- ◆ With an outdoor unit having net weight upper then 60kg, we suggest do not install it suspended on wall, but considering floor standing one.
- ◆ When the outdoor unit is installed near seashore or in a place where sulfuric acid gas may leak, corrosion may occur in outdoor unit and cause product malfunction.

# Deciding on Where to Install the Air Conditioner

## ◆ AJ020CJ2CH

Indoor unit	Outdoor unit	Power supply $\phi$ , V, Hz
**007/009/012**	AJ020CJ2CH	1,208-230,60

## ◆ Piping outside diameter

Unit	Outside diameter	
	Liquid	Gas
**007/009/012**	1/4"	3/8"

※ AJ020CJ2CH Outdoor unit cannot be connected to the following indoor unit combination.  
- \*\*018/024\*\*



CAUTION

3 m as minimum pipe length: It will reduce noise and vibration.

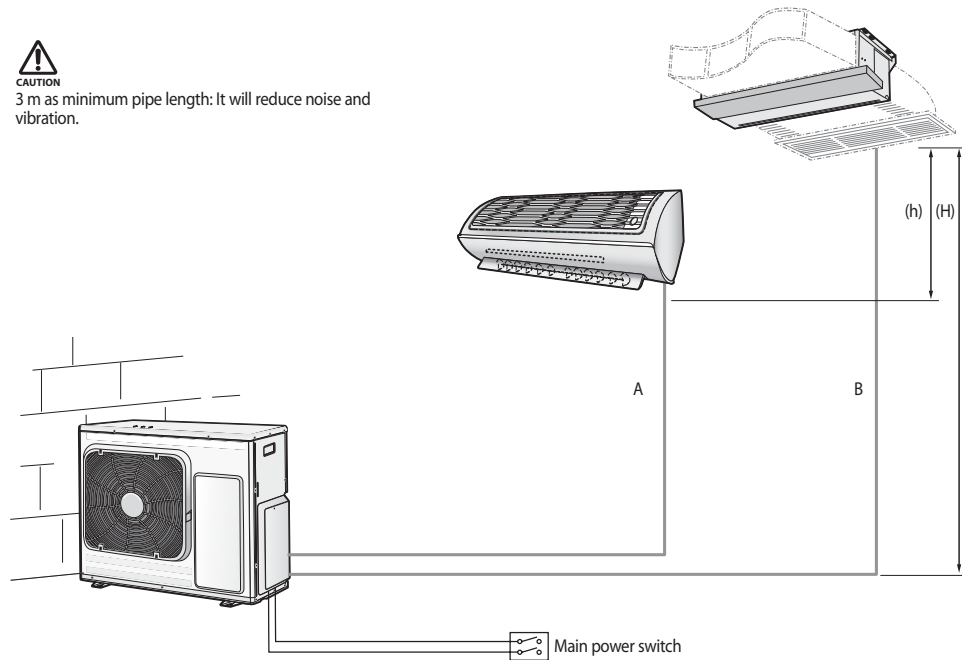

The appearance of the unit may be different from the diagram depending on the model.

## ◆ Piping length and the height

	1 Room max length	2 Room total max length	Max height between indoor unit & outdoor unit	Max height between indoor units
Dimension	25 m(82 ft)	50 m(164 ft)	15 m(49 ft)	7.5 m(25 ft)
Composition	A,B	A+B	(H)	(h)

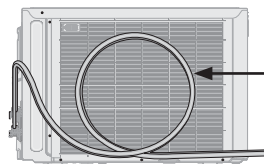

The appearance of the unit may be different from the diagram depending on the model.

◆ AJ024JCJ3CH

Indoor unit	Outdoor unit	Power supply $\phi$ , V, Hz
**007/009/012/018**	AJ024JCJ3CH	1,208-230,60

◆ Piping outside diameter

Unit	Outside diameter	
	Liquid	Gas
**007/009/012**	1/4"	3/8"
**018**	1/4"	1/2"

※ AJ024JCJ3CH Outdoor unit cannot be connected to the following indoor unit combination.  
- \*\*024\*\*

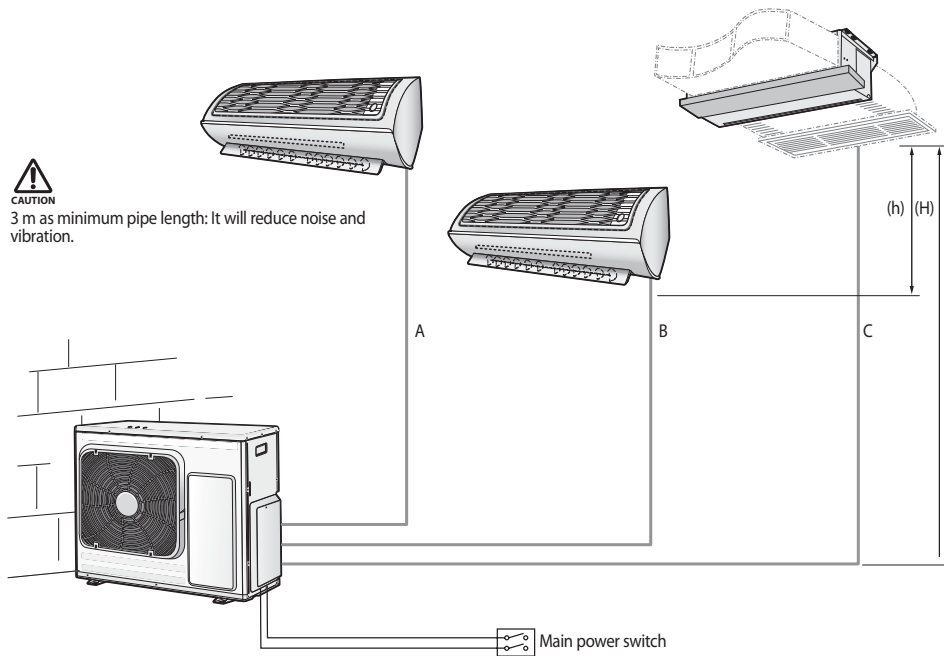

The appearance of the unit may be different from the diagram depending on the model.

◆ Piping length and the height

	1 Room max length	3 Room total max length	Max height between indoor unit & outdoor unit	Max height between indoor units
Dimension	25 m(82 ft)	70 m(230 ft)	15 m(49 ft)	7.5 m(25 ft)
Composition	A,B,C	A+B+C	(H)	(h)

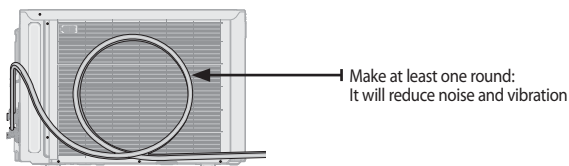

The appearance of the unit may be different from the diagram depending on the model.

# Deciding on Where to Install the Air Conditioner

## Space Requirements for Outdoor Unit

When installing 1 outdoor unit

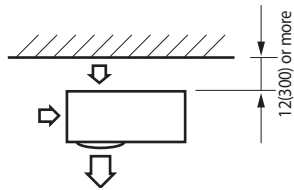

Unit : inch (mm)

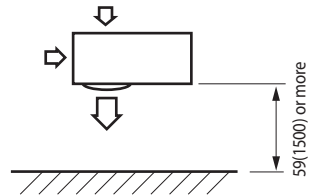

When the air outlet is opposite the wall

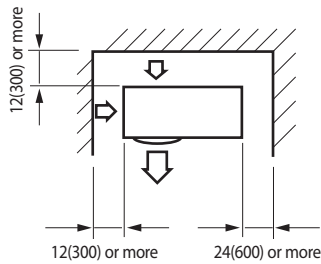

When the air outlet is towards the wall

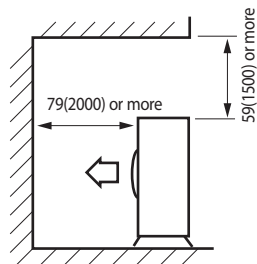

When 3 sides of the outdoor unit are blocked by the wall

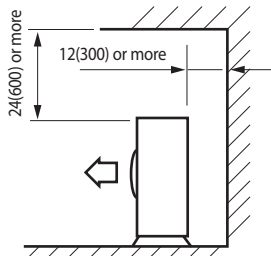

The upper part of the outdoor unit and the air outlet is towards the wall

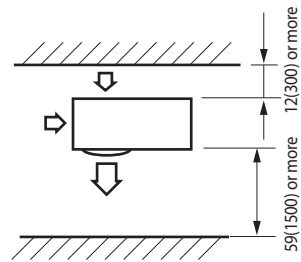

The upper part of the outdoor unit and the air outlet is opposite the wall

When front and rear side of the outdoor unit is towards the wall

When installing more than 1 outdoor unit

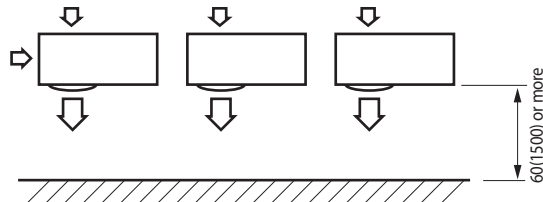

When the air outlet is towards the wall



When installing more than 1 outdoor unit

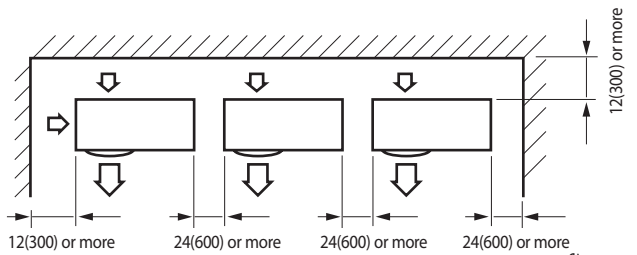

When 3 sides of the outdoor unit are blocked by the wall

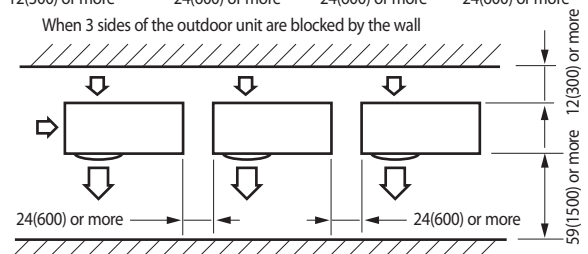

When front and rear side of the outdoor unit is towards the wall

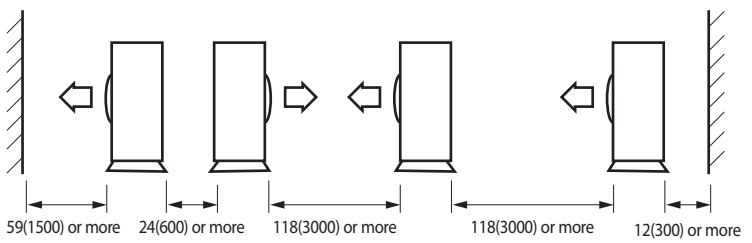

When front and rear side of the outdoor unit is towards the wall

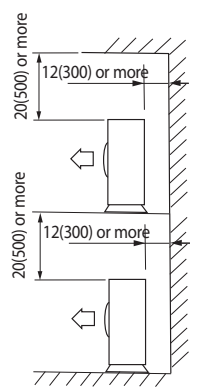







The upper part of the outdoor unit and the air outlet is opposite the wall

# Air conditioner and accessories

The following accessories are supplied with the air conditioner.









## Accessories in the Outdoor Unit Case

### ◆ AJ020JCJ2CH

3-wire Power Cable (option) 	2-wire Assembly Cable (option) 	Drain Plug 	Energy Label 	Rubber Leg 	Installation Manual 
---	--	---	---	---	--

Attach Energy Label to the outdoor unit properly when installing.

### ◆ AJ024JCJ3CH

3-wire Power Cable (option) 	2-wire Assembly Cable (option) 	Drain Plug 	Installation Manual 
Rubber Leg 	Flare Nuts, 9.52mm outer pipe diameter 	Flare Bolt (Nut 12.70mm; Bolt 9.52mm) 	Energy Label 

Attach Energy Label to the outdoor unit properly when installing.

- The 3-wire power cable and the 2-wire assembly cable are optional. If these cables are not supplied, use the standard cable approved by IEC standard. Please, check "Connecting the Cables to the Outdoor Unit" section.

## Installing and connecting the drain hose of the outdoor unit

While heating, ice may accumulate. During the process of defrosting, check if condensation draining is adequate. For adequate draining, do the following:

1. Insert the drain plug into the drain hole on the underside of the outdoor unit.
2. Connect the drain hose to the drain plug.
3. Ensure that condensation draining is adequate.

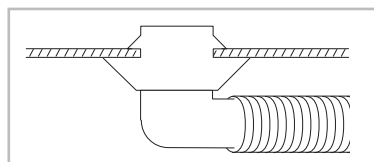
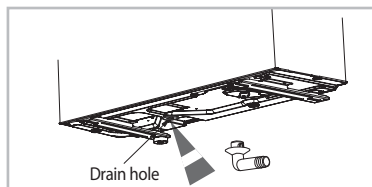

## Cutting/extending the piping

1. Make sure that you have the required tools available (pipe cutter, reamer, flaring tool and pipe holder).
2. If you wish to shorten the piping, cut it using a pipe cutter, taking care to ensure that the cut edge remains at a 90° angle with the side of the pipe, and referring to the illustrations below for examples of edges cut correctly and incorrectly.

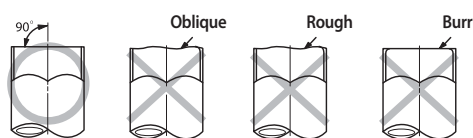
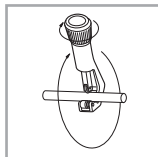

3. To prevent any gas from leaking out, remove all burrs at the cut end of the pipe, using a reamer.
4. Slide a flare nut on to the pipe and modify the flare.

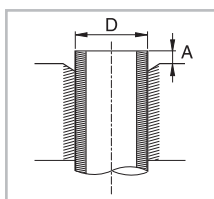

Outer Diameter (D)	Thickness	Depth (A)
ø6.35 mm(1/4")	0.8 mm(0.03 inch)	1.3 mm(0.05 inch)
ø9.52 mm(3/8")	0.8 mm(0.03 inch)	1.8 mm(0.07 inch)
ø12.70 mm(1/2")	0.8 mm(0.03 inch)	2.0 mm(0.08 inch)
ø15.88 mm(5/8")	0.8 mm(0.03 inch)	2.2 mm(0.09 inch)

5. Check that the flaring is correct, referring to the illustrations below for examples of incorrect flaring.

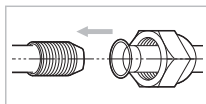

6. Align the pipes to be connected and tighten the flare nuts first manually and then with a torque wrench, applying the following torque.

Outer Diameter (D)	Thickness	Torque	
		N·m	ft·lb(kgf·cm)
ø6.35 mm(1/4")	0.8 mm(0.03 ")	14~18	10.1~13.0(140~180)
ø9.52 mm(3/8")	0.8 mm(0.03 ")	34~42	25.3~31.1(350~430)
ø12.70 mm(1/2")	0.8 mm(0.03 ")	49~61	36.2~44.8(500~620)
ø15.88 mm(5/8")	0.8 mm(0.03 ")	68~82	49.9~60.0(690~830)

7. For further details on how to connect up to the outdoor unit and purge the circuit, refer to page 20.

➤ In case welding the pipe, the gas nitrogen must be blown into the parts.

# Connecting the cables to the outdoor unit

## Selecting compressed ring terminal

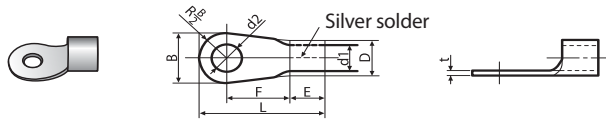

Normal dimensions for cable [mm <sup>2</sup> (inch <sup>2</sup> )]	Normal dimensions for screw [mm(inch)]	B		D		d1		E	F	L	d2		t
		Standard dimension [mm(inch)]	Allowance [mm(inch)]	Standard dimension [mm(inch)]	Allowance [mm(inch)]	Standard dimension [mm(inch)]	Allowance [mm(inch)]				Min.	Min.	
1.5(0.002)	4(0.16)	6.6(0.26)	±0.2 (±0.008)	3.4(0.13)	+0.3(+0.011) -0.2(-0.008)	1.7(0.07)	±0.2 (±0.008)	4.1 (0.16)	6 (0.24)	16 (0.63)	4.3(0.17)	+0.2(+0.008) 0(0)	0.7 (0.028)
	4(0.16)	8(0.31)											
2.5(0.004)	4(0.16)	6.6(0.26)	±0.2 (±0.008)	4.2(0.17)	+0.3(+0.011) -0.2(-0.008)	2.3(0.09)	±0.2 (±0.008)	6 (0.24)	6 (0.24)	17.5 (0.69)	4.3(0.17)	+0.2(+0.008) 0(0)	0.8 (0.031)
	4(0.16)	8.5(0.33)											
4(0.006)	4(0.16)	9.5(0.37)	±0.2 (±0.008)	5.6(0.22)	+0.3(+0.011) -0.2(-0.008)	3.4(0.13)	±0.2 (±0.008)	6 (0.24)	5 (0.20)	20 (0.79)	4.3(0.17)	+0.2(+0.008) 0(0)	0.9 (0.035)



- In case of extending the electric wire, please DO NOT use a round-shaped pressing socket.
- Incomplete wire connections can cause electric shock or a fire.

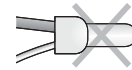

◆ AJ020JCJ2CH

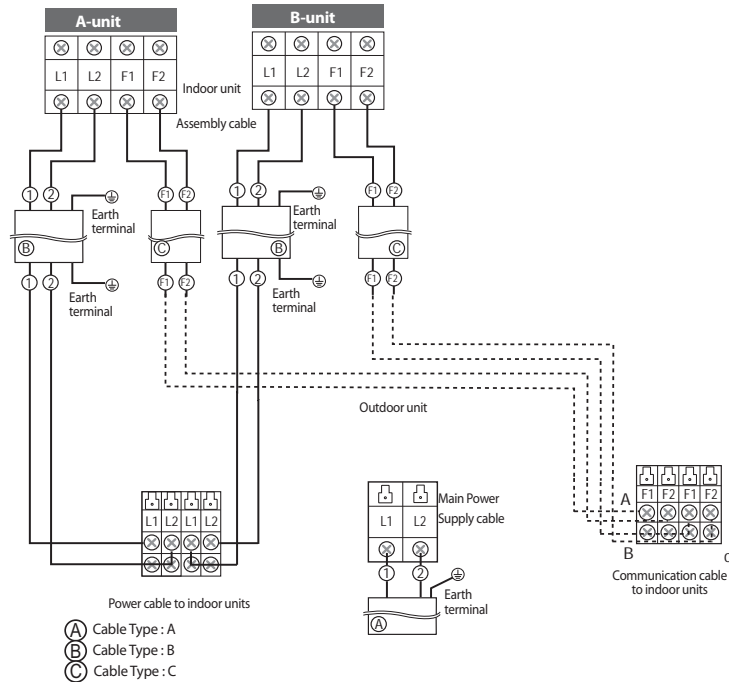

**Specification for circuit breaker and power supply cord**

- » Power supply cord is not supplied with air conditioner.
- » Select the power supply cord in accordance with relevant local and national regulations.
- » Wire size must comply with the applicable local and national code.
- » Specifications for local wiring power supply cord and branch wiring are in compliance with local code.
- » Power Supply cords of parts of appliances for outdoor use shall not be lighter than polychloroprene sheathed flexible cord. (Code designation IEC:60245 IEC 57 / CENELEC: H05RN-F, IEC:60245 IEC 66 / CENELEC: H07RN-F)

**The specification for cables :**

Model	Main Power Supply Cable		Indoor Power Supply Cable		Communication Cable		FUSE	MCCB	Type GL
	Specication	Type	Specication	Type	Specication	Type			
AJ020JCJ2CH	3G, 2.5mm <sup>2</sup> (0.004inch <sup>2</sup> ) or more, H07RN-F	(A)	3G, 1.0mm <sup>2</sup> (0.002inch <sup>2</sup> ) or more, H07RN-F	(B)	2G, 0.75mm <sup>2</sup> (0.001inch <sup>2</sup> ) or more, H07RN-F	(C)	16.6A	Frame : 20A Trip : 16.6A	16.6A

- » Connect the power cable to the auxiliary circuit breaker. If every pole fails to connect to the power supply, it must be incorporated in a wire with a contact opening of ≥0.12 inch.

**Tightening power terminal**

- » Connect the cables to the terminal board using the compressed ring terminal.
- » Use rated cables only.
- » Connect the cables with driver and wrench that can apply the rated torque to the screws.
- » Make sure that appropriate tightening torque is applied for cable connection. If the terminal is loose, arc heat may occur and cause fire and if the terminal is connected too firmly, terminal may get damaged.

Screw	Tighten Torque ft-lb(kgf-cm)	Position
M4	0.87~1.08(12.0~15.0)	L1,L2,F1,F2

# Connecting the cables to the outdoor unit

◆ AJ024JCJ3CH

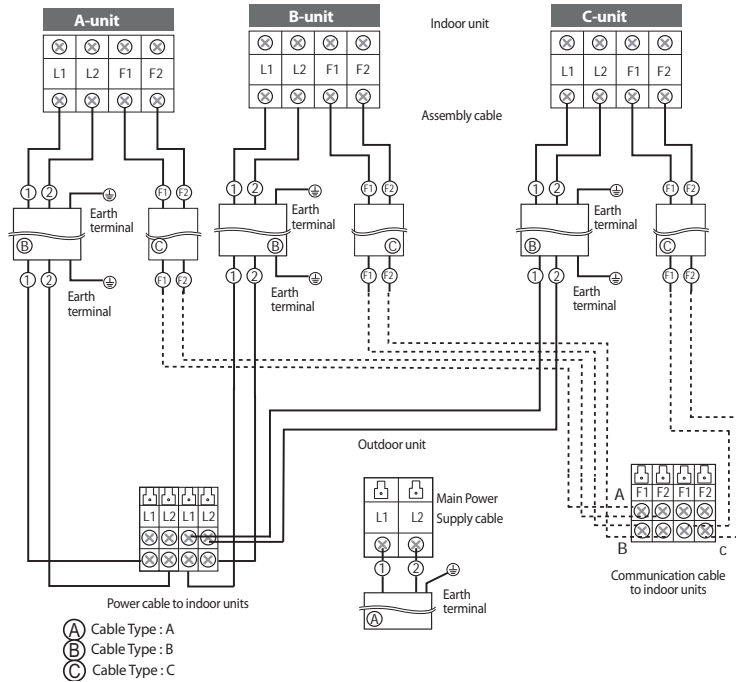

## Specification for circuit breaker and power supply cord

- Power supply cord is not supplied with air conditioner.
- Select the power supply cord in accordance with relevant local and national regulations.
- Wire size must comply with the applicable local and national code.
- Specifications for local wiring power supply cord and branch wiring are in compliance with local code.
- Power Supply cords of parts of appliances for outdoor use shall not be lighter than polychloroprene sheathed flexible cord. (Code designation IEC:60245 IEC 57 / CENELEC: H05RN-F, IEC:60245 IEC 66 / CENELEC: H07RN-F)

## The specification for cables :

Model	Main Power Supply Cable		Indoor Power Supply Cable		Communication Cable		FUSE	MCCB	Type GL
	Specication	Type	Specication	Type	Specication	Type			
AJ024JCJ3CH	3G, 2.5mm <sup>2</sup> (0.004inch <sup>2</sup> ) or more, H07RN-F	(A)	3G, 1.0mm <sup>2</sup> (0.002inch <sup>2</sup> ) or more, H07RN-F	(B)	2G, 0.75mm <sup>2</sup> (0.001inch <sup>2</sup> ) or more, H07RN-F	(C)	18A	Frame : 30A Trip : 18A	18A

- Connect the power cable to the auxiliary circuit breaker. If every pole fails to connect to the power supply, it must be incorporated in a wire with a contact opening of  $\geq 0.12$  inch.









## Tightening power terminal

- Connect the cables to the terminal board using the compressed ring terminal.
- Use rated cables only.
- Connect the cables with driver and wrench that can apply the rated torque to the screws.
- Make sure that appropriate tightening torque is applied for cable connection. If the terminal is loose, arc heat may occur and cause fire and if the terminal is connected too firmly, terminal may get damaged.

Screw	Tighten Torque ft-lb(kgf-cm)	Position
M4	0.87~1.08(12.0~15.0)	L1,L2,F1,F2

## Transmitter installation(optional)

### Accessories (Transmitter: MIM-B13A)

Transmitter MAIN 	Transmitter SUB 	485 Communication Cable 	DC Power Cable (12V) 	DC Power Cable (5V) 	Communication Cable 	Cable Tie 	Case 
---	--	--	---	--	---	--	---

1. Turn the power off and take off the cover of the outdoor units.
2. Fix the case with bolts to the side of the control box referring to the figure on the right side.  
In case of FJM outdoor unit, there is not enough space to fix all parts of transmitter. So you may use transmitter main PCB.
3. Attach the transmitter main PCB to the case, then connect F1/ F2 lines, R1/R2 lines which are upper controller communication cables and DC 12V power cables to the interface module referring to the figure on page 16. (Upper controller power should be off.)
4. You must check the position of dip switch on the transmitter's main PCB and the main PCB of indoor units.
5. Assemble a cover of the outdoor unit and turn the power on.
6. Check the communication status.
7. If you install a transmitter to the outdoor unit, every indoor unit which is connected to the outdoor unit can be controlled simultaneously.
8. Each outdoor unit connected to the same centralized controller has its own transmitter.

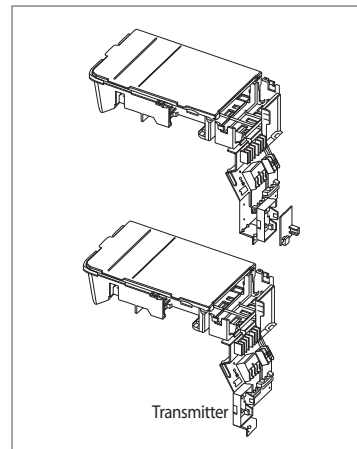

Fix the case with hinges  
(Control Box in the outdoor unit)

# Transmitter installation(optional)

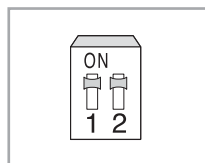
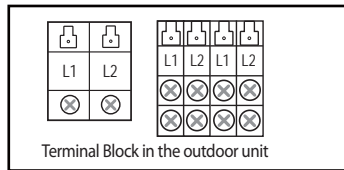
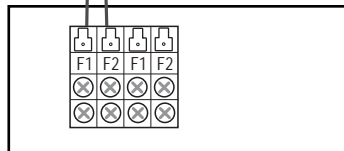
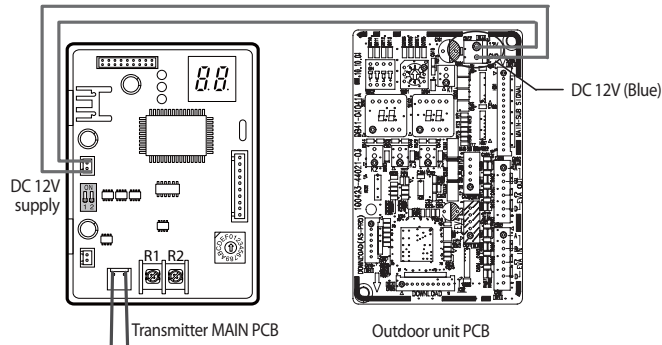

Check the dip switch position on transmitter main PCB as the picture above, "turn ON"

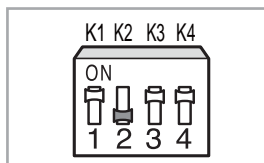

Change DIP switch-K2 on indoor units PCB (K2 : ON OFF).



## Checking correct earthing

If the power distribution circuit does not have an earth or the earth does not comply with specifications, an earthing electrode must be installed. The corresponding accessories are not supplied with the air conditioner.

1. Select an earthing electrode that complies with the specifications given in the illustration opposite.
2. Determine a suitable location for the earthing electrode:
  - ◆ In damp hard soil rather than loose sandy or gravel soil that has a higher earthing resistance.
  - ◆ Away from underground structures or facilities, such as gas pipes, water pipes, telephone lines and underground cables.
  - ◆ At least two meters away from a lightening conductor earthing electrode and its cable.

➤ The earthing wire for the telephone line cannot be used to earth the air conditioner.
3. Dig a hole of the size indicated in the illustration opposite, drive the earthing electrode into position and cover the top of the electrode with the excavated soil.
4. Install a green/yellow insulated earthing wire (Ø0.06inch(1.6 mm), section 0.003inch<sup>2</sup>(2 mm<sup>2</sup>) or greater):
  - ◆ If the earthing wire is too short, connect an extension lead, soldering the connection and wrapping it with insulating tape (do not bury the soldered connection)
  - ◆ Secure the earthing wire in position with staples If the earthing electrode is installed in an area of heavy traffic, its wire must be connected securely
5. Carefully check the installation, by measuring the earthing resistance with an earthing resistance tester. If the resistance is above the required level(Example:100Ω), drive the earthing electrode deeper into the ground or increase the number of earthing electrodes.
6. Connect the earthing wire to the earthing screw on the air conditioner.

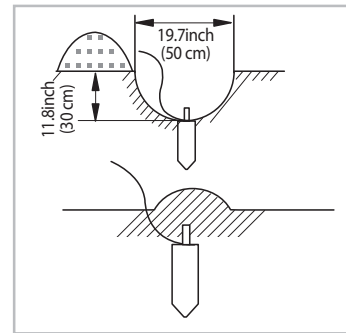
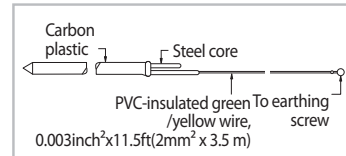

ENGLISH

## Fixing the unit in position

The outdoor unit must be installed on a rigid and stable base to avoid any increase in the noise level and vibration, particularly if the outdoor unit is to be installed close to a neighbour.

If it is to be installed in a location exposed to strong winds or at a height, the unit must be fixed to an appropriate support (wall or ground).

1. Position the outdoor unit so that the air flow is directed towards the outside, as indicated by the arrows on the top of the unit.
  2. Attach the outdoor unit to the appropriate support using anchor bolts.
    - ◆ The earthing wire for the telephone line cannot be used to earth the air conditioner.
  3. If the outdoor unit is exposed to strong winds, install shield plates around the outdoor unit, so that the fan can operate correctly.
- Certainly fix up its rubber leg in order to prevent its vibration and noise.

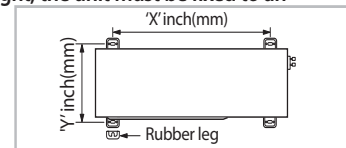

Model	X	Y
AJ020JCJ2CH / AJ024JCJ3CH	26.0(660)	13.4(340)

### OUTDOOR UNIT INSTALLED ON THE WALL BY RACK

- Ensure the wall will be able to suspend the weight of rack and outdoor unit;
- Install the rack close to the column as much as possible;
- Install proper grommet in order to reduce noise and residual vibration transferred by outdoor unit towards wall.

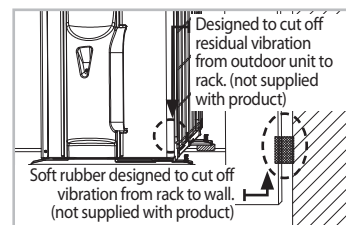

## Connecting up and purging the circuit



When installing, make sure there is no leakage. When recovering the refrigerant, ground the compressor first before removing the connection pipe. If the refrigerant pipe is not properly connected and the compressor works with the service valve open, the pipe inhales the air and it makes the pressure inside of the refrigerant cycle abnormally high. It may cause explosion and injury.

You should purge the air in the indoor unit and in the pipe.

If air remains in the refrigerant pipes, it affects the compressor. It may cause reduction of cooling capacity and malfunction. Refrigerant for air purging is not charged in the outdoor unit. Use Vacuum Pump as seen in the picture.

- 1 Check the piping connections.
- 2 Connect the charging hose of low pressure side of manifold gauge to the packed valve having a service port (5/8" Packed valve) as shown at the figure (Valve stem: 1/2" - 20UNF).



◆ Make the electrical connection and leave the system into "stand by mode". Do not turn on the system! This is necessary for better vacuum operation (full OPEN position of Electronic Expansion Valve - EEV -).

- 3 Open the valve of the low pressure side of manifold gauge counter clockwise.
- 4 Purge the air from the system using vacuum pump for about 30 minutes.
  - Close the valve of the low pressure side of manifold gauge clockwise.
  - Make sure that pressure gauge show -0.1MPa(-76cmHg) after about 30 minutes. This procedure is very important in order to avoid gas leak.
  - Turn off the vacuum pump.
  - Remove the hose of the low pressure side of manifold gauge.
- 5 Set valve cork of both liquid side and gas side of packed valve to the open position.
- 6 Mount the valve stem nuts and the service port cap to the valve, and tighten them at the torque of 13.2ft·lb(183kgf·cm) with a torque wrench.
- 7 Check for gas leakage.
  - At this time, especially check for gas leakage from the 3-way valve's stem nuts, and from the service port cap.

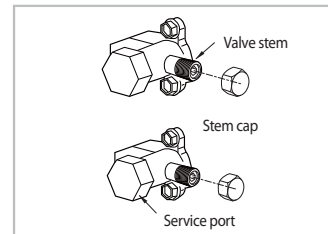
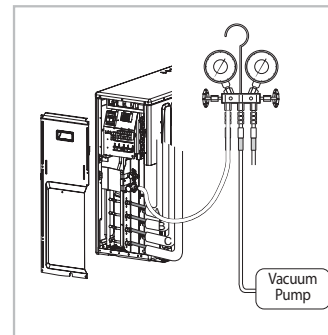

# Adding refrigerant

If you install the excessive length of pipe, add additional refrigerant as 0.02lbs(10g)[0.044lbs(20g)] per unit meter ; refer to the table below.

Refer to the Service Manual for more details on this operation.

Model	Total connecting pipe length (L)	Adding refrigerant
AJ020JCJ2CH	LT≤98.4ft(30m)	Chargeless
	LT>98.4ft(30m)	(LT- 98.4ft(30m))x0.02lbs(10g)
AJ024JCJ3CH	LT≤131.2ft(40m)	Chargeless
	LT>131.2ft(40m)	(LT- 131.2ft(40m))x0.02lbs(10g)

## Charging the refrigerant under conditions of liquid by using a liquid pipe

R-410A is a mixed type of refrigerant. It is necessary for recharging under conditions of liquid. When recharging refrigerant from the refrigerant cylinder to the equipment, follow the instructions below.

1. Before recharging, check whether the cylinder has a siphon or not.  
There are two ways to recharge the refrigerant.

Cylinder with siphon

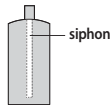

◆ Charge the refrigerant standing the cylinder upright.

Cylinder without siphon



◆ Charge the refrigerant turning the cylinder upside down.



NOTE

- If R-410A refrigerant is charged with gas, the composition of the charged refrigerant changes and the characteristics of the equipment vary.
- During the measuring operation of refrigerant quantity added use an electronic balance.  
If cylinder doesn't have syphon, upset it.

## Performing leak tests

Before completing the installation (insulation of the cables, hose and piping and fixing of the indoor unit to the installation plate), you must check that there are no gas leaks.

### LEAK TEST WITH NITROGEN (before opening valves)

In order to detect basic refrigerant leaks, before recreating the vacuum and recirculating the R-410A, it's responsible of installer to pressurize the whole system with nitrogen (using a cylinder with pressure reducer) at a pressure above 40 bar (gauge).

### LEAK TEST WITH R-410A (after opening valves)

Before opening valves, discharge all the nitrogen into the system and create vacuum according to page 13.

After opening valves, check leaks using a leak detector for refrigerant.

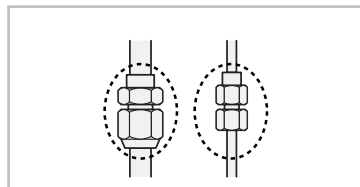

### PUMP DOWN (before disconnecting the refrigerant connections for unit repair, removal or disposal)

Pump-down is an operation intended to collect all the system refrigerant in the outdoor unit. This operation must be carried out before disconnecting the refrigerant pipe in order to avoid refrigerant loss to the atmosphere.

- Shut off all the liquid valve with the Allen wrench.
- Turn the system on in cooling with fan operating at high velocity. (Compressor will immediately start, provided 3 minutes have elapsed since the last stop).
- After 2 minutes of operation, shut down the suction valves with the same wrench.
- Turn the system off and switch mains supply off.
- Disconnect pipes. After disconnection, protect valves and tubing ends from dust.
- Compressor damage may occur if run at a negative suction pressure.

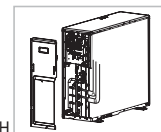

AJ020JCJ2CH

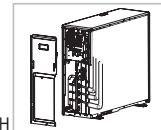

AJ024JCJ3CH

The designs and shape are subject to change according to the model.

## Pipe installation with indoor units

Follow different orders depending on the capacity of indoor units.

### ◆ AJ020JCJ2CH

<\*\*\*007/009/012\*\*\*>

- ▶ Install pipes between indoor and outdoor units orderly as [ A B ].

### ◆ AJ024JCJ3CH

<\*\*\*007/009/012\*\*\*>

- ▶ Install pipes between indoor and outdoor units orderly as [ A B C ].

<\*\*\*018\*\*\*>

- ▶ Install pipes between indoor and outdoor units orderly as [ C ].

Port	Indoor unit
A	***007/009/012***
B	***007/009/012*** <sup>1)</sup>
C	***018***

1) Use tube connector (pipe 12.70 mm(1/2 inch), bolt 9.52 mm(3/8 inch))

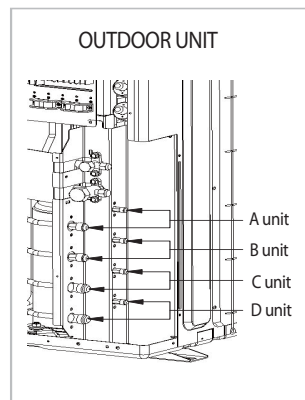

The designs and shape are subject to change according to the model.

## Setting an indoor unit address and installation option



This product is prohibited one indoor unit installation. Don't use pipe checking operation and Auto Addressing Mode when one indoor unit is installed.

- ◆ Switch the system on and wait for code "E 99" to appear on the display of the external unit (this requires approximately 60 seconds\*\*).
- ◆ As soon as code "E 99" displays, press once the red button (K1) shown on the figure on the side of the page:



If the quantity of indoor units connected is lower than maximum connectable to outdoor unit, the rotary switch SW01 has to be positioned, in order to select a number equal to indoor units' quantity you connected.

- ◆ After the operations described above have been performed, the system starts in Cooling or Heating mode, depending on the external ambient temperature. After a few minutes (from a minimum of 3 to 5 minutes for the internal unit), the system stops automatically, completing the self-test and addressing procedure.  
"E 99" appears on the display of the external unit.
- ◆ 20 seconds after the display of "E 99" (that confirms the correct execution of the procedure), the following codes (if four internal units are connected) display in sequence on the display of the external unit:

Display 1	Display 2	Description
00	00	The outdoor unit is communication correctly together the indoor unit connected to refrigerant pipe A.
01	00	The outdoor unit is communication correctly together the indoor unit connected to refrigerant pipe B.
02	00	The outdoor unit is communication correctly together the indoor unit connected to refrigerant pipe C.
03	00	The outdoor unit is communication correctly together the indoor unit connected to refrigerant pipe D.

At this point it is possible to start the internal units in the desired mode

- If "E 99" doesn't display, the procedure has failed and it is therefore necessary to read ALL the operator's manual before repeating the operating described in steps 1-2-3-4.

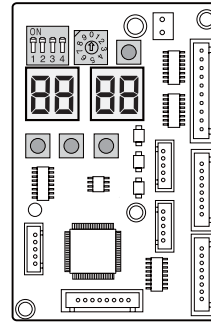

Display of the external unit

During the initial 60 seconds, display 1 shows in sequence:  
00 01 02 ...15 00...

# Setting an indoor unit address and installation option

- Step 1** Review all the following elements in the installation:
- ◆ Installation site strength
  - ◆ Piping connection tightness to detect any gas leakage
  - ◆ Connection wiring
  - ◆ Heat-resistant insulation of the piping
  - ◆ Drainage
  - ◆ Earthing wire connection

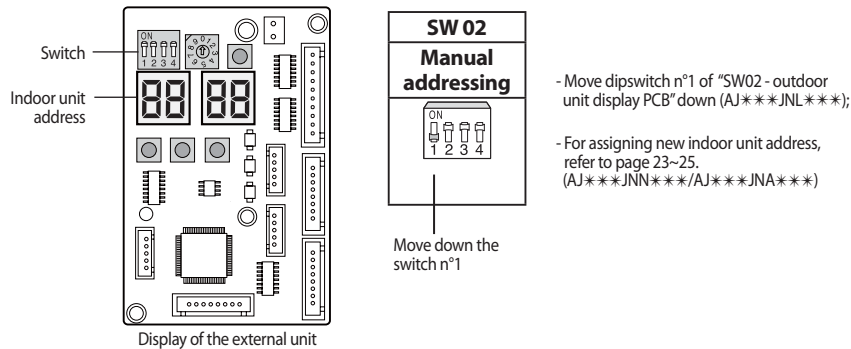

- Step 2** **IMPORTANT!**  
Before selecting switch turn off the system power supply  
Advise control we are going to proceed with manual addressing as follow:



- Step 3** Follow of indication reported into table below for indoor unit addressing

- Step 4** Turn on the system power supply and waiting for 60 seconds after establishing communication between outdoor and indoor units.  
During this phase, the left display of outdoor unit display PCB "DIS01" will count from 00-01-02 to 15.  
Established communication the left display will count sequentially:  
00--communication with indoor unit A;  
01--communication with indoor unit B;  
02--communication with indoor unit C;  
03--communication with indoor unit D;

In case of Manual address mode, you can do pipe check operation for check whether you connect the pipes correctly or not. But you need set indoor address switch yourselves.

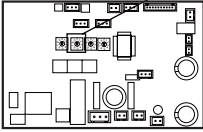
TYPE	PICTURE	MODEL	TO SET ADDRESSING MANUALLY BY ROTARY SWITCH "SW02"
SLIM DUCT		AJ009JNLDCH AJ012JNLDCH AJ018JNLDCH	 <p>Same for:</p> 

**ROTARY SWITCH "SW02" POSITION ACCORDING TO REFRIGERANT CIRCUIT CONNECTED ( 0=A; 1=B; 2=C; 3=D )**

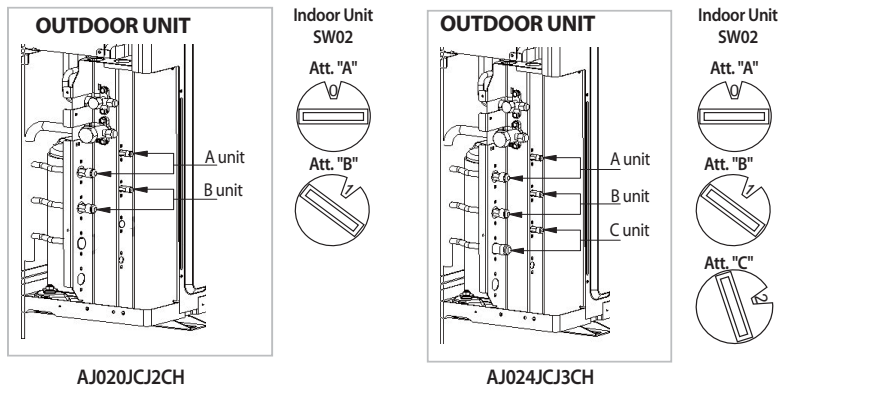

**INSTALLATION TEST MODE (with all indoor units functioning)**

Please do cool mode try-run or heat mode try run.  
Cool mode try-run : Push the [K2] button three times.  
Heat mode try-run : Push the [K2] button once.

After 12 minutes of stationary condition check each indoor unit air treatment:  
Cooling mode (indoor unit check) -> Inlet air temp. - Outlet air temp: From 10°K to 12°K ( indicative delta T)  
Heating mode (indoor unit check) -> Outlet air temp. - Inlet air temp: From 11°K to 14°K (indicative delta T)  
In heating mode, the indoor fan motor can remain off to avoid cold air blown into conditioned space.

# Setting an indoor unit address and installation option

## Setting Option

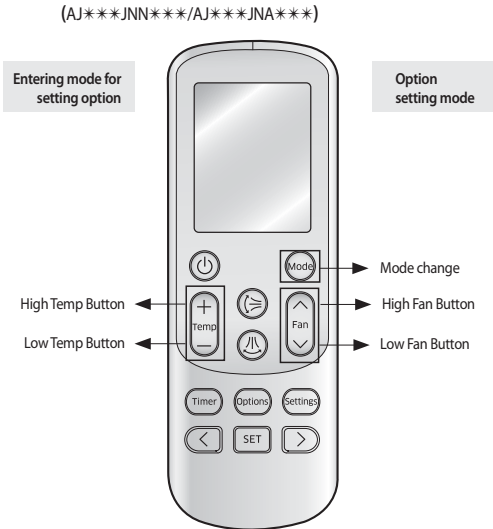

### ◆ Setting Option

1. Remove batteries from the remote controller
2. Insert batteries and enter the option setting mode while pressing High Temp button and Low Temp button.
3. Each time you press Low Fan button, 7-seg on left side is increased by "1" and each time you press High Fan button, 7-seg on right side is increased by "1"
4. You press **Mode** button to move to the next setting page.
5. After setting option, press **Mode** button to check whether the option code you input is correct or not.

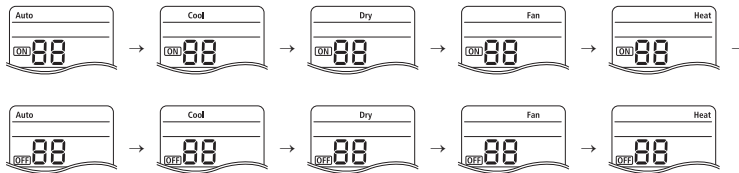



6. Press operation button (power) with the direction of remote control for set.



- SEG1, SEG7, SEG13, SEG19 are not set as page option.
- Set the SEG1, SEG7 as ON status and SEG13, SEG19 as OFF status.  
EX) Set the each option separately since you cannot set the ADDRESS setting and indoor unit installation setting option at the same time.

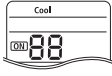
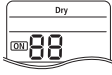
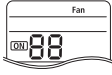
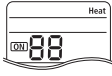
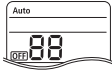
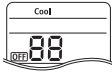
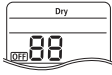

### The procedure of setting option

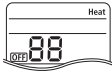
Operation	Indication
<p>* Step 1</p> <p>1. Remove the batteries from the remote controller.</p> <p>2. Insert batteries while pressing High Temp Button and Low Temp Button.</p>	
<p>* Step 2</p> <p>1. Press Low Fan button to enter SEG2 value.</p> <p>2. Press High Fan button to enter SEG3 value.</p>	
<p>* Step 3</p> <p>Press Mode button to be change to Cool mode in the ON status.</p> <p>1. Press Low Fan button to enter SEG4 value.</p> <p>2. Press High Fan button to enter SEG5 value.</p>	
<p>* Step 4</p> <p>Press Mode button to be changed to DRY mode in the ON status.</p> <p>1. Press Low Fan button to enter SEG6.</p> <p>2. Press High Fan button to enter SEG8.</p>	
<p>* Step 5</p> <p>Press Mode button to be changed to FAN mode in the ON status.</p> <p>1. Press Low Fan button to enter SEG9 value.</p> <p>2. Press High Fan button to enter SEG10 value.</p>	
<p>* Step 6</p> <p>Press Mode button to be changed to HEAT mode in the ON status.</p> <p>1. Press Low Fan button to enter SEG11 value.</p> <p>2. Press High Fan button to enter SEG12value</p>	
<p>* Step 7</p> <p>Press Mode button to be changed to AUTO mode in the OFF status.</p> <p>1. Press Fan button to enter SEG14 value.</p> <p>2. Press High Fan button to enter SEG15 value.</p>	
<p>* Step 8</p> <p>Press Mode button to be changed to Cool mode in the OFF status.</p> <p>1. Press Low Fan button to enter SEG16 value.</p> <p>2. Press High Fan button to enter SEG17 value.</p>	
<p>* Step 9</p> <p>Press Mode button to be changed to DRY mode in the OFF status.</p> <p>1. Press Low Fan button to enter SEG18 value.</p> <p>2. Press High Fan button to enter SEG20 value.</p>	
<p>* Step 10</p> <p>Press Mode button to be changed to FAN mode in OFF status</p> <p>1. Press Low Fan button to enter SEG21 value.</p> <p>2. Press High Fan button to enter SEG22 value.</p>	
<p>* Step 11</p> <p>Press Mode button to be changed to HEAT mode in the OFF status</p> <p>1. Press Low Fan button to enter SEG23 value.</p> <p>2. Press High Fan button to enter SEG24 value.</p>	
<p>* Step 12</p> <p>Press Mode button to check whether the option code you entered is correct or not.</p> <p>Press operation button to enter option.</p>	

# Setting an indoor unit address and installation option

## Setting an indoor unit address (MAIN/RMC)

1. Check whether power is supplied or not.
  - When the indoor unit is not plugged in, there should be additional power supply in the indoor unit.
2. The panel(display ) should be connected to an indoor unit to receive option.
3. Before installing the indoor unit, assign an address to the indoor unit according to the air conditioning system plan.
4. Assign an indoor unit address by wireless remote controller.
  - The initial setting status of indoor unit ADDRESS(MAIN/RMC) is "0A0000-100000-200000-300000"
  - There is no need to assign extra ADDRESS for 1:1 installation between indoor unit and outdoor unit.

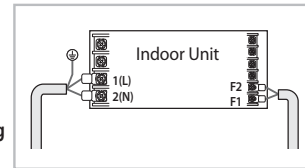

Option No. : 0AXXXX-1XXXXX-2XXXXX-3XXXXX

Option	SEG1		SEG2		SEG3		SEG4		SEG5		SEG6			
Explanation	PAGE		MODE		Setting Main address		100-digit of indoor unit address		10-digit of indoor unit		A single digit of indoor unit			
Remote Controller Display														
Indication and Details	Indication	Details	Indication	Details	Indication	Details	Indication	Details	Indication	Details	Indication	Details		
	0		A		0	No Main address			0~9	100-digit	0~9	10-digit	0~9	A single digit
					1	Main address setting mode								
Option	SEG7		SEG8		SEG9		SEG10		SEG11		SEG12			
Explanation	PAGE				Setting RMC address				Group channel(*16)		Group address			
Remote Controller Display														
Indication and Details	Indication	Details	Indication	Details	Indication	Details	Indication	Details	Indication	Details	Indication	Details		
	1				0	No RMC address					RMC1	1~F	RMC2	1~F
					1	RMC address setting mode								

You must set RMC address setting mode when using the centralized Control .



When "A"~"F" is entered to SEG4~6, the indoor unit MAIN ADDRESS is not changed.  
 -If you set the SEG 3 as 0, the indoor unit will maintain the previous MAIN ADDRESS even if you input the option value of SEG4~6.  
 -If you set the SEG 9 as 0, the indoor unit will maintain previous RMC ADDRESS even if you input the option value of SEG11~12.

- The MAIN address is for communication between the indoor unit and the outdoor unit. Therefore, you must set it to operate the air conditioner properly.

### Setting an indoor unit installation option (suitable for the condition of each installation location)

- Check whether power is supplied or not.  
 -When the indoor unit is not plugged in, there should be additional power supply in the indoor unit.
- The panel(display) should be connected to an indoor unit to receive option.
- Before installing the indoor unit, assign an option to the indoor unit according to the air conditioning system plan.  
 -The default setting of an indoor unit installation option is "02000-100000-200000-300000".  
 -Individual control of a remote controller(SEG20) is The function that controls an indoor unit individually when there is more than one indoor unit.
- Set the indoor unit option by wireless remote controller.  
 -When entering Address option, connect remote controller receiver.

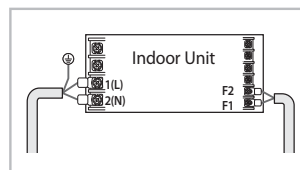

Option	SEG1		SEG2		SEG3		SEG4		SEG5		SEG6	
Explanation	PAGE		MODE						Central control			
Indication and Details	Indication	Details	Indication	Details	Indication	Details	Indication	Details	Indication	Details	Indication	Details
	0		2		0		0		0	0	No use	0
										1	Use	
Option	SEG7		SEG8		SEG9		SEG10		SEG11		SEG12	
Explanation	PAGE										Master / Slave	
Indication and Details	Indication	Details	Indication	Details	Indication	Details	Indication	Details	Indication	Details	Indication	Details
	1		0		0		0		0		0	Slave
											1	Master
Option	SEG13		SEG14		SEG15		SEG16		SEG17		SEG18	
Explanation	PAGE		External control		External control output				Buzzer			
Indication and Details	Indication	Details	Indication	Details	Indication	Details	Indication	Details	Indication	Details	Indication	Details
	2		0	No use	0	Thermo ON	0		0	Use	0	
		1	On/Off control									
		2	Off control	1	Operation ON			1	No Use			
		3	Window On/Off control <sup>1)</sup>									
Option	SEG19		SEG20		SEG21		SEG22		SEG23		SEG24	
Explanation	PAGE											
Indication and Details	Indication	Details	Indication	Details	Indication	Details	Indication	Details	Indication	Details	Indication	Details
	3		0		0		0		0		0	

If you input a number other than 0~4 of the individual control of the indoor unit(SEG20), the indoor is set as "indoor 1".

- The window on/off function applies to the following unit  
 - AJ\*\*\*JNN\*\*\*/AJ\*\*\*JNA\*\*\*

# Setting an indoor unit address and installation option

It could take maximum 60 minutes to operate for the protection of the compressor, if the outdoor temperature is below -5°C.

## Ampere Limit Setting & Changing Procedure



- ◆ Do not adjust the "Ampere Limit Switch", if it's not necessary : before modifying it, evaluate the total number of electric and electronics loads consumption and use "Ampere limits switch" just as emergency solution or in case the system is anyway oversized compared to real thermal load needed.
- ◆ "Ampere Limit Switch" is initially set to the default value (table below).
- ◆ "Ampere Limit Switch" is on the PCB of outdoor unit.
- ◆ Contact the authorized service technician or dealer for setting and changing the "Ampere Limit Switch".
- ◆ Before changing the "Ampere Limit Switch", turn off the main power of the system.

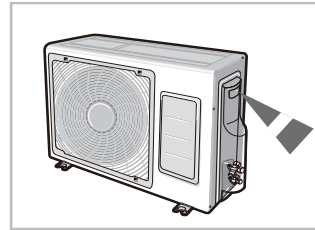

The designs and shape are subject to change according to the model.

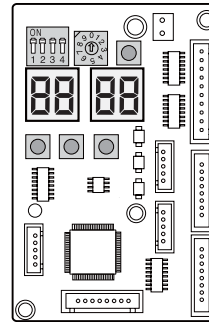

Display of the external unit

			Switch Selection	
AJ020JCJ2CH	AJ024JCJ3CH	Switch	3	4
14.0A (Default)	16.6A (Default)		ON	ON
13.0A	14.0A		ON	OFF
10.0A	11.0A		OFF	ON
8.5A	10.0A		OFF	OFF

**Settings of PCB Display of the Outdoor unit**

◆ Key Options of PCB Display

- K1 : pipe checking operation button
- K2 : Function button
- K3 : Reset button
- K4 : View mode change button

Key / Push	K1	K2	K3	K4
1	Pipe Checking Operation (Display: F5)	Heat Mode Try run (Display: F1)	Reset	View mode change
2	-	Refrigerant Charging (Display: F2)		
3	-	Cool Mode Try run (Display: F3)		
4	-	Pump down (Display: F4)		

Heat and Cool Mode Try run functions are just For Service Technician

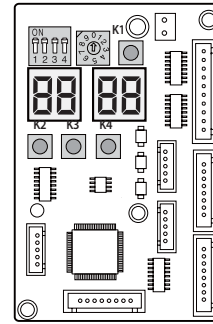

Display of the external unit

During the initial 60 seconds, display 1 shows in sequence: 00 01 02 ...15 00...

◆ K4 View mode Display changes

Push	Display Explanation	Push	Display Explanation
0	Present Compressor Frequency	8	Discharge temperature
1	Target Compressor Frequency	9	OLP temperature
2	Order Compressor Frequency	10	Condenser temperature
3	EEV0 current step	11	Outdoor temperature
4	EEV1 current step	12	Running current
5	EEV2 current step	13	Target Discharge temperature
6	EEV3 current step3	14	Total capacity of the indoor units
7	Fan RPM (H: high, L: low, Blank: off)	15	Safety Control (just For Service Technician)

The EEV 2 and EEV 3 of AJ020JCJ2CH are always displayed as blank.

The EEV 3 of AJ024JCJ3CH is always displayed as blank.

# Troubleshooting

The table below give indication about self diagnostic routine. Some of error code requires activities exclusively for Authorise Service Center.

The error indicated on the PCB display of outdoor unit

DISPLAY	EXPLANATION (The error indicated on the PCB display of outdoor unit)	REMARK
E1 01	Communiaction error(indoor unable to receive data)	Check electrical connection and setting
E1 02	Outdoor unit communication error(Abnormal data from indoor unit over 60 packet)	Check electrical connection and setting
E1 21	Indoor unit room temperature sensor error (Open/Short)	
E1 22	Indoor unit heat exchanger in temperature sensor error (Open/Short)	
E1 23	Indoor unit heat exchanger out temperature sensor error (Open/Short)	
E1 28	Indoor unit sensor error-Evaporator pipe in sensor - Self diagnosis	
E1 29	Indoor unit sensor error-Evaporator pipe out sensor - Self diagnosis	
E1 54	Indoor Unit FAN Error	
E1 61	More than two indoor units cool and heat simultaneously	
E1 62	Indoor Unit EEPROM Error	
E1 63	Indoor Unit EEPROM Option Error	
E1 71	EVA-MID BREAK AWAY	
E1 72	EVA-IN BREAK AWAY	
E1 73	EVA-OUT BREAK AWAY	
E1 90	Failure of pipe check operation	Check piping connection and setting
E1 99	No pipe check operation check -occasion : try to operation after the installation through auto addressing mode without pipe check operation.	Check setting
E2 01	The number of Indoor unit mismatched	Check electrical connection and setting
E2 02	Communication error between the outdoor and indoor unit	Check electrical connection and setting
E2 03	Outdoor communication error between main micom and inverter micom	
E2 06	Outdoor communication error between main micom and hub micom	
E2 21	Outside temperature sensor error(Short/Open) - Error level: over 4.9V(-50°C) under 0.4V(93°C)	
E2 37	Condenser temperature sensor error(Short/Open) - Error level: over 4.9V(-50°C) under 0.4V(93°C)	
E2 46	Outdoor unit sensor error - Condenser out sensor(Short/Open) - Self diagnosis	
E2 51	Compressor Discharge temperature sensor error	
E2 61	Compressor discharge sensor detached - Self diagnosis	
E3 20	Compressor OLP sensor error (Short/Open) - Error condition : outdoor temperature under -20°C - Error level : over 4.95V(-30°C) under 0.5V(151°C)	
E3 30	Evaln1 Sensor Short/Open	
E3 31	Evaln2 Sensor Short/Open	
E3 32	Evaln3 Sensor Short/Open	
E3 33	Evaln4 Sensor Short/Open	
E3 34	Evaln5 Sensor Short/Open	
E3 35	EvaOut1 Sensor Short/Open	

DISPLAY	EXPLANATION (The error indicated on the PCB display of outdoor unit)	REMARK
E3 36	EvaOut2 Sensor Short/Open	
E3 37	EvaOut3 Sensor Short/Open	
E3 38	EvaOut4 Sensor Short/Open	
E3 39	EvaOut5 Sensor Short/Open	
E4 01	Outdoor unit freezing(Compressor stop)	check pipe length, indoor unit filter, refrigerant leakage/charge and service port
E4 04	Outdoor unit overload - Safety control(Compressor stop)	check pipe length, refrigerant leakage/charge
E4 16	Outdoor unit high discharge temperature - Safety control (Compressor stop)	check pipe length, refrigerant leakage/charge
E4 19	Outdoor unit EEV open (Stopped indoor unit's) -Self diagnosis	
E4 22	Outdoor unit EEV open (operating indoor unit's) -Self diagnosis	
E4 40	High temperature(over 30°C) of outdoor as heating mode	
E4 41	Low temperature(under -10°C) of outdoor as cooling mode	
E4 58	Outdoor Fan Error	
E4 60	Communication cable mismatched between indoor and outdoor unit	Check electrical connection
E4 61	Inverter compressor starting failure (5 times)	
E4 62	Compressor trip by input current control mode (PFC over current)	
E4 63	Compressor trip by OLP temperature control mode	
E4 64	Over current	
E4 65	Compressor Vlimit Error	
E4 66	DC link Voltage error (under 150V, over 410V)	
E4 67	Abnormal compressor running (Compressor Rotation Error)	
E4 68	Current sensor error	
E4 69	DC link Voltage sensor error	
E4 70	Outdoor unit EEPROM Error	
E4 72	Inverter micom zero-crossing error	
E4 83	Over voltage Error	

## Explaining operations to the owner

---

Before leaving the premises on which you have installed the air conditioner, you should explain the following operations to the owner, making reference to the appropriate pages in the owner's instruction booklet.

1. How to start and stop the air conditioner.
  2. How to select the operating mode and adjust the temperature and fan settings.
  3. How to adjust the air flow direction.
  4. How to set the timers.
  5. How to remove and clean the filters.
- » Once the owner is happy with the basic operations, hand over the owner's instruction booklet and this installation manual for storage in a handy and safe place.



## Pump down procedure(when removing the product)

---

1. Turn on the air conditioner and select Cool mode or pump down mode to run the compressor for 3 minutes.
2. Release the valve caps on High and Low pressure side.
3. Use L wrench to close the valve on the high pressure side.
4. Approximately 2 minutes after, close the valve on the low pressure side.
5. Stop operation of the air conditioner.
6. Disconnect the pipes.



AJ\*\*\*JCJ2CH  
AJ\*\*\*JCJ3CH

# Air Conditioner installation manual

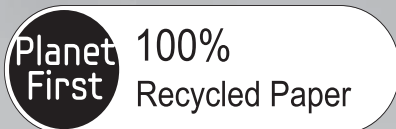

This manual is made with 100% recycled paper.

imagine the possibilities

Thank you for purchasing this Samsung product.



EN ES FR DB68-04989A-00

